

BARBARA CITY

THE

Lives of the Saints

BY THE

REV. S. BARING-GOULD, M.A.

New Edition in 16 Volumes

Revised with Introduction and Additional Lives of
English Martyrs, Cornish and Welsh Saints,
and a full Index to the Entire Work

ILLUSTRATED BY OVER 400 ENGRAVINGS

VOLUME THE SIXTEENTH

Appendix Volume

LONDON

JOHN C. NIMMO

NEW YORK: LONGMANS, GREEN, & CO

MDCCCXCVIII

BRITAIN IN 580.

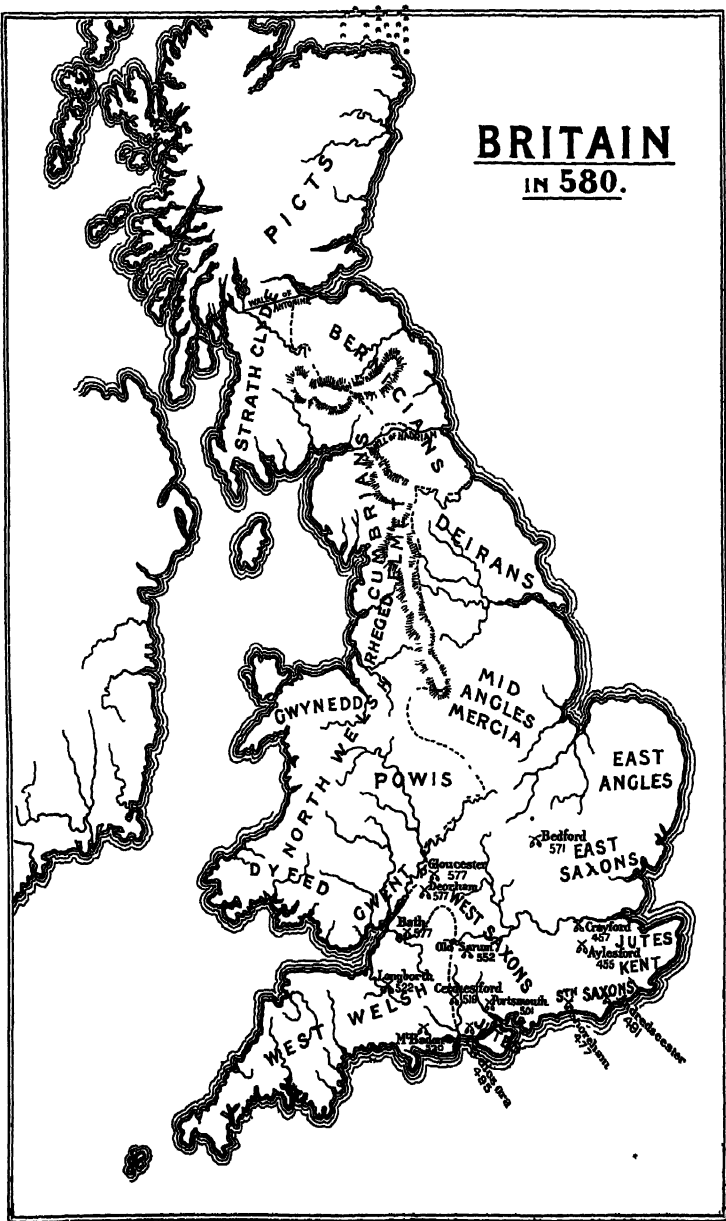

*This Volume contains TWO INDICES
to the SIXTEEN VOLUMES of the
work, one an INDEX of the SAINTS
whose LIVES are given, and the other
a SUBJECT INDEX*

THE
Lives of the Saints

REV. S BARING-GOULD

SIXTEEN VOLUMES

VOLUME THE SIXTEENTH

Appendix Volume

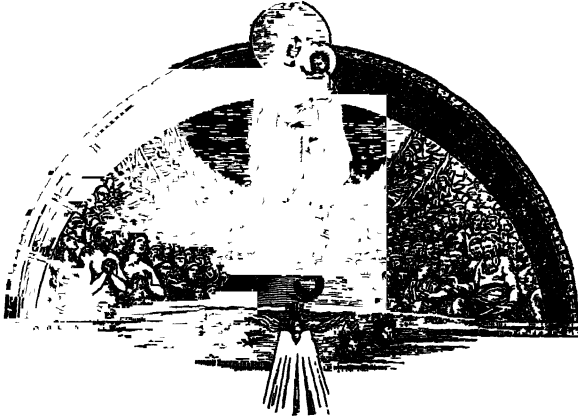

CONTENTS

	PAGES
THE CELTIC CHURCH AND ITS SAINTS	1-86
BRITTANY ITS PRINCES AND SAINTS . . .	87-120
PEDIGREES OF SAINTLY FAMILIES .	121-158
A CELTIC AND ENGLISH KALENDAR OF SAINTS PROPER TO THE WELSH, CORNISH, SCOTTISH, IRISH, BRETON, AND ENGLISH PEOPLE .	159-326
CATALOGUE OF THE MATERIALS AVAILABLE FOR THE PEDIGREES OF THE BRITISH SAINTS	327
ERRATA	329
INDEX TO SAINTS WHOSE LIVES ARE GIVEN	333
INDEX TO SUBJECTS	364

LIST OF ADDITIONAL LIVES GIVEN IN THE
 CELTIC AND ENGLISH KALENDAR

A		PAGE
S. Aaron		245
" Aelhaiarn		288
" Afan	. .	305
" Aidan		177
" Alburga		324
" Aldate	. .	179
" Alfred the Great	. .	285
" Alfric		305
" Almedha	. . .	258
" Amaethlu	. . .	325
" Armel	. . .	264
" Arnulf	. . .	268
" Austell	. . .	243
" Auxilius	. . .	275, 316
B		
S. Baithen or Baitan		232
" Barrwg or Barruc		317
" Beuno	. . .	214
" Birstan		294
" Bodfan		229
" Boethius		321
" Boisil	. . .	174
" Bregwyn	. . .	269
" Brunstan	. . .	294
" Bristan	. . .	294
" Brothen		281
" Brynach Wyddel		209
" Budoc	. . .	321
" Buith	. . .	321
" Buriانا	. . .	226
C		
S. Cadfan		288
" Cadoc	174,	325
" Cadwaladr	. . .	280
" Caian		276
S. Callwen		288
" Canog		279
" Caranog or Carantog		222
" Caron		193
" Cathan		222
" Catherine Audley		314
" Cawrdaf		319
" Ceadwalla		213
" Ceitho		287
" Celynn, son of Cynyr Farfdrwch		287
" Celynn, son of Helg		310
" Cewydd	. . .	245
" Cian		321
" Cledwyn		287
" Clement		197
" Clether	. . .	265
" Clydai		288
" Clydog	. . .	294
" Clydwyn		287
" Collen	. . .	223
" Colman	. . .	184
" Conan	. . .	176
" Conlaeth		195
" Constantine		198
" Conval	. . .	277
" Cowair	. . .	251
" Creirwy		192
" Crewenna	. . .	179
" Cristiolus		294
" Cumine the White		186
" Cungar	301
" Curig	236
" Cuthbert		285
" Cwyfan or Cwyfen		230
" Cwyllog	. . .	168
" Cybi	. . .	279
" Cynbryd	197

Contents

vii

	PAGE
S Cynddilg	293
„ Cyndeyrn	254
„ Cynfab	305
„ Cynfarch	272
„ Cynfarwy . . .	302
„ Cynfran . . .	303
„ Cyngar	301
„ Cynhafal	279
„ Cynidr . . .	216
„ Cynllo . . .	253
„ Cynog . . .	279
„ Cynwyl	217
„ Cynacus	236
„ Cywar	251
„ Cywyllog . . .	168

D

S. Dagæus	265
„ Dagan	228
„ David	187
„ Deghadh	265
„ Deifer	193
„ Deimol	Car-
penter	273
„ Deimol the Younger	313
„ Deimolen	313
„ Deimolfab	313
„ Derfel Gadarn	207
„ Deruvianus	221
„ Digam	310
„ Dihaer	193
„ Dihefyr	193
„ Dingad	287
„ Docmael	234
„ Doewan	252
„ Dogfan	252
„ Dogmael	234
„ Dogwan	252
„ Domneva	309
„ Dona	293
„ Drostan	322
„ Dubricius	304
„ Dubricius, Transla-	
tion of	228
„ Dubtach	280

	PAGE
S Dunawd Fawr	272
„ Dunchad	201
„ Dwyrwen	175
„ Dyfan	221
„ Dyfnan	216
„ Dyfnog	183
„ Dyfiig, Translation	
of	228
SS Dyfrwyr, the	292

E

S. Eadburg	235
„ Eadfrid	284
„ Eadsin	285
„ Ealsitha	253
„ Easterwin	193
„ Edbeit	266
„ Edburga	235
„ Edeyrn	168
„ Edmund, C	278
„ Edmund, K.M	310
„ Edwen	297
„ Efflam	297
„ Egbert	309
„ Egelwin	318
„ Eigrad	167
„ Einion	180
„ Elaeth the King	303
„ Eldad	179
„ Elian Geimad	170
„ Elined	258
„ Elhdrius	259
„ Elstan	208
„ Enghenedl	278
„ Enoder or Cymdr	216
„ E1bin	170, 228
„ Erfyl	248
„ Erme	264
„ Ermel	264
„ Ermenburga	309
„ Ermengytha	257
„ Ernan	161
„ Etheldwitha	253
„ Ethelgiva	321
„ Ethelhard	221

	PAGE		PAGE
S Ethelnoth . . .	286	S Gwodloew . . .	211
" Ethelwin . . .	219	" Gwernerth . . .	210
" Eurfyl . . .	248	" Gwryd . . .	293
" Eurgain . . .	244	" Gwynan . . .	322
" Eval or Evail . . .	310	SS Gwyn and comp . . .	287
		S. Gwynhoedl o1 . . .	
F		Gwynodl . . .	159
S Failbhe I. . .	197	" Gwynlleu . . .	288
" Failbhe the Little . . .	194	" Gwynno . . .	287
" Fergna the White . . .	188	" Gwynnog . . .	284
" Ffagan . . .	259	" Gwynno10 . . .	287
" Ffinan . . .	322	" Gwynws . . .	322
" Fflewyn . . .	321		
" Finan, or Finian, . . .		H	
the Leper . . .	196	S Hychan . . .	259
SS Fingar and Piala . . .	198	" Hydroc . . .	220
S. Finian . . .	272	" Hywyn . . .	167
" Fothadh II . . .	179		
" Frthebert . . .	323	I	
" Frtheistan . . .	273	S. Idloes . . .	271
		" Illog . . .	259
G		" Iltut o1 Illtyd . . .	249
S. Galgo . . .	316	SS. Indract and com- . . .	
" Geraint or Geron- . . .		pany . . .	220
tius . . .	260	S Ismael . . .	235
" Germoc or Germoe . . .	240	" Isserninus . . .	316, 318
" Gisthan . . .	191	" Ita or Ytha . . .	171
" Gluvas or Glywys . . .	219		
" Gofor . . .	220	J	
" Gorwst . . .	318	SS Jacut, Gwethenoc, . . .	
SS Grace and Probus . . .	208	and Creirwy . . .	192
S Gredifael . . .	304	S. Jambert . . .	263
" Grwst . . .	318	" Joavan . . .	188
" Guinock . . .	211	" Julius and Aaron . . .	245
" Gundleus or Gwyn- . . .		" Jurmin . . .	186
llyw Filwr . . .	202	" Just . . .	264
" Guron or Goran . . .	210	" Justinian . . .	320
" Gurwal . . .	230	" Justus . . .	303
" Gwen of Cornwall . . .	282	" Jutwara or Jutwell . . .	252
" Gwen of Wales . . .	282		
" Gwenfaen . . .	296	K	
" Gwenfyl . . .	288	S Katherine Audley . . .	314
" Gwenog . . .	165	" Kay . . .	294
" Gwerir or Guer . . .	207	" Kea . . .	294
" Gwethenoc . . .	192		

Contents

ix

	PAGE
S Kenan . . .	294
" Kennotha or Kevoca	195
" Kentigierna	169
" Kevern . . .	305
" Kieran	192
" Kigwve or Kywa	180

L

S Leonore	246
" Levan or Levin	231
" Lewina . . .	254
" Llechid . . .	319
" Lleuddad	172
" Llbio . . .	187
" Llwhaiarn	169
" Llywelyn and Gwr- nerth . . .	210

M

S Mabenna . . .	276
" Mabyn . . .	276
" Machan	277
" Machraith	161
" Machudd	305
" Macwaloc . . .	176
" Mael or Mahael	221
" Maelog . . .	326
" Maelrubh	215
" Maelrys	159
" Maethlu	325
" Mauldulf or Maudulf	213
" Malo . . .	304
" Manaccus	281
" Marcella . . .	271
" Marchell . . .	271
" Marnan or Marnock	188
" Marnoc or Marnan	283
" Materiana . . .	210
" Mathernus or Mad- ron . . .	222
" Maudez . . .	306
" Maughan . . .	277
" Mawes . . .	306
" Mawgan or Meugant	277
" Mechell . . .	305

VOL. XVI

	PAGE
S Medana . . .	308
" Meigan . . .	277
" Meiron . . .	179
" Melangell or Mona- cella . . .	225
" Melanius . . .	296
" Melor . . .	162
" Merewenna, V. Rum- sey . . .	221
" Merewenna, V. Mar- hamchuich . . .	263
" Meriadoc . . .	231
" Mern or Meilyn . . .	167
" Meugant . . .	277
" Mevan . . .	238
" Minver oi Mene- fieda . . .	314
" Moloc or Mo-luoch	240
" Monan or Moinen	188

N

S. Nectan . . .	238
" Nidan . . .	278
" Non or Nonnita	189
" Nothelm . . .	282
" Nwython or Noethan	283

P

S. Pabo Post Prydan	302
" Padarn . . .	289
" Pandwynna . . .	268
" Patrcian . . .	316
" Paul, Bishop of Léon	195
" Paulinus . . .	311
" Peblig or Publicius	248
S Peithian . . .	176
" Peuln . . .	311
" Plegmund . . .	258
SS Probus and Grace .	208

R

S Rhediw . . .	303
" Rhian . . .	194
" Rhuddlad . . .	271
" Rhwydrys . . .	287

b

	PAGE		PAGE
S. Richard Rolle	277	S. Tudur	281
„ Rioch	182	„ Tudy	274
„ Robert	202	„ Tugdual	318
„ Ronan	180	„ Turgot	206
„ Rumon, Roman, or		„ Twrog	243
Ruan	165	„ Tybie	176
„ Rumwold	269	„ Tydecho	322
„ Rychwyn	233	„ Tydfyl	268
		„ Tyfaelog	187
S		„ Tyfer	202
S. Sadwrn Farchog	317	„ Tyfrydog	160
„ Samson	254	„ Tyssul	177
„ Sawyl Benuchel	172		
„ Scothin	161	U	
„ Secundinus	316	S. Ulched	168
„ Seiriol	162	„ Ust	264
„ Senan	194	„ Uvellus	310
„ Sennan or Senanus	233		
„ Sidwell or Sativola	258	V	
„ Sigfrid	267	S. Veep, Wymp, or	
„ Solomon or Selyf	241	Wennapa	246
„ Stinan	320	„ Veho or Vougo	234
„ Sulien or Silm	270	„ Voloc or Macwoloc	176
T		W	
S. Talarican	286	S. Walstan	228
„ Tanwg	280	„ Wennapa	246
„ Tathan or Tathæus	324	„ Wilfrid II	217
„ Tecwyn or Tegwyn	274	„ Wilgis	177
„ Tegla or Theckla	229	„ William	225
„ Teilo	181	„ Winoc or Guinock	211
„ Tenenan	253	„ Winwaloe	190, 217
„ Ternan or Torannan	233	„ Withburga	251
„ Teyrnog or Tyrnog	207	„ Wulfhulda	272
„ Thomas à Becket	326	„ Wymp	246
„ Trillo	234		
„ Tuda	183	Y	
„ Tudglyd	228	S. Ytha	171
„ Tudno	230		

LIST OF ILLUSTRATIONS AND MAPS

[Battlefields in the Maps are marked by Crossed Swords, and Abbeys by a +]

MAP OF BRITAIN IN 580 A D	<i>Frontispiece</i>
MAP OF BRITAIN IN 750 A D.	<i>to face p 1</i>
MAP OF CORNWALL IN THE SIXTH CENTURY, SHOWING BRECKNOCK - GWENTIAN AND IRISH COLONIES	" 16
MAP OF ANCIENT WALES	" 32
PLAN OF EARLY CELTIC MONASTIC SETTLE- MENT ON SKELLIG-MICHAEL, CO. KERRY	" 64
MAP OF BRITANNY, AFTER THE MIGRATIONS FROM BRITAIN	" 86
SAINT GWEN-TEIRBRON AND HER THREE SONS, MONUMENT IN BRITANNY	" 192
GWELY MELANGELL—ROCK BED OF S. MEL- ANGELL	" 224
TOMB OF S. PABO AT LLANBABO	" 302

BRITAIN IN 750.

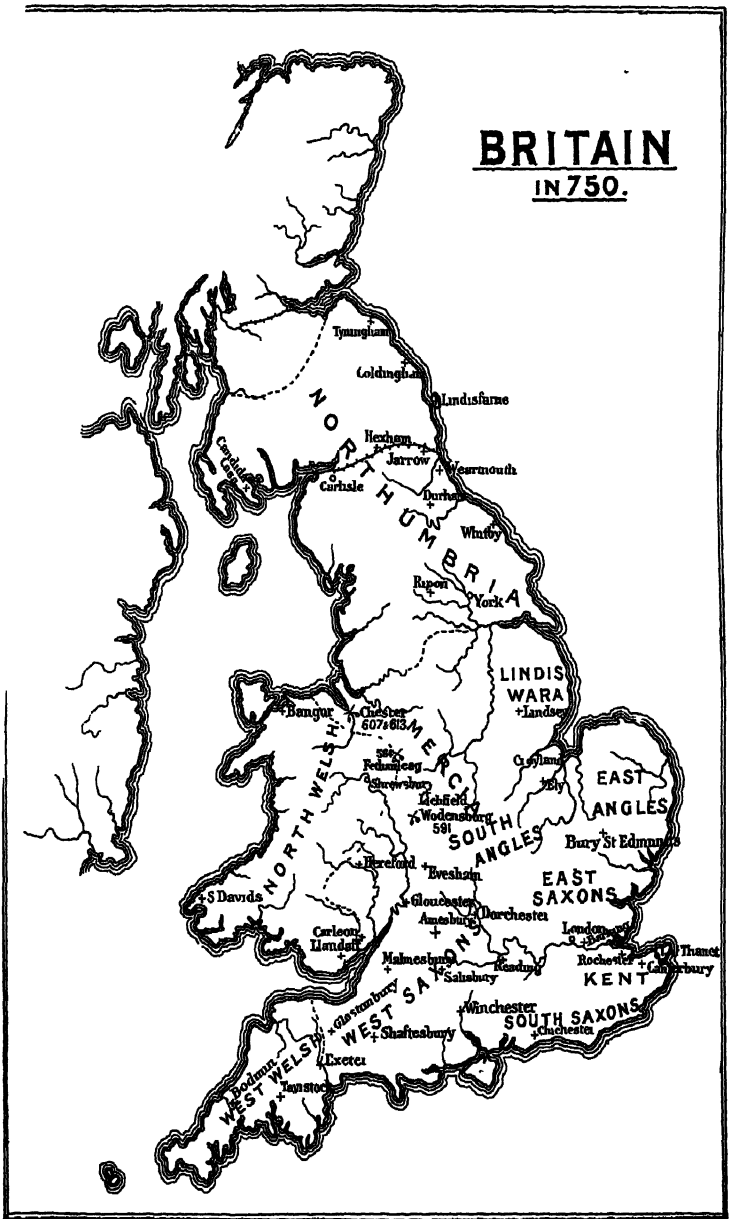

LIVES OF THE SAINTS

THE CELTIC CHURCH AND ITS SAINTS.



HE earliest inhabitants of the British Isles were those who in the sub-glacial period used rude chipped and flaked tools of flint and of bone, a people long-headed, tall, of a gentle and patient disposition, if one may judge by their remains. Whether they lingered on till the arrival of the dusky short race we call Ivernian, Iberian, or Silurian, we have no means of saying with any approach to certainty. But there still remain along our western coasts, at the Land's End, in Pembrokeshire, in old Strathclyde, in the Western Isles, men and women with long faces, and dark hair and eyes, of a handsome type, fondly supposed to be relics of Spaniards cast ashore from the Armada, who may with greater justice be regarded as survivals of the earliest type that occupied the British Isles.

But the race that prevailed was short of build, probably sallow, and with beady eyes. It is that which at a remote period covered the whole of Gaul, the north of Germany, the south of Sweden, and which arrived in Europe by the valley of the Kuban, north of the Caucasus, from the East. This people, which, wherever possible, erected megalithic monuments, symbols of its endurance

through all time, is the first of which we can speak with any degree of confidence. It was a race of inextinguishable vitality. It is still largely represented in Wales, and in Ireland, and in Lancashire. It has become the dominant type in Aquitania, if not throughout France. Pure and unalloyed, or nearly so, it remains in the Berber; dress a Kabyl in a French blouse, and he will not be distinguishable from a native of Guenne. The Portuguese also represents the same race. The language spoken by this people was probably agglutinative, like the Basque, it had not attained to that development in which inflection is found.

At some remote period, certainly not later than a thousand years before Christ, a Celtic invasion of Britain took place. The great nursery of this mighty people seems to have been the Alps. The migration which came into and occupied Britain was afterwards termed Goidelic. The Goidels possessed themselves of the whole of Britain and a portion of Ireland. They subdued, but by no means exterminated, the dusky race they found in possession. They imposed on them their Aryan tongue, but themselves adopted the religion and usages of the subjugated race.

How far the Goidels occupied Wales and South Britain is matter of dispute. Such an authority as Dr. Rhys holds that they completely subdued the Ivernians throughout Wales and Devon and Cornwall. This opinion is based, I believe, mainly on the Goidelic form of the inscribed stones there found. The place-names, however, bear hardly a trace of Goidelic idiom. The Goidel said *ken* for head, whereas the Brython said *pen*. With the former five was (O.I.) *coic*, and the latter *pump*; with the former *each*, a horse, the latter *ep*. Dr. Guest has given reasons for holding that the Volcæ of Southern Gaul, the Belgæ

of the Netherlands and Gaul, south and west of the Rhine, and the Fir-Bolgs of Ireland, were one with the Goidels.

In Scotland, north of the Antonine Wall, the Ivernians lived on unsubdued under the name of Pict, but with a large infusion of Goidelic blood. We find plenty of traces of Goidelic *kens* there, as we do in Ireland.

In or about the fourth century B.C. the whole of Europe, and indeed Asia Minor as well, were convulsed by another migration of Celts, whom the Alps could no longer contain. This was the Gallic wave, which in our island has taken the name of Brythonic. This wave overflowed all that portion of Gaul which lies between the Rhine and the Seine, and crossing into our island conquered the Goidel, who now acquired this name, expressive of contempt, as signifying the savage.¹ The new-comers were armed with weapons of iron, whereas those whom they subjugated were furnished with arms of bronze, bone, and stone.

Driving the Goidels before them, the Britons advanced till they reached the western sea, thrusting a wedge into Wales, and constituting the basis of what was afterwards known as the kingdom of Powys

Some must have crossed into Ireland, where they established themselves in what are now the counties of Wicklow, Wexford, and Carlow. Both Goidel and Brython, or Gael, spoke a language closely akin, but partly owing to separation through centuries, and partly through the alteration of Goidelic through contact with the Ivernian, there was a notable difference between the tongues when they met. In Wales, especially in the south, the Silurian, non-Aryan, tongue prevailed till the Roman conquest, and in Pictland till some centuries later.

The Britons occupied the entire east of Britain to the wall uniting the Firth of Forth with the Firth of Clyde.

¹ *Gwyddel* from *Gwydd*, trees, *gwyddels*, bushes, *gwyddehg*, sylvan, savage

This wall did not of course then exist, but later on it marked the limit of their conquest. They held the seaboard from the Solway Firth to the mouth of the Dee, and their tribe of the Ordovices, as already stated, had pierced the heart of Wales, and held the major portion of the coast of Cardigan Bay. At first they did not extend in the south-west, into Somerset and Dorset, but were able gradually and surely to roll back the natives or to enslave them.

The great cradle of the Celtic stock had been the highlands of the Alps, where, in a densely wooded region, there had been no need to use stone for building enclosures and houses. The custom grew up to live on platforms above the lakes, constructed of wood and on piles, and upon these platforms to plant clusters of hovels made of wood and wattle.

When the Goidelic branch arrived in Britain and in Ireland, and was brought into contact with the earlier race, that was emphatically one of builders, it viewed with amazement their achievements in the erection of megalithic monuments, and although subjugating them, acquired their civilisation and habits of life and religion. To a late period, even to Christian times, these Goidels constructed dwellings and forts after the pattern acquired from the Silurians, and to this day bee-hive huts in Wales are called "the hovels of the Goidels"

But the Britons were in a far higher condition of civilisation when they appeared on the scene in our island, as were the Gauls when they arrived in what we now call France. They knew how to make iron weapons, and they had acquired such dexterity in the construction of timber dwellings, and in palisading, that they felt no disposition to adopt the methods of the Goidels. The fortresses they erected were not mainly of stone, but were

earthworks crested with a stockade, and their houses, halls, and eventually their churches, were all constructed of wood.

It was the same with their religion; they exhibited no inclination to accept that which belonged originally to the Ivernians, and which had been adopted by the Goidels. Gauls and Brythons had advanced from mere spirit worship, the cult of the dead, to the worship of elemental deities. They burned their dead, but did not make for them rude stone cists, set up circles, nor construct dolmens.

In one particular, and in one only, were the Ivernians their superiors—this gifted race had always been one of builders. They not only erected gigantic monuments for their dead, but were able to construct stone circular habitations for themselves, and to throw up around them great stone fortifications. From them their Goidelic conquerors had acquired the art. But the Brythons would none of it. They showed to the last a really astounding incapacity to build. Accustomed on their platforms above the lakes in Switzerland to live in wattled hovels, they brought with them extraordinary skill in plaiting and weaving, and contented themselves with dwellings made of wattles, and for protection they threw up earthworks, and crested them with interwoven work of palisades and willow wands. The exquisite interlaced work that ornaments their monuments and decorates Irish manuscripts is due to this hereditary love of lattice.

The Roman conquest of Britain was mainly one of the Brython, at least at first; but after Agricola's defeat of the Silurians, Roman civilisation penetrated into Wales, where the conquerors worked the gold mines whence the Silurian had for long derived the most precious metal.

It may be suspected that the Romanised Britons lost most of their vigour, as they did of their independence,

when they received a veneer of Roman culture. The imperial system, if it had not destroyed, had weakened that tribal cohesion under hereditary chiefs which was the form of national organisation to which they had developed when the iron hand of Rome smote them and arrested the natural and logical growth of their free institutions in accordance with the genius of the race. The people were forced by three centuries of Roman domination to obey the governor sent them from abroad, and not their native chief. And when the Roman legions were withdrawn, that organisation which would have mustered them and compacted them to form a front against the enemy was but a shadow of what had once been a reality. Buffeted on the east by the Saxons, on the north by the Picts, exposed on the west to the Irish Goidels, they were no longer in a position to help themselves.

Julius Cæsar had invaded Britain in 55 B.C., and again in the ensuing summer; but really nothing was done to subjugate the island till Aulus Plautius was despatched to it in A.D. 43, at the head of four legions and Gallic auxiliaries. Under Ostorius Scapula, A.D. 50, further advance was made, but the Silures and the Ordovices held out, and it was not till after nine years of warfare that the gallant Caradoc, prince of the Silures, but of Celtic origin and family, was finally defeated and taken. Suetonius Paulinus, in A.D. 58, was appointed, and after three years of successful warfare reduced Mona, the stronghold of the Druids. But the man who finally established the dominion of the Romans in the island was Agricola, who governed it from 78 to 85.

Britain enjoyed comparative tranquillity under the Roman rule till the decline of the Empire.

The incursions of the Picts from Caledonia was probably due to their eastern coast being itself infested with

practical attacks of Saxons, and settlements in their land. The Picts broke over the wall, and swept the helpless country with fire and sword. The Irish Gwyddel Ffichti at the same time gave great trouble. They were not pirates only, carrying off slaves, but colonists as well, and they took possession of North Wales; others again penetrated to, and established themselves in, Brecknock

At the same time that the Britons became Romanised they were also Christianised. When, about A.D. 208, Tertullian wrote "against the Jews," he declared that the Gospel message had been conveyed to the boundaries of Spain, to the many tribes of the Gauls, and into the districts of the Britons inaccessible to the Romans. By this he doubtless meant that it had penetrated beyond the wall among the Picts of Alba, and beyond the Romanised Britons among the "savages" of Western Britain. His testimony is confirmed by Origen in 239, and later, about 246, Origen speaks of the British Church as small and weak, "for very many in Britain," he tells us, "had not yet heard the word of the Gospel."

Oratorical although these passages may be, we are not at liberty to reject them; for that they are too precise. And, indeed, that there should be truth in the statement is by no means improbable. The Roman legions were recruited from every part of the world, and among the soldiers were many who believed in Christ, and who would act as missionaries wherever sent. Soldiers transplanted from Asia Minor, which in the third century was filled with flourishing churches, would be settled in Britain for many years. A cohort drawn from Spain, where the faith of Christ had obtained root and had spread, was, we know, quartered for half a century on the frontier, in defence of the wall against the inroads of the Caledonians, and the soldiers married there and had families.

Indeed, it would be incredible, knowing as we do how Roman cohorts were drafted from all parts, and knowing also what a nursery of martyrs the army was, that Christianity should not have been introduced by its means into Britan at an early period. The only martyrs of whom reminiscence remains were Alban of Verulam, Julius and Aaron of Caerleon, and Amphibalus of Redbourn, near S. Albans. Nennius, in or about 858, names Alban, but makes a geographical mistake, for he describes the Thames as flowing near Verulam. This, however, does not invalidate his testimony, for he had not been in that portion of England which was the scene of the martyrdom, and maps were not accessible in those days. Alban suffered in 303, at a place which in time was so surrounded with Saxons that no Briton could go near it. The tradition lingered on, but veneration for the site ceased. Bede, who died in 735, knew of the martyrdom; he heard of it from the British of Strathclyde, Nennius probably from Wales.

It has been pointed out that the names of Aaron and Julius, as also of Amphibalus, are foreign, and have no equivalents in Welsh

The sites of the martyrdom of the two former were marked from an early age at Caerleon, and it is significant that on the height above that ancient metropolis a *martyrium* to S. Alban was erected, the traces of which still remain, erected doubtless after the Britons had been driven from Verulam, when it would seem they took the bones of the martyr with them. This, at a later period, led to the claim of Caerleon to have been the scene of his passion, and not Verulam. It is probable that Aaron and Julius were soldiers belonging to the second legion, which was quartered at Caerleon, or Isca Silurum. It is very difficult to suppose that a cult should have grown up out of nothing in a place where tradition remained strong, and

from which the hold of the Briton was never wholly relaxed.

Constantius Chlorus, father of Constantine, disapproved of persecution, and from his time to about 368 there is no record of anything taking place in Britain. At that date Magnus Clemens Maximus, a Spanish soldier, served in a campaign against the Picts. According to Welsh accounts he was given a command in Wales, where he ruled with great humanity, and was much liked. He married Elen, daughter of Eudaf (Octavius), prince of Ewyas, or part of Monmouth and Hereford, and by her he had three sons, saints, so that, doubtless, he was a Christian. To Elen is attributed the remarkable road, the Sarn Helen, that runs through Wales. A fourth son of Maximus and Elen, Constantine, is not supposed to have possessed distinguished sanctity

The predilection of the Emperor Gratian for foreign barbarians excited discontent among the legions in Britain, and perhaps served them as an excuse for revolt, whereupon Maximus was proclaimed emperor in 383. He immediately collected all the troops stationed in Britain and crossed into Gaul. Gratian was defeated near Paris, and was slain when escaping into Italy. Gaul, Spain, and Britain now acknowledged Maximus, who exhibited commendable moderation in the use of his power, and was able to boast that his elevation had caused no loss of Roman lives, save on the battlefield. He fixed his court at Trèves, and there, professing his orthodoxy, acquired the disgraceful notoriety of being the first Christian sovereign to shed the blood of his subjects for holding heretical opinions. This was in 385, and the case is related in the life of S. Martin (November, p. 254). Maximus induced his brother-in-law, Cynan Meriadog, to lead an army of picked British soldiers to his assistance, to the number, it is said, of 60,000 men,

and these never returned, but settled in Armonica. This emigration drained Wales of her best fighting men, and paved the way to disaster

Maximus, having been defeated by Theodosius the Younger, lost his life, along with his son Victor, A.D. 388. On the tidings of his death reaching Britain his son Owain was elevated to be king, or pendragon, over the native princes. At this time the Empire was breaking up, communication with Britain was intercepted, and in 402 the Roman army of occupation in the island was reduced from three to two legions, one of which still remained at Isca Silurum, or Caerleon.

Wales had been depleted of her fighting men, at all events of British origin, who had gone with Cynan Meirriadog to Brittany in support of Maximus, A.D. 385, and as Gildas informs us, "they never returned." But this was not all. "A few years later," says William of Malmesbury, "a certain Constantine (the Tyrant), likewise seduced by the title of Emperor, drew away with him to the Continent the few soldiers who remained in the isle of Britain. But these two usurpers, toys of fortune, perished by a violent death, one in the reign of Theodosius, the others by order of Honorius. Of the troops that had followed them, one portion was cut to pieces, and the other took to flight, and found refuge among the Continental Britons."

This Constantine the Tyrant was a common soldier in the Roman army stationed in Britain. In 407 these troops rebelled, and chose Constantine to be emperor, for no other reason but for the fact that he bore the venerated and royal name of the great emperor. He carried his legions over into Gaul, and was recognised in nearly every province before the year had elapsed. He was ably assisted by Geraint, or Gerontius, a Briton, probably from Dyfnant, of the royal family there. There can be little doubt that

he took with him levies from Britain. Owing to disappointment and disagreement Gerontius, in his turn, revolted against Constantine, but was deserted by his men, and fled to Spain, where he killed himself. To some extent it was due to this drain of fighting men from Britain that the country was left a prey to the Gwyddel Ffichti, or Irish Picts, as well as to the Picts of Alba and to the Scots, who poured over the undefended wall. Niall of the Nine Hostages, at the head of a host of Irish, occupied Gwynedd, or North Wales, also the district of Menevia, and what was later Cardigan and Pembrokeshire were occupied. Another Irish rover, Anlach MacCormac, settled with a body of his Goidels in Brecon, and took to wife a native princess, by whom he became the father of Brychan, the famous king of Brecknock, the father of a family of saints that founded churches alike in Wales and Cornwall. Another of these adventurers, Coroticus, carried off S. Patrick to sell him as a slave in Ireland. Some think he was captured at Boulogne, others that he was taken from Dumbarton, and others again claim him as a native of Wales.

In the same way, colonies of Goidelic Picts from Ireland descended on the coasts of Cornwall and Devon, and established themselves there, not only appropriating the temporal sovereignties, but appropriating as well the religious jurisdiction, forming, in fact, military and ecclesiastical settlements in the peninsula. It is to this Irish Goidelic invasion that are due, if I mistake not, the inscribed stones in Wales and Cornwall that have legends in non-Brythonic forms.

This invasion of the Irish Picts introduced a number of saints into the kalendars of Wales and Cornwall. But it did more than this, it familiarised Welshmen and Cornish men and Devonians with the great saints of Ireland. But more than this even, it caused the British Church

to be the mother of the Irish Church, which in time gave birth to that of Scotland, and then to that of Northumbria.

The wretched and incapable Honorius, who died in 427, withdrew the legions from Britain, and abandoned the natives, who had been enervated by the sway of Rome, to become the prey to foreign foes

One might have supposed that in the three centuries during which the Britons had been under Roman rule they would have observed the methods of construction of the Romans, have noted their discipline, and that at least they would have at once combined to rebuild the walls of the fortified cities, and to discipline their armies on the model of the Roman legions. But they did nothing of the sort. They had acquired little of Roman art, nothing of Roman discipline. In defending themselves against Pict and Scot they reverted to native and primitive methods. There is not a shadow of evidence that they repaired the broken walls, or erected others on the models they had before them. Their warfare was conducted in as ignorant and ineffectual a manner as if they had learned nothing from the legions who had been in their midst. The explanation is this. A large number of the ablest-bodied men of Britain were annually enrolled and sent abroad to act as legionaries in countries far removed from Britain, to which they never returned, consequently the Britons in Britain received no military education. Moreover, their native political institutions were struck with paralysis. The tribal chiefs were for two or three centuries left as mere headpieces, through whom the poll-tax could be levied, but who had lost all but the mere semblance of power.

When the Saxons and Angles arrived on our coasts they were in the same stage of political evolution in which the Britons had been when subjugated by the Romans. They

at once, with rapidity, advanced from this inferior stage of organisation to one higher, out of the tribal condition into national cohesion ; and this was at the time when the unfortunate Britons were recovering from political paralysis, and revivifying institutions that had been formal and lifeless for at least two centuries, and which, when re-animated, placed them on that inferior stage of organisation from which the Teutonic invader was emerging, his development having suffered no arrest. Already, before the invaders landed, the tribal system among them was yielding everywhere, and the Teutons were coalescing into articulate nationalities, as Allemanni and Franks, under kings. When the hordes reached British shores, in the face of the enemy defending their homesteads, they also drew together ; and Bede shows them to us in his day as grouped into the three great kingdoms of Northumbria, Mercia, and Wessex. The unhappy Britons, numbed by the oppression of Rome, could not cope with them, for theirs was the disorganisation of the tribal stage pitted against the organisation of national life.

The first arrival of the Jutes in Britain was in A.D. 449, when they were invited by Vortigern, the British over-king, to assist him against the Picts and Scots. They encamped in Thanet, aided the Britons in more than one campaign, but owing to a dispute over pay and rations broke with those who had invited them, and in 455 crossed the Wantsum, that separated the islet from the mainland of Kent, and surprised the Britons and defeated them. They proceeded to sack Durovernum, now called Canterbury, and crossing from the Stour valley into that of the Medway, again defeated the Britons at Aylesford and at Crayford, and drove them within the walls of London.

The indignation and resentment of the Britons found vent against the wretched Vortigern, who had opened the

door to a worse enemy than Pict or Scot. A revolt ensued, in which the command of the British defenders was wrested from him and put in the hands of Aurelius Ambrosius, a Romanised Briton, and Vortigern died apparently of a broken heart, overwhelmed with contempt, in 464. Aurelius, called by the Welsh Emrys Wledig, met, however, with very little better success against the invaders.

In 477 Saxon war-bands under Ella landed in Selsey, and rapidly won the entire coast of what has since been called Sussex. In 491 ensued the siege of Anderda, a centre of the great iron industry. The Britons maintained a stubborn defence, and when finally the town fell the Saxons "slew all that were therein, nor was there henceforth one Briton left"

Other Saxons landed on the low muddy shores of the Colne and Maldon estuary and thence proceeded to attack and destroy Camalodunum, now called Colchester, a double city, one portion British, the other Roman; but, doubtless, since the Roman legions had withdrawn, the native Iceni had entered and occupied the stately and well-built Roman city, and had deserted their embankments and wooden houses at Lexden. The reduction of Essex followed. In 480 landed the Angles, and they speedily overran what is now called Norfolk and Suffolk. Within thirty years the whole of what had been called the Saxon shore was in the hands of the invaders. The Angles now proved the most active, energetic, and terrible enemies of the Britons; they seized on and occupied Lincolnshire, and established themselves on the Wolds of Yorkshire and in the valley of the Swale. They thrust farther north, and at the beginning of the sixth century established themselves on the Tweed. In 547 Ida set up the kingdom of Bernicia, and placed his stronghold at Bamborough. In 550 the Mid-Angles

attacked and destroyed Ratæ, now called Leicester, and began to spread and establish themselves in the Midlands.

In the meantime Saxons had arrived in Southampton Water and conquered the open country, of which Venta, the present Winchester, was the capital. But the enemy were not invariably successful; a victory at Mount Badon, the present Badbury, in 520 revived the spirits of the Britons. In 530 the Isle of Wight was occupied by the Jutes. The West Saxons, staggered for a while by their defeat at Mount Badon, resumed the offensive, and in 556, by the victory of Barbury, made themselves masters of Wiltshire. Turning east they now advanced upon Verulamium and London, and reduced both about the middle of the sixth century.

It was not till 577 that the West Saxons set their faces to the setting sun and menaced the flourishing and opulent cities of Gloucester, Bath, and Cirencester. The overthrow of Deorham in the same year was the most tragic in the early history of our land, for not only did it entail the loss of these three important towns and centres of civilisation, but it broke the continuity of the line of defence of the Britons, and isolated those of Wales from their brethren in Devon and Cornwall.

This miserable defeat was the most fatal the Britons had endured, and thenceforth their power of resistance was enormously weakened. It marked, moreover, a stage in the conquest.

Hitherto the Angles, Saxons, and Jutes had been little better than a horde of Iroquois, murdering, plundering, destroying. Without any appreciation of art, culture, any of the refinements of life, like wild beasts, they had ravaged the land, finding pleasure only in destruction. From 577 they began to consider whether it were not as well to

attempt construction. They settled and established homesteads

At this point we may pause to inquire whether the entire population disappeared before their swords, as did every city and sign of a nobler and better life.

Both Freeman and Green believe that it was so. The latter says of the conquest, that it was an effacement of the Briton from the soil. Such as were not slain were driven to flight. The conquest "of France by the Franks, or that of Italy by the Lombards, proved little more than a forcible settlement of the one or the other among tributary subjects, who were destined in a long course of ages to absorb their conquerors. French is the tongue, not of the Frank, but of the Gaul whom he overcame, and the fair hair of the Lombard is all but unknown in Lombardy. But almost to the close of the sixth century the English conquest of Britain was a sheer dispossession of the conquered people, and so far as the English sword in these earlier days reached, Britain became England, a land, that is, not of Britons, but of Englishmen" ¹

This is, I venture to think, an over-statement. It is true that everywhere with ruthless savagery the Teutonic invaders destroyed all with which they came in contact that proclaimed a higher civilisation, in Yorkshire, as in Sussex and in Hampshire, everywhere the old towns were burned and left as heaps of ruin, and the invader refused to live in houses of stone, and within walls. That he was everywhere ferocious in his cruelty is also true, but that he was so blind to his interests as to slaughter or drive off men who, as serfs, might till the soil for him, and so insensible to beauty as not to become enthralled by the charms of the British damsels, that cannot be believed. What did take place was that all the chiefs and nobles, all those

¹ Green, "The Making of England," ed of 1897, 1 154

owning lands and exercising authority, withdrew before the invader, but not without desperate resistance ; and that the serfs and the women of a captured camp became a prey — the former continued as thralls under the new masters, and the latter remained as concubines and wives. If we may judge by the analogy of the Norman and Angevin conquest of Wales, then the invaders would have found allies among dissatisfied and envious British princes, who would side with the common foe to wreak vengeance on another Celtic chief for some petty slight, or to gain some poor advantage, and this would lead to closer ties and fusion of blood. And that at the very time when the Saxon invasion took place the Britons were torn by internecine feud, is matter of history.

It is not easy to explain the persistence of Celtic names of rivers, mountains, and valleys in any other way than by assuming that there remained on the soil a certain proportion of the older inhabitants. The physical features retain their Welsh designations ; it is the settlements of the new-comers that bear German names.¹

But in a sense, what Mr. Green and Mr. Freeman assert as to the complete expulsion of the Britons may be true. The Brythons, who had overrun Britain, were the conquerors, and remained as lords and princes ; whereas the Goidel, with a deep, dark tincture of Silurian blood, was still on the land, but as a serf. As a serf he remained under changed masters, and it is this that accounts for the patches of dusky skin, the dark hair and eyes, that are found in various parts of England.

Although the invader conquered everywhere, he found the conquest difficult. Every foot was contested, and that stubbornly. "It is this indeed which, above all, distinguished

¹ The very names of the Northumbrian kingdoms of Bernicia and Deira are British Brynaich highland ; and Deyft, lowland.

the conquest of Britain from that of the other provinces of Rome. In all the world-wide struggles between Rome and the Germanic races no land was so stubbornly fought for and so hardly won. In Gaul the Frank and the Visigoth met little native resistance save from the peasants of Brittany and Auvergne. No popular revolt broke out against the rule of Odoacer or Theodoric in Italy. But in Britain the invader was met by a courage and tenacity almost equal to his own. So far as we can follow the meagre record of the conquerors, or track their advance by the dykes and ruins it left behind it, every inch of ground seems to have been fought for. Field by field, town by town, forest by forest, the land was won; and as each bit of ground was torn away from its defenders, the beaten men sullenly drew back from it to fight as stubbornly for the next."¹

Before the advance of the barbarian Christianity disappeared Churches were burned, priests butchered. And yet sacred sites were still cherished. The church of Faulk-bourn, in Essex, would not be dedicated to S. Germanus of Auxerre unless it had been so before the Saxon invasion, and the recollection had hung about the charred runs till Essex became Christian again

In 580 the invaders had formed the Bernician kingdom, that occupied from the Firth of Forth to the Teviot, the range in which rises the Tweed, and the present counties of Northumberland and Durham. To the west was the British realm of Strathclyde. South of the Tees to the Humber was the Angle kingdom of Deira, reaching only so far west as to where the land begins to rise. There, in what is now the most intelligent, industrious, and densely peopled portion of Yorkshire, the West Riding, was the British kingdom of Elmet, and west of the Pennine Chan

¹ Green, *op cit* 1 p 142 Compare Nicholas "The Pedigree of the English People," 5th ed 1878.

was the British Cumbria, that comprised not Cumberland and Westmorland only, but also Rheged, or Lancashire. The West Saxons had indeed reached the Severn, but from the Parret to the Frome the entire western peninsula was in the hands of the West Welsh.

Happily these cut-throats, having mastered a half of Britain, now fell on each other. Each of the great kingdoms of Kent, Northumbria, Mercia, and Wessex in turn sought to become paramount, and each for a while succeeded. The invaders were actuated by a blind instinct. They strove after unity, and that unity could only be effected by the subjugation of the rival kingdoms. In their strife with one another the assistance of the Briton was called in. Thenceforth there was no extermination of the native. At the worst he was dispossessed of his lands, and turned from a chief into a tenant. It is probable enough that in our easternmost counties, as Sussex or Essex, in Norfolk and Suffolk, there may be but the smallest element of British blood present, perhaps hardly any; but this is certainly not the case with the Midlands, it is not in any degree that of the west of England, where the British race remains, from Cumberland to Devonshire, with only an infiltration of Saxon and Angle blood.

In 583 the West Saxon Ceawlin advanced up the Severn valley and utterly destroyed Uriconium (Wroxeter) under the Wrekin. He happily met at Faddley with such a severe check, that he was forced to retrace his steps. Faddley is near Nantwich. Although Ceawlin had ravaged, burnt, and murdered in his course up the Severn valley, he did not settle, and any Saxons left behind would assuredly have met with scant mercy at the hands of the outraged inhabitants of a once smiling basin, turned by the barbarians into a scene of devastation.

One of the most beautiful of ancient Welsh poems is the

lament of Llywarch Hên over the death of Cyndylan, son of Cyndruyn, the prince who fell at Uriconium, the White City.

“ Cyndylan's Hall is not pleasant to-night
On the top of Carreg Hytwyth (Shrewsbury Castle),
Without lord, without company, without feast !

Cyndylan's Hall is gloomy to-night
Without fire, without songs,—
Tears are the trouble of my cheeks !

Cyndylan's Hall pierces me through to see it,
Without roof, without fire—
Dead is my chief,—myself alive ! ”

We cannot sufficiently realise that the Anglo-Saxon invasion was everywhere the crushing out of a civilisation vastly ahead of their own, to replace it by utter barbarism. After the retreat of Ceawlin in 584 he remained inert till 591, when his nephew, Ceol, assisted by the Britons, met and defeated him in a great battle at Wanborough, near Swindon, and Ceawlin was obliged to fly, and two years later died in exile.

After such a defeat Wessex remained in a state of weakness and prostration, from which it did not recover till, in 643, Cenwalch became king. He resumed the conflict against the West Welsh, and in 658 drove them across the Parret.

In 688 the redoubted Ina was king, and in 710 he attacked the kingdom of Dyfnant, and planted Taunton as a border fortress against the Britons of the West.

After the battle of Deorham in 577, and the fall of Bath, Gloucester, and Cirencester, the enemy had occupied the Somerset low lands as far as the Mendip Hills and the marshes of the Axe below Weston-super-Mare, but a long spit of land, some fifty miles in length, had remained in the hands of the Britons. It extended to Cricklade, and

was protected on the west by a branch of the Wansdyke, that stretched from Malmesbury to the Mendips. Their tongue of country was not very wide; it reached to the Selwood Forest, to Devizes, and Calne. The population here was entirely British, but this was now brought into subjection. The difference in the manner of conquest at this period is seen in the way in which Ina treated Glastonbury. This had been founded in 601 by a British king, and when Ina occupied it he re-endowed the shrine, and allowed it to continue as a sacred centre to English and Britons alike.

We must now consider shortly the new factor of Christianity that had appeared to mitigate the savagery of the Anglo-Saxon, and to give to his conquests a character less one of extermination than that it had previously worn. The whole of Northumbria, and indeed Mercia as well, received the Gospel from the Celtic Church, through missions from Iona, itself a station of the Irish Church, which had Christianised both Scots and Picts. In 635 S. Aidan fixed his bishop's stool or see in the island-peninsula of Lindisfarne, on the Northumbrian coast, and with the assistance of Oswald, the king, converted Bernicia and Deira. When Aidan died in 651 his mantle fell on S. Cuthbert. The only portion of England that acknowledged the Roman obedience were Kent, East Anglia, and Wessex; but in 664, by the Synod of Whitby, the Northumbrian and Mid-Saxon Churches were brought into conformity with Roman usages; and Archbishop Theodore by his progress through the land between 669 and 677 brought the entire Anglo-Saxon Church to acknowledge the supremacy of Canterbury.

It was not possible for the Northumbrians, owing their Christianity to the Celtic clergy, to behave ruthlessly to the Britons professing the faith they had received, and

although in battle there was much slaughter, there were no further massacres of the population, supposing these had been, in the way assumed

About 620 Edwin of Northumbria crushed the British kingdom of Elmet, of which perhaps Leeds was the chief city, and advanced to the sea at Chester, whence he sailed to subdue Anglesey and Man. But against Edwin, Penda, king of the Mercians, rose to wrest from him the overlordship of Wessex and East Anglia. Assisted by Cadwallon, king of the Britons, Edwin was defeated and slain in the battle of Hatfield, 633

It was not till the second half of the eighth century that Devon was conquered, but not completely subjugated, for in 813 Egbert was engaged in hard fighting, and, as the Anglo-Saxon chronicle says, "he laid waste West Wales from eastward to westward." In 823 a decisive battle was fought at Gavulford (now probably Galford), a place on the Roman road from Exeter into Cornwall, where the hills close in to nip the road between them; the place along the whole line which is the most suitable for defence. Extensive earthworks mark the site, in the parish of Bridestowe. In 835 some Danish vessels entered the Tamar, and the Britons, uniting with them, attempted to recover the lands overrun by the West Saxons. Egbert collected an army, and a battle was fought at Hengesdon, on the Cornish side of the Tamar, in which the allies were routed. The last relics of the independence of the Domnonian kingdom disappeared after Athelstan's visits to West Wales in 926 and 928. On the former expedition he reduced the king, Howel, to submission, and on the next he expelled the British from Exeter.

In the meantime the northern Welsh had been pressed back into their mountains, the kingdom of Powys was reduced, and the prince was constrained to abandon

Pengwern (Shrewsbury) and set up his castle at Mathrafal. At the close of the eighth century Offa, king of the Mercians, threw up his dyke from the Dee to the Wye to restrain the Welsh.

We must now look at Wales itself, and see what had been its condition from the fifth century.

The original population had been Silurian, probably throughout the whole country, but the Ordovices, a British tribe, had pierced it, and had reached the sea in Cardigan, and thence had sent colonies into Ireland. To a considerable extent the Silurian aborigines had become fused with the Goidels. This became more pronounced as the Irish Picts invaded both north and south. These latter became masters of Gwynedd and of the Pembrokeshire peninsula. They struck farther inland and occupied Brecknockshire.

At the beginning of the fifth century Cunedda Wledig, chief of a body of Norsemen defending the Roman wall, either because driven south by the incursions of the Picts, or invoked by the Britons of Wales, sent a force under the command of his sons to free North Wales from the Irish Goidels who oppressed it. Thus they succeeded in doing, and thereupon settled themselves in the lands they had freed, and carved it into principalities for themselves.

But the Cunedda family not only founded the reigning house, but also furnished the Church with numerous saints. In the sixth century Maelgwn, a descendant of Cunedda, gained supreme power not only over Wales, but also Strathclyde. A century later another accession of saints came from the same district, the descendants of Coel Godebog, who settled in Wales and spread over it as evangelists and apostles. They seem at first to have planted themselves in Ergyng or Archenfeld, but thence moved to Anglesey and Bangor.

From Southern Wales the Irish Goidels were not dis-

lodged. In Brecknockshire the Irish Brychan was able to justify his holding of the sovereignty on the plea of descent from the ancient Welsh princes through his mother. He died about 450, and from him issued a mighty family of saints. He, or some of his family, must as well have established themselves in Cornwall, for we find there also a number of saints belonging to the same stock

Clydwyn, son of Brychan, is reported to have established his sovereignty over Menevia.

Somewhat later we find Cynyr of Caer Gawch, a petty chief in Menevia, of British ancestry probably, married to Anna, daughter of Vortimer. An illicit connection of his daughter with a son of the house of Cunedda led to the birth of S. David, and to the establishment of another saintly tribe.

The connection between Britain and Armorica had been uninterrupted from an early age. In 316, as we have seen, Cynan Meiriadog had led his army of picked men from Wales, and had established himself in Brittany¹

The advance of the Saxons, and the rolling back of the Britons, caused great numbers to fly to Armorica, and this immigration continued with few interruptions for two centuries.

The whole of the Breton peninsula, once occupied by the Coriosolites and Osismi, had been so ravaged by Frisians, and so exhausted previously by fiscal exactions and the revolt of the Bagaudæ, that it was almost denuded of population. About Vannes the original Gaulish population remained, as about Nantes and Rennes. The

¹ The Breton historians throw doubt on Cynan Meiriadog, and assert that he landed at the mouth of the Rhine, and settled there. Undoubtedly there was a British colony there, but the Welsh genealogies are very precise concerning Cynan having settled in what is now called Brittany. There are no Breton records of anything like the date of Cynan. Armorica included the whole north coast of Gaul from the Morini westward.

districts of Nantes and Rennes had been subjected to the Franks, and Vannes owned a loose submission. Procopius says that in the sixth century swarms of colonists from Britain, men with their wives and children, came into Armorica, "the most desert country of all Gaul." These migrations assumed large dimensions in 450, 512-14, and between 561 and 566.

The author of the *Life of S. Winwaloe* says, "The sons of the Britons crossing the British sea landed on these shores at the period when the barbarian Saxons conquered the isle. These children of a loved race established themselves in this country, happy to find repose after so many griefs. In the meanwhile, the unfortunate Britons who had not quitted their country were decimated by plague. Their corpses lay without sepulture. The major portion of the isle was depopulated. Then a small number of men who had with difficulty escaped the sword of the invaders abandoned their native land to seek refuge, some among the Scots, though enemies, the rest in Belgica." Ermold Nigellus, circ. 834, in a poem addressed to Louis the Pious, says, that when they arrived they were received by the Gauls in friendly fashion, because they were Christians.

Eginhard, who wrote at the beginning of the ninth century, says also, "When Britain was invaded by the Angles and Saxons, a large portion of the inhabitants, crossing the sea, occupied the districts of the Veneti and Coriosolitæ, at the extreme limit of Gaul."

There would seem to have been three main colonies. One occupied the north coast of what is now the department of Finisterre, and this was called Lyoness or Leon. Another and larger colony took possession of the land from Morlaix to the little river Couesnon, which now divides Ille-et-Villaine from La Manche. All this dis-

tract they called Domnonia. A third swarm took root in the land south of the Monts Noires, from the Brest roads to the mouth of the Ellé, on which is Quimper, and extending back to the river Oust. This was Cornouaille. In process of time these British settlers got a considerable footing in the territory of Vannes, so that the bishop Regalis complained to the Frank king, Guntram, that he was shut in by the Britons, and held by them as a prisoner.¹

The districts of Nantes, Rennes, and Retz were not British, and only by degrees did Vannes fall under their domination, the city last of all.

The diocese of Vannes was not founded before the latter part of the fifth century. It was not till the Council of Tours in 465 that S. Paternus was appointed to plant a church in Vannes, and he was obliged to fly and abandon the attempt. He died shortly after, away from his recalcitrant flock, among the Franks. Modestus, his successor, who attended the Council of Orleans in 511, did what he could to advance Christianity among the Veneti, but as the author of the Life of S. Melanius tells us, the people at the time were almost all pagans. The diocese of Rennes was not founded till 439, and there the people were hardly at all converted till the time of S. Melanius, Counsellor of Clovis in 511, who not only brought his own diocese to nominal Christianity, but also did something towards converting the Veneti. Such being the case, there can be no question but that the rest of Armorica was pagan, and that it owed its Christianity solely to the British immigrants, who brought with them their bishops and monks, their liturgy and their religious peculiarities. Armorica was in nothing indebted to the Frank Church, and we can quite understand the surprise

¹ Greg. Turon. x. 20.

with which the Breton Church heard of the claims of Tours to supremacy over it. In the dioceses of Nantes and Rennes the churches are dedicated to saints of the Roman kalendar, to Gallo-Roman heroes of the faith, SS. Clarus, Donatianus, Hilary, Similian, Rogatian, Julian, Martin, and the like. But the moment the ancient frontier into Brittany is passed, with the exception of such churches as are of later dedication to saints known through the Gospels and Acts, all are British, common to Wales and Cornwall, or of British ancestry—Paulus Aurehanus, Gildas, Samson, Broock, Gerrans, Suhen, Teilo, Oudoc, &c. A well qualified writer, M. de Courson, librarian of the Louvre, says: "I have had under my eye a very exact list of the ancient parishes of Brittany, with the names of their native saints, drawn up by the late Count de Blois de la Calande. Now, all the names, with the sole exception of that of S. Eligius, who had become popular through his relations with S. Judicael—all the names, I say, belong to British saints."¹

Unhappily, in their newly acquired lands, as in the old, the Britons could not combine. They were engaged in internecine strife till Nominoe, in the middle of the ninth century, not only formed of the confederacy a powerful kingdom, but extended the limits of Brittany to include Nantes, Rennes, and Retz, and the Duchy retained these acquisitions till the Revolution of 1789.

It may well be understood that the new settlers brought with them their clergy and monks, their native tribal organisation and religious customs, and that they entirely rejected the claim pertinaciously made by the Archbishop of Tours to have jurisdiction over Brittany.

But if I am not much mistaken, the colonies of Lyonesse, of Domnonia, and of Cornouaille in Armorica, remained

¹ "De Courson *La Bretagne du 5^e au 12^e Siècle*," Paris, 1863, p. 169

for a while under the native princes of Dyfnant. There was incessant drift to and fro Arthur is represented as having visited these settlements, and as having committed the government during his absence to his cousin Hoel. This was probably the Hoel Mawr of Breton legend, in 537 king of Domnonia.

This Hoel the Great was the Rival of the legend of S. Melor; he was married to Alma Pompæa, daughter of Budic, king of Cornouaille. He it was who murdered Melyan, his brother-in-law, and his nephew, Melor Rival is Rhi-Hywel, or Hoel the Lord or Prince. It was probably owing to his usurpation that Tewdrig, the other son of Budic, remained in his principality of Cornwall, where he fell on and killed some of the Irish colonists who came to settle in Pengwaeth, the Land's End district, and has left his trace in legend as a persecutor of the saints.

It was due to the violence of Hoel the Great that his brothers, Amwn Ddu, father of S. Samson and S. Tathan, Pedredin, father of S. Padarn, Gwyndaf Hen, father of S. Mewgan and S. Malo, and Umbrafel, father of S. Maglorius, fled for their lives and took refuge in Wales about 537.

In 545 Hoel died, and was succeeded by his son, Hoel Vychan, or the Little, when again a dynastic convulsion occurred. His brother, Canao, murdered him, and would have killed his other brother, Machau, had not the latter hidden himself and then escaped to Vannes. This was in 547 or thereabouts, and Canao maintained his position as Prince of Breton Cornouaille till 555, when Judual, son of the murdered Hoel, backed by Childebert, and supported by his cousin, S. Samson, at the head of levies of immigrants and discontented Bretons, defeated Canao and killed him. Samson and Judual had, in fact, headed another migration of British. These were fugitives from the West Saxons after the battle of Barbury Hill and the

occupation of Berkshire and the Thames valley. Some of these settled in Léon. The lead was taken by chiefs from Gwent. Macliau, who was Bishop of Vannes, seized on the opportunity to drive away Tewdríc, his nephew, the youthful son of Budic II., king of Cornouaille, and possess himself of his inheritance, which he retained till Tewdríc was old enough and strong enough to return, stir up an insurrection, and kill the bishop and one of his sons, and recover Cornouaille.

It will be seen that through the constant intercourse between Brittany, Cornwall, and Wales most of the saints of the former, down to the seventh century, are intimately associated with the two latter. Cornwall and Wales were the natural places of refuge of the princes of each generation at the periodical outburst of fratricidal ambition on the death of each prince. And when S. Samson and S. Padarn, and S. Winwaloe, and other saints of Armorican origin established settlements in Cornwall, it was not only for a pious motive, but so as to be near at hand when the opportunity offered to make a rush for the mainland to recover their inheritances, and in the event of being worsted, of having an asylum in which to take refuge.¹

Having thus sketched the history of the Britons from the Roman conquest, and having indicated, as far as is known, the ethnology of the population, we will turn back to follow the fortunes of the Christian Church among the Celts of Britain.

There can hardly be a doubt that the Church received her organisation, her orders, and her liturgy from Gaul, and not directly from Rome.

The Gallic liturgies, supposed by many to have had an Ephesine origin, and to have come through Lyons and

¹ Owing to the importance of the early history of Brittany and to the great difficulty in elucidating it, I have appended a summary as a separate article.

Arles, with far greater probability derive from Milan, the original liturgy of which was largely Oriental, and against the authority and diffusion of which Rome had at one time to fight even to maintain its own.

A curious story was introduced into the revised lists of the Roman pontiffs to the effect that Lucius, a British king, had sent to Pope Eleutherius for missionaries to instruct his people in the faith. There is nothing improbable in such an appeal, when the Britons looked to Rome for her cohorts to defend them and for articles of luxury; but the evidence is suspicious. It is not to be found in the earliest list, and was foisted in at a later period, apparently with deliberate purpose to give to Rome a claim over the independent Church in Britain, as her spiritual mother.

The external framework of the Empire formed the die into which was run the Christian Church as it left the hands of the Apostles, and it took shape and hardened into a diocesan system corresponding to the political organisation of the Empire.

Among the semi-Romanised Britons, no doubt to some extent this system had prevailed, but only to a very limited degree. The Romans do not seem to have interfered more than was needful with the national organisation, which was tribal. They left the land in the hands of the tribes, to be divided as was customary among them, and to be under their several chiefs, caring only to exact from them homage and tribute. When the Christian Church was established in Britain there were doubtless bishops in the several cities, such as London, York, and Caerleon, also perhaps at Carlisle. But to what extent they exercised jurisdiction over dioceses we do not know. The territorial system was strange to the Celt, and if the bishops were Britons, as is probable, they also almost certainly exercised an ill-defined authority.

In Africa, in Asia Minor, and in Italy, every town had its bishop, and such bishops held spiritual jurisdiction over the district that was under the civil governor residing in the town. The two jurisdictions were conterminous.

But a different state of affairs prevailed among the Celts. Their organisation was not territorial, but tribal. Each tribe indeed occupied a district, and it was under a chief. It was governed by a council of its householders, but in war was subject to the absolute rule of its chief. The government was at once democratic and monarchical. Land was held by the tribe, and was distributed among the members by the chief, aided by the council, and was re-parcelled as occasion arose. In return for the land, the clansmen owed him allegiance and military service. Each clan constituted an integral whole, and was independent of every other clan; and although several might be allied in customs, blood, and language, yet they acknowledged no bond. This was the great defect in the entire system. There was no nation, only an assemblage of tribes, each independent of the other, cohering temporarily, and the cohesion dissolved by the merest trifle. All peoples pass through certain stages of social and political growth, and after having made mistakes, rectify them and develop their innate greatness and characteristic virtues. But the Briton was not given the chance. His political education was arrested by the Roman conquest. It was again retarded by the Saxon invasion.

The tribe followed the chief as a swarm follows a queen bee. An individual not belonging to it was treated as an alien, who might be robbed and murdered with impunity. A member of another tribe was necessarily a stranger and an enemy.

When the number of heads of families in a clan increased to such an extent that the chief could no longer find them

lands, there remained no resource but migration or war against a neighbour; but the obligation on the chief to supply land ceased after the lapse of a certain number of generations. Then a swarm went off, conquered for itself a new home, and settled till it also outgrew its bounds. The practical result of this system was twofold. In the first place, it destroyed independence in the individual, who considered it his due to be furnished with lands by his chief, and in the second place, it produced chronic war among the tribes, and prevented united action against a common foe.

The law of gavelkind prevailed. Every princeling, if he had a dozen sons, on his death, left his authority and his command over land to be parcelled out and subdivided into twelve. Consequently rivalries, jealousies, internecine quarrels prevailed, and were made use of by the common enemy, and the folly of infinitesimal subdivision was not perceived till too late.

When Christianity appeared among the Celts, who did not live in the towns, and had not been citizenised and divested of their native character, it was compelled to assume an attitude and to adopt methods consonant with the Celtic constitution. The only possible mode in which it could make way was by winning the consent of the chief of the clan. No tribesman could profess Christianity without the permission of his chief, whom he was bound to obey in religious matters as in military. Consequently the first missionaries at once applied to the chiefs of the tribes, and if they did not convert them, they induced them to surrender to them a patch of land on which to settle. The inducement was fear. The chieftains feared the new medicine-men, and trembled lest their curses should prove more efficacious than the blessings of the Druids. The princes conciliated these new sorcerers with grants of land, in the hope that their incantations, in consort with those

of the Druids, would render themselves invulnerable in a fray, and the tribe victorious in all its aggressions.

When the missionary had obtained a plot of land, he threw up an embankment enclosing a circular or oval space, and planted a stockade on top. Within he erected huts : if among Brythons, of wood and wattle ; if among Goidels, of stone, circular, and these accommodated the population that accrued to him—slaves given by the chief, outlaws seeking refuge, bastards who had no claim on the tribal inheritance. Thus originated the Tribe of the Saint, a population subject to the missionary as chieftain, but also owing military service to the head of the secular tribe.

By slow degrees the Druids fell into disrepute, and their land and serfs were usurped by, or granted to, the saints. Thus it came about that side by side with the Tribe of the Land was to be found the Tribe of the Saint.

Moreover, the missionary settlements soon outgrew their bounds, and swarmed, as did the members of the Tribe of the Land, when not repeatedly thinned by war. Consequently we hear of the early saints wandering about in an apparently aimless manner, but always seeking to found fresh colonies, usurp lands that had been granted to the discredited medicine-men, found new churches, and extort fresh grants.

These saintly establishments were counterparts of such as were secular. They consisted of households comprising men and women, and they multiplied naturally. All the householders looked to the saint as their head, just as in the secular tribe all the members looked to and obeyed the chief.

But the members of the ecclesiastical tribe were not wholly independent of the head of the secular tribe ; they still owed to him military service, whether laymen or clergy.

Even in Ireland the women were not exempt. Doubtless the ecclesiastics were called out to curse the enemies of the chief, and if their curses proved ineffectual, they suffered deprivation

In Ireland it was not till 804 that monks and clergy were exempt from bearing arms against the foe of the chief, and then they by no means relished their release. Women were not relieved of their obligations to arm and fight in the ranks till the Synod of Drumceatt (A.D. 500), and then only on the urgency of S. Columba

Moreover, just as one secular tribe fought another, because of some quarrel between the chiefs, or because one wanted the lands of the other, or out of mere wantonness, so was it with the religious tribes. The monks regarded themselves as bound together into one tribe under an abbot, and they envied other monastic settlements. In 672 a battle was fought between the rival monasteries of Clonmacnois and Durrow, and Dermot Duff, leader of the men of Durrow, fell before the monks of Clonmacnois, together with two hundred of his followers. In 816 no less than four hundred men were slain in a battle between rival monasteries. In 700 the clergy of Ireland attended their synods sword in hand, and fought those who differed from them in opinion, leaving the ground strewn with corpses. S. Columba stirred up a fratricidal war between the men of the South and those of the North of the clan of Neill merely because he was not allowed to retain a copy of a book he had made, and this cost the Meath men no fewer than three thousand slain. If we may trust Gildas, British churchmen were not much better.

In time the chiefs themselves founded religious settlements and placed over them sons, sometimes in orders, sometimes not, so that ecclesiastical as well as political supremacy might be in their families

“In Ireland,” says Dr. Todd, “the land granted in fee to S. Patrick, or any other ecclesiastic, by its original owner, conveyed to the clerical society, of which it became the endowment, all the rights of a chieftain or head of a clan, and these rights, with the rights of the secular chieftains, descended in hereditary succession. The conarb, or co-arb, that is to say, the heir successor of the original saint who was the founder of the religious society, whether bishop or abbot, became the inheritor of his spiritual and official influence in religious matters. The descendants in blood, or founder’s kin, were inheritors of the temporal rights of property and chieftainship, although bound to exercise those rights in subjection or subordination to the ecclesiastical co-arb.”¹

At Iona, out of eleven immediate successors to S. Columba, there was but one who certainly did not belong to his family, and one other, of whose parentage we have no information. Phehm was bishop and chief of Cashel in the middle of the ninth century. In 850 he fell upon Armagh, slaying priests and bishop wherever he caught them. The kingdom of Munster was held by chiefs who combined the ecclesiastical with the secular power, and were bishops as well as princes. Armagh was a hereditary bishopric for eight generations to 1129. It is often asserted that these archbishops were lay intruders, but this is disputable. To hold the saintship and bequeath it to a son was quite in order, according to Celtic ideas. In Wales the same principle prevailed; bishoprics, canonries, and parochial benefices passed from father to son, or were retained in one family for generations. Where an ecclesiastic had, say, four sons, he divided the ecclesiastical inheritance among them, for each had a right to his share if born after his father had become bishop or

¹ Todd, “S. Patrick,” p. 149.

priest, but if he had been born earlier, then he had no claim on the ecclesiastical inheritance. Giraldus Cambrensis mentions one benefice that was held by two brothers, one a layman, the other in orders. Benefices in Wales and in parts of England with more than one rector, as, for instance, Tiverton, which had five till quite recently, owe their origin to this custom.

Should the tribe of the saint be without a head, and there was no one available in the family of the chief of the land to take the place of saint, or chief of the ecclesiastical tribe, then some one not of his blood was appointed to be the saint; but if so, he was required to give securities that he would resign his saintship as soon as there was one of the prince's family qualified to assume it.

How splendid and influential the position of the saint or head of an ecclesiastical settlement was, may be judged from the "Life of S. Cadoc." The author thus describes his power at Llancarvan. "He daily fed a hundred clergy and a hundred soldiers, and a hundred workmen and a hundred poor men, with the same number of widows. This was the number of his household, besides servants in attendance, and esquires and guests, whose number also was uncertain. Nor is it strange that he was a rich man and supported many, for he was abbot and prince"

When the chieftain of the land did not absorb also the chieftainship of the ecclesiastical tribe, then continual friction existed between the head of the land and the head of the Church; the former not only exacted military service from the members of the ecclesiastical establishment, but also an annual tax and contributions in kind. If the tax were not paid, he distrained and carried off the cattle of the saint, who had no other means of redress than to curse, and this he did freely. If any disaster followed, this was

at once attributed to the virtue of the curse, and on the whole, the spiritual heads got their own way. S. Beuno cursed a chief, and he dissolved into a puddle; S. Cadoc cursed his servant because he was clumsy in lighting a fire, and the flame leaped forth and consumed the man; some men who offended him had their beards and half the hair of their head removed, and the ears of their horses sliced off. Men on whom the curses of the saints fell were drowned, smothered in bogs, turned into stone, melted into lumps of wax, stricken with lightning. Even after S. Cadoc was dead, the corpse roared like a bull because the coffin was jostled.

The first stage in Ireland, Wales, and perhaps Scotland, was that indicated above, where the ecclesiastical tribe contained the professional believers, that is to say, the saint and those who owed to him tribal allegiance, that allegiance extending to the profession of his religion. In this stage the stockaded settlement contained men and women, households of those dependent on the saint, all working for him and for themselves, and paying a tribute in kind and service to the chief of the clan of the land. But when the faith spread and was universally professed, then the condition of affairs was altered. All the members of the clan could not pass into the saintly tribe, nor would the chieftain of the land tolerate the saintly tribe becoming too populous and powerful. A readjustment of arrangements took place. Either, as in Armagh, the chieftain constituted himself ecclesiastical head, and so resolved the double tribe into one under one head, temporal and spiritual at once, or else, and that more commonly, he withdrew from the tribe of the saint all its lay retainers, and the establishment resolved itself, or was compulsorily resolved into, a monastic society, comprising only clerics and monks, into which no women

were admitted, or the saintship was given to a daughter of the ruling house, with sisters and monks and bishops under her. When we read of the great monasteries of Bangor Iscoed, Bangor in Ireland, Llanancarvan, Llantwit, Clonmacnois, &c, with their thousands of monks, we hear of them in their second stage. Nevertheless, the hereditary principle remained in force, and the superior, the abbot, or saint was almost always of the family of the founder.

A peculiarity of this arrangement was that ecclesiastical jurisdiction was in the hands of the abbot or saint, who might be a layman, but who was very often not a bishop. Not only so, but where the headship was in the hands of a woman, she exercised jurisdiction over the entire district occupied by the tribe to which she belonged. In this case one, perhaps a dozen, in some cases a score, of bishops were members of the community, ranking just above the cellarer, exercising no jurisdiction, but kept in stock for the purpose of ordaining and consecrating in obedience to the orders of the abbot. The union of jurisdiction with the special grace of power to confer orders is a matter of ecclesiastical arrangement only, and in the Celtic Church did not exist, except perhaps among the Romanised Britons.

The term "saint" was applied at first very much as is the later term "religious" now. It signified no more than that the saint was the head of the religious tribe, and it may be, and probably was, applied indiscriminately to these heads, irrespective of their moral fitness for their position, or their conduct as ecclesiastical chiefs.

When the Bollandists began to compile the *Acta Sanctorum* they were vastly perplexed how to deal with the thousands of Celtic saints of whom they read. For instance, Bishop Gerald of Mayo was related to have ruled over 3300 saints—in this case saint meant no more

than monk. In the isle of Bardsey as many as 20,000 saints were said to have laid their bones. The Bollandists say. "The Irish would not have been so liberal in canonising dead men in troops whenever they seemed to be somewhat better than usual if they had adhered to the custom of the Universal Church, and given that honour to martyrs only."

But the Bollandist writer did not understand the case. It was not one of canonisation at all, but of alteration in the signification of a word. The Apostle spoke of the saints at Corinth and Ephesus, but some of these were exceedingly immoral persons. A "religious," as a Latin would term him, would by a Celt in those days be designated a "saint." In the second stage the term came to be limited to founders of settlements and churches. It may be remarked that only noble and princely families produced saints, for indeed none not well born could become head of an ecclesiastical tribe. At the same time, it is observable that a very discreditable origin is given to a good many Celtic saints, that was due to the fact of the headship of a religious settlement being given as a means of provision for a princely bastard.

If a woman of one tribe went astray with a member of another tribe, her child had no rights in her tribe, none in that of the father. But if that woman was, as in the case of the mothers of S. David and S. Kentigern, of a princely house, then their fathers or brothers found a means of providing for these illegitimates by making them saints. It has caused perplexity to account for the number of children attributed to some of the founders of saintly families. Brychan is given twenty-four sons and twenty-five daughters, in all forty-nine children, and of these half were saints. The explanation is that these saints were of the kin of Brychan, and so were appointed to monasteries

or ecclesiastical settlements that fell to his share by right of conquest. When a prince looked about him to settle his family he brought up so many to be warriors and the rest to be saints.

It has provoked some comment that nearly all the saints of the Welsh Church were foreigners, *i.e.* members of invading and conquering families. The three saintly families of Wales were respectively those of the Irish Brychan, conqueror of Brecknock, the Pict Cunedda, who invaded Wales from the north, and of the Northern Caw, who came from Albany. The fact was that these invaders turned out the native chieftains from their headship in the land and in the Church, and gave all places of authority to their own children and clansmen

To return once more to the separation that prevailed in the Celtic Church between jurisdiction and the episcopal office. A territorial distribution and jurisdiction over a see was given to bishops because the Roman civil organisation showed the way, but where, as in the Celtic world, there was a different sort of organisation, that which was tribal, with now shrinking then expanding confines, the Church had to accommodate herself to those conditions with that elasticity which belongs to her. In the Celtic world the tribe was the only constituted entity, and the land changed hands as the tribes fought and wrested soil from one another, not for ages were the boundaries fixed. But in the Roman world the districts were mapped out, and the people subjected to rulers over these districts, to whatever race or clan they might belong.

The ecclesiastical jurisdiction was first of all in the hands of the founder, a missionary saint, but then it passed by the principle of heredity to whoever represented him in blood, or to the nearest of kin to the chief of the land.

At Kildare, S. Bridget had bishops under her direc-

tion and orders. So had S. Ninnoch in Brittany. In Iona, S. Columba in priest's orders ruled over Bishop Etchen.

There was no parochial system; there could be none when the land was parcelled up and distributed among different members of the tribe every few years. The ecclesiastical *foci* were the settlements of the saints. These were permanent, for the land about them was in the permanent possession of the saint for the time being. When a member of a religious establishment became restless or restive he went off, taking with him some like-minded saints, and established a new settlement.

When the Saxons, Angles, and Jutes first invaded Britain they almost exterminated the British people; those whom they did not enslave they drove back to North and West. Apparently the Church of Romano-British had been hitherto fully occupied with the conversion of the peoples of the same race elsewhere. If we hold that S. Patrick came from Strathclyde, then the conversion of Ireland was due to it; certainly so also was that of the Goidelic peoples in the North and West. After Ireland was brought to the faith by Patrick it relapsed, and its reconversion was due to Welsh missions. Hosts of saintly evangelists, moreover, sallied forth from Ireland a little later and overran Western Europe, England, Scotland, Brittany, France, Alsatia, Lorraine, and penetrating into Bavaria, Rhætia, Helvetia, Germany, and even Italy, founded settlements after the native type. All that part of the British Isle now called Scotland owed its Christianity to the mission of Columba from Ireland; so did the great Northumbrian Church, where the invaders of German blood were brought to the worship of Christ through the missions from Iona. Wales, Cornwall, were Christian long before Augustine was born. "By armies of monastic mission-

aries," says Mr Haddan, "and next by learned teachers—first attracting pupils to Irish schools from all Christian Europe north of the Alps and the Pyrenees, and next, by sending forth men to become the founders of schools, or monasteries, or churches abroad—the churches of St Patrick and S Columba stand out, from the sixth century forward, as the most energetic centres of religious life and knowledge in Europe; the main restorers of Christianity in paganised England and Roman Germany, the reformers and main founders of monastic life in Northern France; the opponents of Arianism, even in Italy itself, the originators in the West of the well-meant, however mistaken, system of the Penitentials, the leading preservers in the eighth and ninth centuries of theological and classic culture, Greek as well as Latin, the scribes, both at home and abroad, of many a Bible text; the teachers of psalmody, the schoolmasters of the great monastic schools; the parents, in great part, as well as the forerunners, of Anglo-Saxon learning and missionary zeal, the senders forth of not the least bright stars among the galaxy of talent gathered by Charlemagne from all quarters to instruct his degenerate Franks, . . . down to the very Normanising of the Celtic Churches in the entire British Isles in the eleventh and twelfth centuries" ¹

¹ Haddan "Remains," p 260 I subjoin an incomplete list of the monasteries or centres of mission work founded by these Irish evangelists on the Continent —

In France Irish foundations —Remiremont, Lure, Besançon, Roman-Moutier, Bezere, Brezille, Cusance, S Uranne, Jouarre, Reul, Rebaix, Faremoutier, S. Maurles-Fossés, Lagny, Moutier la-Celle, Hautvilliers, Moutier-en-Der, S Salaberga, Fontanelles, Jumièges, S Saens, Luxeuil, Anegray, Fontaines, Péronne, Toul, Amboise, Beaulieu, Strasburg

In Brittany Welsh foundations —Dol, Rhys, S Briec, Landewennec, Trecor, Alerh, Plaz, Baulon, Penpont, Suliac, Pentual, Castel Paul, &c

In the Netherlands —Namur, Waulsort, Liège, Gueldres, Hautmont, Soignes, Malnes

In Germany and Switzerland —Hohenau, Erfurt, Effenheim, Schuttern, Wurzburg, Memmingen, Mainz, Cologne, Ratisbon, Constance, Reichenau, S Gall, Bregenz, Rheinau, Dissents, Seckingen

In Italy —Bobbio, Taranto, Lucca, Faenza, and Fiesole

Maccald, a native of Down, became Bishop of Man in the fifth century, S Donan was the apostle of Uig, S. Maelrubb, of Skye. In fact, the Christianising of the whole of the north-west of Scotland and the adjacent isles was due to S. Columba. Irish monks pushed as far as the Faroe Isles and Iceland S. Brendan thrust his vessel towards the setting sun, seeking lands to conquer for Christ. S Ardan, the apostle of Northumbria, whose diocese extended from the Humber to the Firth of Forth, was an Irishman from Iona. Diuma, the first bishop of the Mercians, and his successor, Ceallach, were both Irishmen. S. Fursey, another, preached the Gospel in Suffolk. Mailduff established a mission centre among the West Saxons. S Bega laboured in Cumberland. From the beginning of the sixth century they overspread Europe, and Irishmen for their distinguished piety were elected to fill sees even in Italy.

The Celtic Church had other peculiarities beside that of dissociating jurisdiction from the episcopal office. It observed Easter on a different day from the Latin Church, but this was due to an error occasioned by its isolation, very similar to that in which the Eastern Church is now involved from the same cause—adhering to an antiquated system of calculation. In reckoning the date of Easter, every year, the Roman Church had followed the Jewish cycle of eighty-four years, while the Alexandrian Church used the metonic system of nineteen years. This led to great inconvenience, and in the year 387 some observed Easter on March 21st, others on April 18th, others again on April 25th. This became intolerable, and Pope Hilary employed Victorinus to frame a new cycle, which was thenceforth followed in the Latin Church. But the invasions of barbarians had cut off the Celtic Churches from communication with the rest of the Christian world,

so that they were ignorant of this change, and continued to follow the old Jewish cycle, as observed at Rome and in Gaul previous to the change, of which they had not heard.

Nothing could exceed the indignation and disgust of Augustine and his followers when they ascertained that the British Church observed Easter on a different day from themselves. Instead of inquiring into the cause, and dealing gently by argument with the bishops and abbots of Britain, they heaped on them epithets expressive of loathing, termed them Quartodecimans, which they were not—but an ugly name answered their purpose—and denounced them as schismatics and heretics.

This unhappy miscalculation about Easter proved a grievous cause of weakness in the Celtic Church, for those of her saints who travelled to Gaul or Italy were forced to admit that their native Church was in error, and returning home formed a party which laboured for the abandonment of the old computation.

Another peculiarity was the tonsure assumed by the clergy. Cutting the locks in a certain fashion was a symbol of belonging to a tribe, just as puncturing the ear marks a horse turned loose on downs as the property of certain owners.

An illustration occurs in the life of S. David. His missionary work was bitterly opposed by the Irish settler Boia, the remains of whose castle are still traceable half a mile below S. David's, on the Allun. But more hostile to the saint than the chief was his wife. In order to propitiate the gods and induce them to destroy the saint, this woman resolved on a sacrifice. The best and most efficacious that could be offered would be a child of her womb, but she had none. Therefore she called to her a daughter-in-law named Dunawel, retired with her into a

hazel grove, placed the girl's head on her lap that she might cut and braid her hair, such an act betokening adoption into the family. Then the woman with a sharp knife cut her throat, and offered the expiring life to the gods.

The peculiar shaving and shearing of the hair adopted by the Celtic clergy betokened their adoption into the family of God, the ecclesiastical tribe.

This peculiarity was also laid hold of by Augustine and his followers, and denounced in furious terms as the tonsure of Simon Magus, as the badge of perversity and diabolical heresy.

There were other differences, as that episcopal consecration was administered by a single bishop instead of by three, as decreed by the Council of Arles, but as Gregory the Great had told Augustine that in case of need he might dispense with coadjutors in the conferring of episcopal orders, this point would not have been pressed had not Augustine and the Latin missionaries gone out of their way to find occasion against the native Church. In fact, these points served as excuses for insulting and repudiating the Church of the Britons. Augustine was angry to find that he had been forestalled, and that there was an Apostolic and Catholic Church of at least three centuries' growth in the island, which he had entered figuring as its apostle. He might, indeed, have swallowed his spleen had he found the British bishops ready to cast themselves at his feet and become his humble henchmen. As they would not consent to this, he and his Latin clergy, and their successors, covered them with obloquy.

At the bottom of all the differences lay the independence of the Celtic Churches, which owed no allegiance to the Papal chair, had organised themselves, expanded, and evangelised, had manifested extraordinary vigour, and produced

great sanctity in their independence. There was a robustness and healthiness about their churches that the Latin missionaries did not relish. In episcopal constitution, derivation of orders from the Apostolic fountain-head, in unity of doctrine, in liturgical forms, the Celtic Churches were one with the Catholic Church throughout the world, whether Eastern or Western. They were ready to acknowledge a certain primacy in the Roman see, as S Columbanus said, later, "next to Jerusalem," but such a half admission would not satisfy those who were, before all things, missionaries to extend the Papal authority.

Every sort of false accusation, malignant insinuation, and open outrage was offered to the ancient British Church. Its orders were ignored, its ministrations flouted, the orthodoxy of its prelates disputed.

Those British Christians who visited Rome, or were for a while in Gaul, returned intensely Romanised, and threw in their lot with the anti-national party, much as some young clergy of the present day after a visit to the Continent return enamoured with some fantastic ceremony they have witnessed abroad and endeavour to thrust it on their reluctant congregations at home, and who maintain that what is done in Latin churches must be right.

The temper of mind in which the Celtic bishops and abbots regarded the Popes may be judged from the letters of S Columbanus. The position assumed by him towards the Pope substantially amounted to this. an acknowledgment of the Bishop of Rome as a true bishop of the Church of Christ, but as one having no jurisdiction over himself, and a claim to criticise freely, and from the independent standpoint of an equal, the character and conduct of the Roman pontiff.

The language which he addressed to Boniface IV. is not that of a subordinate to a sovereign in the Church, but is

couched in terms of great freedom. He laments over the infamy that attaches itself to the chair of S. Peter in consequence of the miserable squabbles that rage in Rome. He warns the prelate not to forfeit his dignity by perversity, for his power depends, says he, on his maintaining right judgment in all things, for that only such an one can be regarded as a holder of the keys of heaven who opens the doors to the good and shuts to the bad. He exhorts the Pope to cleanse his see from error, for it would be a lamentable thing for the Apostolic See to lapse from the Catholic faith. He upbraids the Roman Church for making exaggerated claims to authority and power other than what was possessed by other Churches, and he allows to the see of Rome a high position of honour, second only to that of Jerusalem.

If this were the general relation in which the British Churches stood to the Papal See, no wonder that Pope Vitalian, in 667, wrote to King Oswy to choose an archbishop for Canterbury who should root out the tares from the whole island, alluding thereby to the clergy of the National Church.

The peculiarity in the observance of Easter was abandoned by the Church in the south of Ireland in 634, by the Northumbrian Church in 664; the Britons of Strathclyde submitted in 668, the northern Scots in Ireland in 697; in 704 a Roman party was formed in Iona itself. The British of the eastern portion of the West Welsh in Devon and Cornwall accepted the Roman computation in 710. The change took place in Wales between 768 and 777. Llandewennec, in Brittany, retained the Celtic tonsure till 817.

There exists at Canterbury a copy of a letter written by Kenstec, or Kenstet, bishop-elect of the Cornish Britons, in which he professes his obedience to the see of Canter-

bury, then ruled by Ceolnoth, who was archbishop between 833 and 870

In 884 a Saxon see was constituted at Exeter, with jurisdiction given by Canterbury over Cornwall.

In 905 the Pope having complained to King Edward the Elder and to Plegmund, Archbishop of Canterbury, that the great see of Wessex had been vacant for seven years, Edward and Plegmund together divided the see into five. Winchester, Framsbury, Sherborne, Wells, and Crediton, and to Crediton were assigned three estates in Wales, *i.e.* Cornwall, to be under the authority of the Bishop of Devon, because hitherto the Cornish had been without awe of the West Saxons. The bishop was of course a Saxon, Eadulf. Moreover, an order was made that the bishop should pay an annual visit to Cornwall "to extirpate their errors, for formerly they resisted the truth, and did not obey the apostolical decrees," that is to say, they clung to their traditional observances and to the independence of their Church, all which was hateful in the eyes of such men as Plegmund. An interesting letter by Archbishop Dunstan has been recovered, in which he says that the Cornish had their own bishop, Conan (Cunan), and that he lived in the reign of Athelstan, 925-940. But under Edred, 945-955, there was another, Daniel, whose bishop's stool was at S. Germans. But Edgar bade Dunstan consecrate Wulfsige, a Saxon, whose signature remains in 980 and 988. The Cornish see seems to have been transferred from S. Germans to S. Petrocks (Bodmin) some time after Daniel's consecration, and was brought back in 981. The Cornish see of S. Germans was extinguished, and jurisdiction over the West Welsh was given to the Saxon bishop of Crediton, 1042, and was transferred to Exeter in 1050.

The method adopted by the Saxon kings, partly in their

own interest, partly in that of Rome, was to quell all religious as well as political independence in the Cornish, and this policy was pursued also by the Danish and Norman kings. The process followed was this *First*, the British bishops and clergy were subjected to a torrent of abuse as heretics and schismatics, till they yielded their peculiarities and adopted the correct Easter computation, the Latin tonsure, and territorial in place of tribal organisation in the Church. *Secondly*, Saxon bishops were intruded in place of native Cornish rulers. Then, *thirdly*, the episcopal throne was withdrawn from Cornwall wholly, and placed, first in Crediton, then in Exeter, away from all association with Celts, for, be it recalled, Athelstan had expelled the British from Exeter. And this was done with Papal approval, for it was the stifling of ecclesiastical independent life in the Celtic race in the Domnonian peninsula.

This will be more apparent when we give the list of bishops as far as is known —

- KENSTEC**, Bishop at Dinnurrin, in Cornwall, submitted to Canterbury, 833-870; a Briton
- EADULF**, Bishop (Saxon) at Crediton, was given three manors in Wales beyond the Tamar—a foothold among the pure Britons, 905.
- CONAN**, Bishop at S. Petrocks (Bodmin), 931-940; a Briton, but retained much about the court of Athelstan, and apparently more there than in Cornwall.
- DANIEL**, Bishop at S Germans, 945-955; probably a Briton.
- ATHELSTAN**, an intruded Saxon, 955-959.
- COMOERE**, Bishop at S. Germans, 959-966; probably a Briton.
- WULFSIGE**, an intruded Saxon, 966-988.
- EALDRED**, an intruded Saxon, 993-997.
- BURHWOLD**, an intruded Saxon, 1002-1020
- LYVING**, Saxon Bishop of Crediton, having already three manors in Cornwall, now obtained the abolition of an independent Cornish bishopric, and the subjection of the whole of Cornwall to the see of Crediton, 1026-1038
- LEOFRIC**, 1046-1071, had the see of Crediton, together with jurisdiction over Cornwall, removed to Exeter.

Not till 1877 was a bishop's stool restored to the West Welsh, with Truro as the cathedral, and not yet has a Cornishman been given the pastoral staff to hold spiritual rule over his brother Cornishmen

In Wales a somewhat similar process was pursued. Elbod, or Elfod, Bishop of Bangor, in 768 induced North Wales, and in 777 South Wales, to adopt the Roman Easter, and the process of transforming the organisation of the Church from one tribal into one that was in conformity with the Latin usage, proceeded gradually

It was possibly due to Armorican influence that the Welsh Church abandoned its peculiarities. As Mr Borlase happily puts it, "We can readily imagine that the natives would adopt changes from their brethren in Armorica, while the Saxons might strive in vain to force them upon them. The Briton was stubborn and unbending, and he is so to this day. He might be led, but he would never be driven. His errors, if they *were* errors (and this we may be quite sure he did not admit), would be dearer to him than an orthodoxy enforced by the conquerors, and thereafter to be worn by him as one of the badges of his vanquished race."¹

In 871, on the death of Einion, Bishop of Menevia, Hubert, a Saxon, was intruded upon the throne of S. David, and again a Lambert, consecrated by the Archbishop of Canterbury, in 874, unless, as Haddan and Stubbs suppose, Lambert and Hubert are identical, in which case the delay in consecration was probably due to the resistance of the clergy to having an alien forced on them. At the same time another Welsh see was filled with bishops consecrated at Canterbury, Llandaff, to which first Cymelliauc and then Lliliau were ordained

According to the book of Llandaff, some bishops of that see and also some of S. David's were consecrated by the

¹ "The Age of the Saints," Truro, 1893

Archbishops of Canterbury at the close of the tenth century, but the statements are in a condition of such hopeless inconsistency, that it is advisable to reject them.

In its struggle for independence the archiepiscopal see of S David's claimed its rights as derived from Jerusalem, and the story was invented that S David had been consecrated and given supremacy over the British Church by the Patriarch and successor of S. James of Jerusalem. By this assumption the see of S. David pitted S. James against S. Peter. But although it is possible that S David may have visited Jerusalem, it is not probable that he was there consecrated. It was not till the Norman conquest of Wales that the independence of the Welsh Church came to an end.

Let us look now for a moment at the Celtic Church in Brittany. This, as we have seen, was intimately related to that of Wales. S. Sampson, abbot and bishop-chieftain of Dol, was a man partly of Welsh, partly of Armorican descent, but of wholly Welsh education.

In Brittany there was no territorial Episcopacy; the bishop or abbot was head in ecclesiastical matters of the tribe or clan to which he belonged.

The trace of this remained till late in the different constitutions of the bishoprics which were purely British and those which were Gallo-Frank. In the former the prelates were sovereign chiefs within their episcopal cities, independent of the political chiefs, kings, and dukes. This was because the founders had been granted these lands on which to establish their ecclesiastical colonies, and they continued to enjoy the privilege, which was consonant with Celtic ideas.

When Latin ideas began to prevail, then the tribal property became territorial, both among lay chiefs and among ecclesiastical chiefs, and the diocesan organisation of Brittany began to assume shape.

In Brittany proper there were bishops at Aleth, Dol, León, Treguier, these in Domnonia. Cornouaille was ruled by a bishop, whose see was sometimes at Quimper Vannes belonged off and on to Brittany, and especially to Cornouaille, according as Breton or Frank influence prevailed. The Breton clergy and bishops were wholly independent of the Franco-Gallic Church; and the archdiocese of Tours could only assert a claim on the grounds of a pretended consecration of S Coentín by S Martin. Nantes and Rennes bowed before the crozier of Tours, but the other sees stubbornly refused allegiance.

In 846 a very able man, Nominoe, of whose origin we know little, succeeded in becoming duke and then king over all Brittany. He resolved on wresting his country from its loose allegiance to the Frank crown, and at the same time on putting an end to the claims advanced by the Archbishop of Tours to jurisdiction over the Armorican bishops. He constituted bishoprics at S Brieuc and S Rabutual, and revived that of Dol, and endeavoured to elevate Dol into an archiepiscopal see for all Brittany. By this he separated the Breton from the Frank Church, or to be more exact, maintained its independence, which it continued to assert for another three hundred years. All the attempts made by Popes Nicolas I., John XII and XIII, and Leo IX. to oblige the Archbishop of Dol to submit to the Latin Church and acknowledge the Archbishop of Tours were as ineffectual as were the previous denunciations of the Councils of Toul and Rheims in 859 and 1049. It was not till Gregory VII. occupied the throne that this schismatical or independent province could be reduced to obedience, and not till 1172 that the archbishopric of Dol submitted to become a suffragan see.

As early as 566, in a Council held at Tours, a canon had been launched against the Celtic clergy, forbidding

“the consecration of any bishops in Armonica, whether they be Britons or Romans (that is to say, Gauls), without the consent of the metropolitan or his co-provincials, under penalty of exclusion from the communion of the other bishops, till next Synod” This shows that in the sixth century the usage in Brittany was much as it was in Ireland, Wales, and Scotland, for bishops to be consecrated in large numbers, and regardless of their having any sees.

It was doubtless during the struggle to uphold the jurisdiction of Dol after 846 that the legend of Sampson of Dol having received the pall was invented.

We will now take a brief glance at Scotland

In North Britain the Saxon kingdom of Bernicia extended to the Firth of Forth, but the only settled bishoprics were those of Lindisfarne and Witherne, the latter of English foundation, and entirely antagonistic to Celtic peculiarities. Lindisfarne was captured for the Roman party by Wilfred from the Celtic Bishop Colman, and the monasteries were ravaged by the Northmen. Consequently the National Church in North Britain rapidly became one in complexion and character with the Latinized Church of Northumbria, and the only possible representatives of the earlier foundation were the *Culdees*, *Cultores Dei*, anchorites or solitaries, who kept up some of the peculiarities of the Celtic Church.

At Iona a schism had taken place in 704, and rival abbots co-existed there till 772, each at the head of a party of monks, one set observing the Celtic Easter, the other the Roman Paschal computation, and butting with their variously tonsured heads at each other in angry controversy. But on the death of the Abbot Suibhne the conformity of the whole monastery of Iona to the Latin rule was established. National customs, however, died hard. When S. Margaret, a Saxon princess, with ingrained Latin pro-

clivities, married King Malcolm III., in 1069, she supposed it was her mission to extinguish the last embers of independence in the Scottish Church. She laboured against four customs that still prevailed.—

1. The commencement of Lent on the first Monday in Lent instead of on Ash Wednesday—a custom that prevails at Milan to the present day.

2. The non-reception of the Eucharist on Easter Day. In this particular, Celtic custom has prevailed in the Latin Church, where at present the Easter communion is made on Maundy Thursday *instead* of on the Feast of the Resurrection.

3. Labour on the Lord's Day—a manifest abuse.

4. Strange, that is to say, Celtic, customs at Mass. In fact the old Celtic liturgies of Gallican origin, and belonging to the Ephesine or Milanese family, and not to the Roman, were in use still. S. Margaret's biographer informs us that "In some places among the Scots there were persons who, contrary to the custom of the whole Church, had been accustomed to celebrate Masses by some barbarous rite, which the Queen, kindled with God's zeal (!), so laboured to destroy and bring to naught, that thenceforth there appeared no one in the whole race of the Scots who dared to do such a thing."

It was due far more to her zeal in thus suppressing independent usages in the Church than to her real or supposed virtues, that she has obtained canonisation at Rome. What this "barbarous rite" was we shall see somewhat later.

But although S. Margaret may have secured open submission, she could not completely extinguish the lingering love of and adhesion to the traditions of the Fathers. Fifty years later, in the reign of King David, we learn from the Chronicle of the Picts and Scots that the Culdees, "in a

corner of their Church, which was very small, were wont to celebrate their own office after their own fashion."

This was the final spark, and it went out. In Scotland accordingly "the old Celtic Church came to an end, leaving no vestiges behind it, save here and there the roofless walls of what had once been a church, and the numerous old burying-grounds, to which the people still cling with tenacity, and where occasionally an ancient Celtic cross tells of its former state."¹—"Thus ended the struggle for independence, after it had continued for more than a century and a half. Wales, at the beginning, was the head of a great and powerful Celtic confederacy, at the end, it was almost alone. A party in Hy (Iona), and, perhaps, also the Breton clergy, remained faithful to the last to the cause of Celtic independence, but Wales had no other allies. The Church of Ireland had so entirely turned against it that by its canons it had put restrictions upon the ministrations of such clergy as came from Britain, and had condemned their churches for separating from the Roman customs and from the unity of Christendom. The prolongation of the struggle only completed the isolation of Wales; and though by its submission to Rome it again entered nominally into fellowship with the rest of Western Christendom, it was long separated in feeling from the English Church and the churches of the Continent, and it never quite regained the old connexion with its Celtic brethren. It had lost alike its headship and its colonies."²

But it lost more than this; it was by degrees deprived of its native vigour and independent genius; and although when the Norman conquest of Wales took place the clergy were all Welsh, yet the constitution had become stereotyped into the approved diocesan, territorial shape, and had ceased

¹ Skene, "Celtic Scotland," vol ii p 417

² Newell, "History of the Welsh Church," p 133

to be tribal. Moreover, the old Celtic monastic institutions, in which the religious activities of the British had been focused, had fallen into decay. Then came the Norman invasion under Robert Fitzhamon, 1091, and the subjugation of the south of Wales, which was speedily studded with strongholds, and the iron hand of the Norman thenceforth held the people down. On the death of Gruffri, Bishop of S. David's, the clergy elected Daniel, son of a former bishop, Sulen, to the vacant see; but King Henry I. put him aside "against the will and in contempt of all the scholars of the Britons," and thrust upon them Bernard, a Norman, not even at the time in priest's orders, who was required to make formal profession of canonical obedience to the see of Canterbury, in order to bring the Welsh Church completely under Norman and Roman control.

This is, perhaps, one of the grossest cases of royal interference with the canonical rights of the Church that is on record, at least in England. The prelate imposed on a diocese, unanimous in refusal, by the mere will of a king, was pitchforked into priestly and episcopal orders in one day.

Already in 1092, Hervey, a Norman, but of Breton parentage, had been forced on the see of Bangor, the see of S. Asaph had been subjected to the same violence; another Norman, Urban, had been imposed on Llandaff. Hervey maintained his position by force of arms only, actually fighting against the sheep of his pasture at the head of a band of soldiers. At last the outraged Cymry could endure this no longer; they rose and expelled him in 1107. Pope Pascal's sympathy was with him, regarding him as a martyr to the cause of Roman supremacy. He was consoled with the see of Ely.

Thenceforth every bishopric was filled with nominees of the Norman and Angevin kings, men who knew nothing of

the language and customs of the Welsh people, elections by the Chapters, if in favour of native candidates, were ignored or quashed; and the lands of the Church were ruthlessly torn away from the tribes whose clergy they had supported to enrich Norman and English abbeys. Thenceforth no Welshman was eligible for a see or an abbacy, even at last for a parochial cure. "The policy of the English Government was to degrade the Welsh, and not to encourage the ordination of any Welshman, as none were considered worthy of a place of trust. So arose an alien Church, supported by alien clergy, and not the least of the feelings of the Welsh against the Church was that a body of men who were supported by Wales, and who ought to be, before all things, Welsh, were all foreigners, and no Welshman could be legally admitted a member of the body. Orders were to the Welsh a closed door. . . . The clergy, though not Welsh, became more and more tolerant of the Welsh, and while in name Latin, with them local ideas largely prevailed. The Celtic customs still lived in spite of the fact that nominally they were superseded by the Latin"¹

One more effort to obtain a semblance of independence was made later, in 1198-1203. The Norman bishop, Peter de Leia, was dead, and the Chapter nominated for the royal sanction Gerald de Barri and three others. Gerald was grandson of Nest, daughter of Rhys, king of Deheubarth, the most beautiful woman of her age, and he inherited from her personal beauty and an intense love for Wales and the Welsh. Precisely for the reason that he was Welsh by birth and partly Welsh by lineage he was unacceptable to the King and the Archbishop of Canterbury. John, Richard being dead, refused to ratify the election of the Chapter, and Gerald appealed to Rome, but in vain; the King and Archbishop could bring more from their

¹ Bund, "The Celtic Church in Wales," p. 499

pockets in bribes than the Archdeacon of Brecon. For five years Gerald contested the matter, passing between Wales and Rome, and only abandoned the struggle when he found that his purse could no longer sustain it. When he yielded, from that day the see of S. David's was forced to bow under the supremacy of Canterbury. "Many and great wars," said the Prince of Powys, "have our Welshmen waged with England, but none so great and fierce as his who fought the King and the Archbishop, and withstood the might of the whole clergy and people of England, for the honour of Wales."

But, indeed, it was a hopeless struggle, for the Pope was as little likely to relish the independence of S. David's, as the King of England and the successor of S. Augustine at Canterbury.

Giraldus describes to us the sort of men who were sent to fatten on the ecclesiastical benefices of the Welsh. The Norman bishops forced on the reluctant Church came there, *pasci non pascere*, to stuff themselves, and not to pasture the flock. Amongst them was one who always promoted the most incapable among his relatives, alleging that the capable ones could get along without his aid, but the others would starve. He tells how a priest brought to his diocesan a hundred eggs, "ova," but by slip of the tongue said "oves," sheep, whereupon the prelate forced the man to be as good as his word and furnish him with a hundred sheep. And, indeed, the Norman and English clergy thrust into the parishes were not only ignorant of Welsh, but also of Latin. One preaching on S. Barnabas' Day, spoke of his virtue and repentance, and of how in his early life he was a robber, supposing him to be Barabbas. Another, on the Feast of S. John before the Latin Gate, informed his congregation that he was the man who had brought Latin into Britain, for *ante* was "first," *portam* was "he

brought," *Latnam*, "the Latin tongue,"—and "into England or Britan" was to be understood. He tells how the Norman bishops alienated the lands to members of their families, how they lived as absentees from their dioceses, committing the temporal cares, that is, the extortion of money, to unprincipled officials, and how hungry and disreputable English adventurers trooped into Wales to snap up the ecclesiastical benefices as fast as they fell vacant. The Norman invaders plundered the parishes to enrich abbeys they had founded, and introduced a host of foreign monks, disreputable, indolent, and vicious. Giraldus tells stories of their conduct, how they were sent out to live in cells singly, where they at once took to them female companions. "Go back to my abbey!" said a monk to friendly advice; "I had rather go to hell" Gerald tells of one whose conduct was so scandalous that the castellan of Milford threw him into prison, and his "amica" was set in the pillory. But beside their incontinence, of which, says Gerald, *melius est silere quam loqui*, their drunkenness and gluttony were proverbial, and they were perfectly unscrupulous as to the way in which they extended their possessions—by moving landmarks at night, by cajoling dying persons to make bequests, and, he might have added, by forging donations of estates.

It was the policy of the crown and the barons to impoverish the Church, lest the Welsh spirit should gather head in the parish churches. They therefore gave away great tithes and glebe to the monasteries, some in Normandy, some in England. When the Cistercian and other abbeys were founded in Wales they were filled with men of foreign extraction, and proved English fortresses in the midst of the land. These monasteries were sponges sucking in the endowments of the Church. Let us take an instance or two. Cynwyl Gaio has annexed to it Llansawyl,

a daughter church The area of the parish is 36,437 acres, and is something like fifteen miles across. There must be a curate kept, and for vicar and curate the gross receipts were £274, now, at reduced value, £180 Formerly there were some eight churches or chapels, now only two Or again, Cynwyl Elvet and Abernant have the acreage of 19,560, and there are two churches, two clergy to be maintained, and the value is, gross, £224, actually under £150.

The Welsh in the Middle Ages had to support an alien clergy, alien monks, as well as alien feudal lords. So entirely was the Welsh Church expropriated for the benefit of the English, that even so late as the reigns of the Lancastrian Henrys no Welshman might be educated so as to qualify him to hold an ecclesiastical benefice, and so completely trodden under and despised were the Welsh people, that an Englishman who married a Welshwoman lost all his rights as a freeborn Englishman. These atrocious laws were only in part repealed under the Tudor sovereigns. One might have anticipated that when a Welshman came to the throne of England he would have done something to give to his native land and the people of his fathers some of that for which they had aspired for centuries It was not so The policy of Henry VIII was to complete the union of England and Wales, politically and ecclesiastically. The confiscation of the property of the monastic houses led to no improvement whatever. The monks did hold services in the numerous chapels on their lands, but now the land that was confiscated was given to zealous servants of the king among the laity, and the thousands of chapels fell into ruin, and the parochial clergy remained in indigence.

The wrong done to the sensitive, religious-minded Welsh people sunk deep into their hearts, and a feeling of resentment was nurtured that was destined to last for long.

It is significant to note how entirely the Welsh writers, the poets of the Middle Ages, held themselves aloof from the Church, they wrote as though uninfluenced by Christianity, and this points to the simmering bitterness that filled every native heart. It would seem as though it were a law of God that when a great wrong has been done it should be redressed, and reprisals taken on the offender at some time by the representative of those who had been outraged.

It is surely remarkable that when the Norman Angevin house died 'out in its male representatives, and when a Welshman ascended the throne, that the day of retribution should dawn. By the sword of the Norman the Papacy had mown down the national Christianity of the Celtic race, and with the Welsh Henry Tudor, second of that house, the sword was turned to drive the Papacy for ever out of domination over the hearts and consciences of Welsh, and Scots, and Englishmen.

In Ireland something of the same course had been pursued. The see of Dublin, founded in 1040, alone obeyed Rome, and that was founded by the Danes, and was totally distinct from the Irish Church. It looked to Canterbury, not to Armagh. The other Danish settlements followed suit, and planted sees at Waterford and Limerick under Roman obedience. S. Malachy, steeped in Latin notions, contrived the capture of Armagh, but it was not till after the conquest of Ireland by Strongbow in 1170-72 that the Irish Church was reduced to Roman conformity. The Papacy had long resented the independence of this Church, and had coveted the opportunity for its subjugation. It needed a ready and unscrupulous servant. Pope Hadrian IV. found the man he wanted in Henry II. He declared that Ireland and all islands converted to Christianity belonged to the special jurisdiction

of S Peter, and by virtue of this power he granted Ireland to Henry II of England. The tribute of Peter's pence from the conquered island was to be his reward. Henry was authorised "to enter the island, to subject its people to obedience of laws, to eradicate the seeds of vice, and also *to make every house pay an annual tribute of one penny to the blessed Peter*, and preserve the rights of the Church of that land whole and entire "

Thus was a free, vigorous, intelligent people sacrificed for a penny a household, to be trampled on, murdered, enslaved by Norman adventurers. The bull was granted in 1155. Thenceforth, as Gerald de Barri, who accompanied the invaders, writes, "The clergy (in Ireland) were reduced to beggary, the cathedral churches mourned, having been plundered by the adventurers of the lands and ample estates which had been formerly granted to them faithfully and devoutly. And thus," adds Gerald, "the exalting of the Church has been fruitful in its spoliation and plundering." Of the ministers of the Papal See, the Anglo-Norman conquerors, he says—and they were many of them his own relatives—"This new and bloody conquest has been defiled by an enormous effusion of blood, and the slaughter of a Christian people."

The sense of wrong done, and rankling for so many centuries in Celtic hearts, produced conflicting results eventually. In Wales the population was entirely indifferent to the Reformation. It had been indifferent to the Papalised Church because manned by aliens; it was as indifferent to the Reformed Church, because that was as unnational as before. They regarded the occupants of the thrones of S. David, S. Teilo, and S. Asaph, as also those of the churches everywhere founded and named after Celtic saints, as aliens, and when the opportunity came, in Nonconformity, sought to found a religion for themselves on

their own lines, in complete independence, and in undying hostility to the Established Church.

In Ireland, on the other hand, with characteristic wrong-headedness, the Irish people, *because* the Reformed Church occupied the old benefices, lived on the old endowments, held the cathedrals and parochial churches, revolted in favour of that Church which had done to Ireland the cruellest wrong that could have been inflicted, by selling it into the hand of the English king at a penny a household.

In Wales the Church had been plundered by the Normans; great numbers of the benefices had been reduced to vicarages, that the great tithes might go to abbeys, but the monks did strive to do their duty by the people. The country was covered with little chapels in every hamlet, at no great distance from one another, in which the Word of God was preached, and souls were ministered to. But with the Reformation the revenues of the monasteries were confiscated, and they were destroyed. Thenceforth the parochial clergy were left in comparative poverty, with large parishes, a population very scattered, and wholly unable to cope with the spiritual needs of their people, however desirous they might be of doing so. The Welsh national and ecclesiastical organisations were never allowed free development. That which was foreign to the genius of the people was forced upon them. The tribal system is killed entirely; but they have attempted in Nonconformity to set up what is a spontaneous and living expression of their aspirations and needs.

And to a century of Nonconformity Wales owes more than to eight centuries of the Church. Welsh Nonconformity has transformed and regenerated Wales. It has cultivated both the spiritual and the intellectual powers of the people to a most remarkable degree. The Welsh peasant of to-day is a head taller, intellectually, than the English

labourer He takes his stand beside the Scotchman. The Nonconformist ministry has produced men of first-rate ability and true leaders of men, not only so, but students passionately devoted to learning. In the century of its existence Nonconformity has passed through and out of the initial stage of an emotional religion. At first it was the appeal to the religious hunger of the unsatisfied soul. But all emotional religion is dangerous, as conducive to the substitution of feeling for moral obedience. Nonconformity in Wales has gone out of this stage, and is now cultivating the reasoning faculties of its members. The rock ahead on which it may split is Rationalism. It may, in its zeal for the cultivation of thought, lose its power over the spiritual part of man, and here it is that there is a hope for the Church. That always appeals to the devotional instincts of the soul, and when Nonconformity ceases to do that, then the Church will recover her old grasp on the Welsh people. But that will only be when the Apostolic spirit is revived in her, and when place-hunting, astuteness in controversy and in manipulating promotions and clutching at places, are not prime considerations, but rather the turning the hearts of the disobedient to the Wisdom of the Just. At Pumsaint, in Caermarthen, sleep the five sons of Cynyr, of the race of Cunedda, under a rock in the old Roman gold-mines of Gogofau. They sleep a magic sleep, till the Spirit of God breathes again over the Church in Wales, and an apostle sits on the seat of S. David. Four times have they turned their stone pillow, and into all four sides have their heads worn holes. They have cast aside this bolster and have taken another. They have not as yet sat up and begun to speak.

In conclusion, a few words must be added on certain peculiarities that characterised the Celtic saints.

It has been said that the Church among the Celts passed through stages of development. The first stage was that in which the professed Christians lived together as a saintly tribe, subject to the saint who was their chieftain. The second stage was that of the great monastic foundations. This was one where women, and such as were not monks, were turned out of the *caer* in which the religious lived. The remains of one such monastic settlement on a small scale is seen in Skellig Michael, in the county of Kerry. Each monk occupied a small stone bee-hive hut, and they had little rectangular oratories.

This was a period in which learning was in great repute, and to each monastery was attached a school. The knowledge of Greek was widely prosecuted, and the Latin authors were extensively read. "The Irish schools," says Professor Stokes—and the same may be said of the Welsh—"developed themselves in accordance with their own genius. They had one pre-eminent quality, distinguishing them from too many of their descendants—they pursued learning for its own sake. They did not require to be bribed by prizes and scholarships. They conceived, and rightly conceived, that learning was its own reward. The schools had moderate landed endowments, and their teaching was apparently free to all, or, at any rate, imparted at a very low charge. Bede tells us that the Irish professors were in the habit of receiving English pupils, educating, feeding, and supplying them with books, without making any charge at all. They lived under very simple conditions of society. They had no solid halls or buildings, a few wattled huts constituted their college. They taught and studied in the open air, just as in the hedge schools of former days which Carleton depicts. Yet they had an organised system. They had usually a chief or senior lecturer. They had professors of law, of poetry, of history,

and of other branches of education. They had a steward, who managed the temporal affairs of the institution ”¹

It was probably from the East, through that entrancing, soul-moving work, the “Lives of the Fathers of the Desert,” that asceticism found its way into the Celtic Church, and at once, with characteristic enthusiasm, the Celtic hermit carried it to extravagance. We have indeed only the late biographies of the Celtic saints, and we do not know to what extent the mediæval writers exaggerated the austerities of the ancient ascetics, but their customs were so odd that we can hardly attribute them to mere invention.

S Judicael, we are told, delighted in standing stark naked to his neck in ice-cold water whilst reciting the psalter, Iltyd did the same at midnight, remaining in the water till he had repeated the Lord’s Prayer thrice; S. Fiech took with him five cakes into solitude, whereon to subsist during Lent, and at Easter reappeared with one unconsumed. Their austerities bordered on grotesqueness. One would sleep among corpses, and suspend himself on the points of sickles placed under his armpits; another would keep a stone in his mouth throughout Lent, and a female saint, named Ita, allowed a stag-beetle to gnaw out her side S Winwaloe slept on nut-shells, and put stones for his pillow. But these biographies were composed by Latin monks, alien in nationality, out of traditional tales and ballads, many centuries after the death of those of whom they wrote, and it would appear as though the natives, Welsh, and above all Irish, delighted in palming off on their interrogators any nonsense that their lively imaginations could conjure up. It is amusing, among other things, to note how some of the real facts puzzled the writers, and how they endeavoured to alter them in accordance with their Latin prejudices

¹ Stokes, “Ireland and the Celtic Church,” p 229

A peculiar custom in the Celtic Church was that of dedication of a church or ecclesiastical colony. According to the Roman usage every church must be a shrine over a relic, and the church takes its title from the relic preserved in it. The Celtic Church had its *martyria*, but these were exceptional. In it, it was customary for a holy man or woman who desired to found a *llan*, to go to the spot and continue there in prayer and fasting for forty days and nights; during all that time it was incumbent on him to eat nothing save a morsel of bread and an egg, and to drink only milk and water, and that once in the day. The Sundays were excepted. This done, the place was regarded as consecrated for ever. The church thenceforth bore the *founder's* name, and it may be pretty certainly, though not always, concluded that where a church bears the title of a Celtic saint, if of early foundation, it was actually consecrated by that person in the manner described. This was not always the case, at a later period churches established under direct rule of a famous abbey, either of S. Teilo or S. David, would be called S. Teilo's or S. David's church, not because actually founded by the saints, but because erected by those who belonged to the original establishment of Teilo or David, and were to be served from the monasteries of these saints.

There was a third stage in the development of the Church in Celtic countries, and that was when the secular priests and the bishops were independent of the great abbeys. Marriage was usual among them; indeed, always had been when under the rule of the ecclesiastical chief or abbot. It appears from the Epistle of Gildas that the British clergy in his day—the sixth century—did not profess celibacy, and until 961 the marriage of the clergy was not only not forbidden, but was recognised. A passage in the Dimetian Code provides that a son of a priest born before his father's

ordination has no right to a share in his ecclesiastical benefice, but that a son born afterwards would have a legal claim thereto, because the first son, not belonging to the sacred tribe, would obviously have no claim on tribal rights to which his father had not been admitted at the time. In the canons, said to have been made at a synod of SS Patrick, Auxilius, and Isserninus, the sixth regulates the dress to be worn by the wives of the clergy.

Giraldus Cambrensis, in the twelfth century, was greatly shocked Benefices passed in many instances regularly from father to son, and these even in the cathedral. The sons of the canons married the canons' daughters, and the cathedral had altogether the appearance of a happy family party. He says that under the very shadow of the cathedral nurses and cradles were to be seen. The Archdeacon of Bangor, an old man named Jordan, was married. Giraldus, at the time administrator of the authority of the Papal legate, reprimanded him. The archdeacon disregarded the notice. Then Giraldus appealed to the Archbishop of Canterbury, who sent him an admonition. On receiving this the archdeacon appears to have forgotten his dignity, and to have launched into very unclerical language at the expense of the archbishop. At length Giraldus got the old man removed from his archdeaconry and prebend and transferred to a less conspicuous position, whereupon Giraldus seized on the vacant dignities for himself.

He draws a ludicrous picture of the parish priest jogging to market, his good woman sitting before and he behind, holding on with his arms about her waist.

But there was an abuse growing out of this, that of the benefices becoming family property: Giraldus stayed a night in one which belonged to six ecclesiastics of the same family

A great deal more credit has been given to Augustine and his mission for work done in the evangelisation of

England than they deserve. Augustine's mission came after the whole of Celtic Britain and Ireland, and a portion of Caledonia, had believed, and that for centuries. It was true that where Saxon and Angle arms prevailed, there the native British Church had been swept out. But Augustine's mission was a success for a brief period only, and then met with discomfiture. Later on it obtained some advantage among the Saxons of Kent and Wessex, but Mercia and Northumbria were converted, not by these Latin missionaries, but by the missionaries of the Celtic Church in Iona, and in Wales, Devon, and Cornwall the primitive British Church lived on. It had a stronghold at Glastonbury, which Ina, the Saxon, respected. In time, owing to the persistency, the assurance, and the organisation of the Latin Church, it prevailed, but it reaped where it had not sowed, and gathered where it had not strawed; and never was the saying more fully verified than in the Latinised English Church, "One soweth, and another reapeth."

With respect to the liturgy of the Celtic Church, whether in Ireland, Scotland, or Wales, we have a certain amount of material by which we can understand what it was as well as what it was not. The material has been collected and published by Mr. Warren in his "Liturgy and Ritual of the Celtic Church" (Oxford, Clarendon Press, 1871), and it has also been critically investigated by him. In what follows concerning this liturgy, I can do no more than condense the amount of information collected in that admirable treatise. But, in the first place, except for the passing wave of Pelagianism, that was allayed as speedily as it arose, there was no charge of heresy that could be substantiated against the Church in the British Isles. S. Hilary of Poitiers in 358 congratulated the bishops of the British provinces on "their having continued uncontaminated and uninjured by any contact

with the damnable heresy (of Arius)." Athanasius in 363 stated that the British Churches had signified to him by letter that they adhered to the Nicene faith. S Chrysostom (386-398) declared that "even the British Isles had felt the power of the Word, for there also churches and altars had been erected. There also, as on the shores of the Euxine or in the south, men might be heard discussing points of Scripture, with differing voices but not with differing belief, with varying tongues but not with varying faith." S Jerome (circa 400) asserted that "Britain in common with Rome, Gaul, Africa, Persia, the East, and India, adored one Christ, and observed one Rule of Faith." Venantius Fortunatus (circa 580) testified to British orthodoxy in the sixth century. Even Wilfrid, imbued with a malignant hatred of Celtic Christianity, did not venture to deny its orthodoxy. When present in Rome, 680, at a council of bishops held in anticipation of the Œcumenical Council of Constantinople in the same year, he asserted that the true Catholic faith was held by the Irish, Scottish, and British, as well as by his favoured Romanised Anglo-Saxon Church. It had therefore been no vain boast of S. Columbanus to Pope Boniface in 612, that his Church was not schismatical nor heretical, but that it held the Catholic faith in its integrity.

"Had it been otherwise, could British bishops have been present certainly at the Council of Arles A.D. 314, perhaps at Nice A.D. 325, probably at Sardica A.D. 347? Could the conferences have taken place at Augustine's Oak A.D. 603, and at Whitby A.D. 664, without at all events far more serious questions having been raised than the form of the tonsure, or the calculation of Easter? Would Wini, Bishop of Winchester, have associated two British bishops with himself in the consecration of S. Chad A.D. 664? Both direct testimony and indirect inference

lead us to conclude with reference to the whole Celtic Church what Montalembert allows with regard to primitive Ireland, that it was 'profoundly and unchangeably Catholic in doctrine, but separated from Rome in various points of discipline and liturgy.'"¹

So far, then, seems established, that in doctrine the Celtic Church in nothing differed from the Roman, Gallican, and Eastern Churches. In the matter of Order, there can be no doubt that there were bishops, priests, and deacons in it, as elsewhere in the Catholic Church. The difference was confined to this—that the jurisdiction was not necessarily in the hands of bishops, but in those of the head of the ecclesiastical tribe.

It was, however, rapidly assimilating its system to that prevalent among the English, Franks, and among the Latin races. The Celtic Church never believed that the sacred commission could devolve save through the imposition of hands and invocation of the Holy Ghost, by bishops apostolically consecrated. What was peculiar in the Celtic Church was that Episcopal consecration could be conferred by a single bishop. In Ireland this custom still obtained in the eleventh century, and was complained of by S. Anselm, writing to the Irish king Turlagh, in 1074, and by Lanfranc, writing to King Muriardach, in 1100. By a curious misconception of the canon of Arles, the Celtic Church always consecrated three bishops at once, but by a single ordaining bishop. There was also this difference in the ordination of priests and deacons, that in the Celtic Church their hands were anointed; and this peculiarity found its way into the York Anglo-Saxon Church, for it occurs in the Pontifical of Egbert (732-766); it even penetrated to southern England, for it is found in the Anglo-Saxon Ordinal of S. Dunstan.

¹ Warren, p. 29

There were other slight differences that need not detain us. Let us now pass to the liturgy in use in the Celtic Church and to the ritual attending it.

The Liturgy was intitled the Communion of the Altar and also the Sacrifice, and the Welsh word for a priest, *offwr*, is derived from *offerre*, to offer, that is to say, *sacra offerre* or *offerre sacrificium*. A peculiar feature of the altar service was the multiplicity of Collects. In the early Roman liturgy there was but one, and the custom that now prevails of accumulating the Collects of the day and season did not come into use in the Latin Church till late. It was one of the charges made by Agrestus against Columbanus that he recited several Collects at Mass instead of only one. Not only was there a reading of Epistle and Gospel, but also of a lesson from the Old Testament; but this indeed was a legacy from the primitive Church, and traces of it still remain in the Roman Missal.

It was customary to commemorate the departed. Diptychs containing the names of the deceased were brought to the celebrant, and their contents announced by him during the offertory. Then ensued an anthem called the "deprecatio," containing an enumeration of the names of those departed saints for whose repose the prayers of the congregation were requested, and of those by whose intercession such prayers would be assisted. It is interesting to note that the commemoration of the dead introduced by the English Reformers into the prayer for all sorts and conditions of men occupies precisely the place of the Celtic "deprecatio," whereas in the Roman Mass the commemoration of the dead occupies quite a different position.

The prayer of consecration was said in an audible voice, and contained the recitation of the Institution.

In the ancient Irish Church, after the Consecration, a

hymn was sung, "Sancti venite," which called the faithful to communion. This hymn, which has happily been preserved in the Bangor Antiphonary, and also in MS at S. Gall, and in the Stowe Missal, has been reintroduced by the compilers of Hymns Ancient and Modern, and is now again familiar in the British Isles, "Draw nigh and take the Body of the Lord."

The position occupied by the priest was before the altar, that is to say, facing the east, and with his back to the congregation. Special vestments were in use. S. Bridget, we are told, "gave away to the poor the transmarine and foreign vestments of Bishop Condladh, of glorious light, which he was accustomed to use when offering the Holy Mysteries at the altars, on the festivals of our Lord and the vigils of the Apostles."

Among the special vestments of which we have proof of existence are these:—1. The chasuble. This was circular, with embroidered orphreys, and is so represented in the eighth-century reliquary of S. Maedoc, and on the Book of Deer, ninth century. 2 On the breast Celtic bishops wore the *rationale*, a sort of breastplate like that borne by Aaron and the High Priest under the Jewish dispensation. It was made of gold or silver, studded with precious stones. It continued in use in many places during the Middle Ages—at Corvey, at Salzburg, and at Chartres. A Pope is represented at Rheims on the south door as wearing one.¹ 3. Celtic bishops bore pastoral staves, not crooked like those in use in the Middle Ages, and in place of mitres had crowns on their heads. S. Samson, about 557, dreamed that he saw "three eminent bishops adorned with golden crowns standing before him" The use of this crown in a modified form continued in Anglo-Saxon times until the tenth century,

¹ Bock, *Geschichte der Liturgischen Gewänder* (Bonn, 1859), vol. 1. p. 382

when representations of the mitre begin to appear, low and two horned, and as such it is seen on the Culbinsgath stone, Shetland, where also the bishops are shown with crooked staves.

The colours in use seem to have been purple for ordinary Sundays, and white for festivals. Gildas refers to the custom of covering altars in British churches with purple palls. The three choirs of saints which appeared to S. Brendan were clad in vestments of the most shining purple jacinth. S. Cuthbert was buried in a purple dalmatic, 687. It will be remembered how largely purple enters into the earliest extant specimens of Celtic illumination, and Bede alludes to the ease with which a red or purple dye could be obtained from shells on the Irish coasts, and this explains the preponderating ecclesiastical use of this colour ¹

A very singular usage existed at Iona of two or more priests being ordinarily united in the Eucharistic act of consecration; to consecrate singly was held to be the prerogative of bishops, or of individual priests specially empowered to so consecrate on account of their eminence or sanctity.

Adamnan records how "on one occasion a stranger from the province of Munster, who, through humility, concealed the fact that he was a bishop, was invited, on the next Sunday, by Columba to join with him in consecrating the Body of Christ, that as two priests they might break the bread of the Lord together. Columba, on going to the altar, discovered his rank, and thus addressed him: 'Christ bless thee, brother; consecrate alone as a bishop, now we know that thou art of Episcopal rank. Why hast thou

¹ The general use of red in the Sarum order, and its traditional employment in England to this day as the ordinary Sunday colour, points to this early custom. Red and purple were indiscriminate colours at one time.

endeavoured to disguise thyself so long, and to prevent our giving thee the honour due to thee?"

No similar practice existed in any other country, or at any other time, in fact, something exactly opposed to it existed in an obsolete rule of the Latin Church, that when a *bishop* celebrated, the priests present should unite with him in the words and acts of consecration. Contrary to the usage of the Latin Church, the Celtic Church employed unleavened bread. Gildas makes this one of his charges against it. "The Britons, opposed to all the world, hostile to Roman usages, not only in the Mass, but even in the tonsure, sheltering themselves under the shadow of the Jews." At S. Gall, an Irish monastery in Switzerland, unleavened bread was used. It was from the Celtic Church that the Anglo-Saxons adopted it. The Roman Church did not abandon leavened bread till the tenth century.

It is hardly necessary to add that in the Celtic Church communion was in both kinds

There is no trace of a vernacular liturgy. Evidently that in employ was one derived from Gaul, and no attempt was made to translate it, but sermons were delivered in the tongue understood by the people, and the Gospel and Epistle were doubtless translated, and possibly there were vernacular hymns. There certainly was singing, and we are told that when S. Columba chanted his voice could be heard a mile away

It was customary in the Irish and British Churches to distribute the Eulogiæ, blessed, but not consecrated bread, at the conclusion of the liturgy; and this usage once general, except in the Roman Church, continues to the present day in the Greek and Russian, as also in the Gallican Church, where the visitors to, let us say, Notre Dame at Paris, on a festival, will be brought the *pain bénit*.

Adamnan says that in S. Cainech's monastery at Aghaboe

there was a table in the refectory on which the Eulogæ were cut up for distribution. The same practice existed at Iona. At Lindisfarne, in S. Cuthbert's time, the blessed bread was distributed after Mass.

The Eucharist was not celebrated daily, but on Sundays and Saints' days, very early "in the morning" by S. Columbanus, by S. Gall "at daybreak," by S. Brendan "in the very early morning," and an early Mass was ordered in the continental Irish monasteries.

Confession was strongly urged, but it was made in public before priest and congregation, and it was perhaps due to this publicity that the custom of making confession had died out in Ireland, as S. Bernard asserts, in the twelfth century. In the Penitential of Cummine it is plainly taught that confession before priest and people was optional, "confession to God alone, if there be need for it, is allowable." Absolution was not given, in contradistinction to Roman practice, until the penitent had fulfilled his penance, and then only by the priest who had imposed it. Bede tells the story of a youth who made confession to a priest, and on hearing the penance imposed complained of it because it was for an indefinite time, and absolution was deferred until the priest should see him again. In the meantime the priest died, and the youth continued to comply with the conditions of penance for the rest of his life. The English reformed usage of making a general confession before communion, and a general absolution being pronounced, is a return to Celtic usage, in so far as that both are public.

The remains of the Celtic liturgy are not numerous. There is a Cornish fragment from S. Germans, once a cathedral, and it is a Mass of S. German. It is of the ninth century, and was composed after the Cornish Church had fallen under Anglo-Saxon influence. A Scottish frag-

ment has been found within a blank page of the Book of Deer, sufficient to show that the Scoto-Pictish liturgy of the Columban Church belonged to the "Ephesine," and not to the "Petrine," family of liturgies.

Some Irish fragments bearing the same testimony are found in the Books of Dimma (seventh century) and Moling (end of the seventh century). The Book of Armagh contains another, further and larger fragments have been discovered at S. Gall and at Basle. The antiphony of Bangor not only contains the hymn "Sancti venite," but a creed that differs in wording from all other forms known to exist, and which had a liturgical position found only in the Mozarabic rite.

But the most complete is the Stowe Missal, that originally belonged to some church in Munster, and was carried to Ratisbon about 1130, but has been recovered. This Missal does not indeed belong to the Celtic Church before it had passed under Latinising influence. It shows us that the Roman Canon had been introduced into at least partial use in Ireland as early as the ninth century; but it retains certain portions of the earlier national liturgy, and this is interwoven with the new introduction. Nor is it only the Roman which is present in this interesting composite Mass; there are passages in it from Ambrosian, Gallican, and Mozarabic rites, suggestive of that period of diversity when, as Tirechan wrote in the eighth century, "There were holy priests and few bishops"—in the period between 572 and 666—"one hundred in number. . . They had different rules and masses, and different tonsures—and a different Paschal festival" And the period preceding this, he says, from 534 to 572, "Was one when there were few bishops and many priests, in number three hundred. They had one head, one Lord, they had different masses and different rules. And they had received a Mass from Bishop

David, and Gildas, and Ca(docus) the Britons” But in the first age, from about 440 to 534, he says, “They were all bishops, famous and holy, and full of the Holy Ghost, 350 in number, founders of churches. They had one head, Christ; and one chief, Patrick; they had one mass, one celebration, and one tonsure.”

Such, then, was the Celtic Church in Faith, Order, and method of Worship—a Church full of apostolic zeal, fired with missionary fervour.

When the Saxon was master of the land he did not relish to have to pay his devotions in a church dedicated to a saint of the subjugated and hated race, he could not invoke him, for he supposed that the good old Celtic saint hated him, and would fight against him in heaven. He was therefore desirous of having his church re-dedicated, if not to one of his own race, at all events to one of the Roman kalendar. And he was warmly supported by the prelates, who also detested and denounced the ancient British Church as schismatical and heretical. The result was that English and Norman bishops swept away the names of the founders wherever they could. Only rarely was the remembrance of the old saint tough enough in the hearts of the people to resist the change. In Devon the whole of the south-east was purged in this manner. But in North Devon a good many of the ancient founders held their own. S. Brendan sheltered under Exmoor, S. Petroc at Anstey; Thelbridge, dedicated to S. David, was tolerated because David had been canonised by Rome; Lan Kea was re-dedicated to S. Paul, but is still Land Key; Swimbridge retained an altar to S. Bridget; Braunton would not give up S. Brynach. Two churches of S. Elen were spared, Parracombe and Abbotsham, because the wife of Maccsen Wledig was mistaken for the mother of Constantine. Perhaps as a badge of subjection, Heanton

Punshcardon was dedicated to S Augustine, yet this may have been to the saint of Hippo. The Saxon Werbrugh was carried to Warbstow, on the confines of Cornwall. S. Curg had everywhere to give way for S. Cyriacus, a boy martyr of Tarsus; and S. Julitta or Gwenn, the mother of S. Padarn, disappeared behind Julitta, the mother of Cyriacus. S. Gwynws became S Genes, the comedian; and S. Cyby was disguised as S. Cuthbert. S Hilary of Poitiers replaced both S. Elian and S. Teilo. Where the devotion to the old saint was too strong to be suppressed at once, an approved kalendar saint was coupled with him, in hopes that in time he would smother the ancient Celt. Thus S. Stephen was joined with S. Mawgan at Mawnan, S. Dunstan with S. Manaccus at Lanlivery, and at Lanreath; S. Non would have been changed into S. Mary if the mediæval church authorities could have induced the parishioners of Altarnon to accept the change. Yet this substitution was not always due to ecclesiastical prejudice. It arose very much from the fact that the local saint was so local, and so devoid of a legend, that the bishop, when reconsecrating the rebuilt church, deemed it expedient to supplant him by some one whose story was known. In 1330 Bishop Grandisson of Exeter wrote to the Archdeacon of Cornwall complaining of the negligence or accidents which had occasioned the loss of the records of the lives of many Cornish saints, and enjoining that two, or even three, copies of the legends of such as remained in the parish churches dedicated to their memory should be made and transmitted to Exeter. It is, and must be, a matter of bitter regret that the documents thus collected, and which would have thrown a flood of light on the history of Cornwall, cannot now be traced.

It has been, and is still, very much the fashion to decry the ancient Celtic Church, and to accept Gildas as a true witness against it. Thus Professor W. E. Collins, in a

series of lectures on the Early Church in our islands, says : "The evidence all points, and points irresistibly, to the conclusion that Christianity in Roman Britain was a weak thing" And again, "The British Church was in the highest degree weak, wanting in initiative, and debased both in faith and morals." This may possibly be true of the Romano-British Church, but we know really nothing about it, because every trace was obliterated by the advancing Saxons in blood and fire That it was true of the Church in Wales and Cornwall, and in Ireland, may be greatly doubted We have, indeed, the invective of Gildas, but he was clearly a violent, scurrilous writer, who took a delight, like an ill bird, in befouling his own nest, and the reason was that he belonged to the party which was anti-national in Church matters—he desired to bring the British Church into conformity with that in Gaul and in Rome It is said that Augustine and his successors taunted the bishops of the British Church with doing nothing for the conversion of the invaders But we may well inquire, Was it likely that the invaders would suffer them? and the Celtic Church later on nobly redeemed the charge, for, as Bishop Lightfoot has said, "Aidan, and not Augustine, was the Apostle of England" Bede looked with abhorrence on the Celtic Church, yet he was compelled to admit the saintly lives of its bishops, and the zeal of its missionaries. Aldhelm of Sherborne wrote to Geruntius, Prince of Domnonia, in 705, and the "enormities" committed by the British believers in Christ he limited to the Celtic tonsure, to the wrong keeping of Easter, and to a few like trifles. As Mr. Newell says. "The importance of Aldhelm's letter does not lie in the conversions it effected, so much as in the contemporaneous picture it presents of the condition of the Church in Wales It is evident from the language of Aldhelm that the Welsh Christians were pure

in doctrine, and at least so far pure in morals, that none of the English Christians could venture to cast the first stone against them. They even seem to have laid claim to a morality superior to that of the English, which Aldhelm is forced to acknowledge, though he deems such holiness worthless on account of their state of schism. It does not appear that he refrained from offensive charges out of courtesy to those whom he addressed; he rather magnified their faults, or, at least, used much plainness of speech, so that his testimony to the virtues of the Britons, and especially of the Welsh, is the more valuable, as extorted from an enemy."

It would be easy, looking at the horrible picture of the Frank monarchs as painted for us by Gregory of Tours, to pronounce against Gaul, Woe! woe! and deny to the Christianity professed by the Franks recuperative power. The times were those of violence. The condition in which were the Britons was one of discomfiture. Their faults were those of their national lack of organisation. But to accept what has been said by her mortal enemies against a Church which had not the means of replying, is to act on the adage, "Give a dog a bad name, and hang him."

When Gerald de Barri wrote in the twelfth century, he admitted the high quality of religion among the Welsh. "They give the first piece broken off every loaf of bread to the poor; they sit down to dinner by three to a dish, in honour of the Trinity. With extended arms and bowed head they ask a blessing of every priest or monk, or of every person in a religious habit. They covet, above all other nations, the episcopal ordination and unction, by which the grace of the Spirit is given. They give a tenth of all their property, . . . either when they marry or go on pilgrimage, or are persuaded to amend their lives." He goes on to speak of their kindness to animals. "Hermits

and anchorites more strictly abstinent and more spiritual can nowhere be found, for this nation is earnest in all its pursuits, and neither worse men than the bad, nor better men than the good, can be met with anywhere."

The Welsh had their faults—they were passionate, revengeful, often engaged in fratricidal warfare. Gerald condemns their system of ecclesiastical organisation, or rather, their lack of it, and the hereditary succession to ecclesiastical jurisdiction, and he denounces the sin of incest common among the Welsh princes, but means by this expression no more than marriages within the fourth degree, without those contracting it feeing Rome to grant them dispensations.

No Church has been more misrepresented and maltreated than has the ancient Celtic Church, yet no Church with such small means, and under such difficulties, achieved greater things, and did more for religion in Europe.

It is true that the Celtic races stood on a lower stage of political organisation than their several conquerors. It is this, and this alone, that explains the conquest of Britain by the Saxons. It is this that explains the manner in which Wales fell an easy prey to Norman adventurers, and that Ireland in like manner was mastered by Strongbow and Henry II.

The Feudal system was a great and grand creation of the Teutonic genius under the influence of Christianity. It accepted the Christian principle, that every privilege involves corresponding duties. No man liveth or dieth to himself alone. Each man who received an office owed allegiance to him by whom the office was conferred, and forfeited it if he neglected the duties it involved. All power, all authority devolved from God for certain just purposes. Feudalism did much towards the development of the sense of *duty* so strong in the English and German

mind. Moreover, Feudalism compacted all who submitted to it into one body, that moved with irresistible and crushing force against such as were loosely and arbitrarily united. In Celtic tribalism was no cohesion based on principle. It depended on the arbitrary will, the caprice of chiefs, whether they combined or fought independently.

The characteristic trend of Celtic genius is towards republicanism, but it is a republicanism that is ready at any moment to resolve itself into blind adhesion to a chief who knows how to captivate the imagination. The Celt has always loved, and rightly, to have his say on all topics connected with his religion, his social and political organisation, and not only to have his say thereon, but to control it.

Perhaps we have an excellent illustration of the trend of the Celtic mind in the outbreak of the French Revolution, leading to Imperialism under Napoleon I. This was the rising of a great nation, largely Celtic, against the absolutism of the French monarchy utterly opposed to its ideals, to assert those principles which lay deep in its heart, and when this was done, and produced wrongs great and crying, because suddenly introduced instead of having been slowly evolved, in sequence, tested and verified, it abandoned itself to absolutism again under another form, but only so long as its imagination was impressed by the grandeur of Napoleon.

In religious matters the Celt is an enthusiast; the love and fear of God are perhaps more deeply seated in him than in any other race of men. As Sir Roland L. Vaughan-Williams has truly said, "Enthusiasm in religion is, I think you will agree with me, characteristic of the Welsh, nay, more, characteristic of the Celtic race; and I trust you will further agree with me, that another characteristic of the Celts is the ardent desire, amounting almost to a passion,

that their institutions, whether civil or ecclesiastical, shall have a local character.”¹

The great defect of the Celt is impatience. He is penetrating in intellect, but he has not the temper that will allow an idea to work itself out slowly, modifying itself to suit times and circumstances. Here it is that the ass-like stolidity and stubbornness of the Saxon nature avails. The English mind is not clear, its wit is not trenchant; but it is forbearing, patient, and withal resolute.

In the Christian Church we may well speculate what might have been the result had Celtic Christianity been allowed to expand and shape itself logically, and in accordance with the genius of the race.

We know the Church only under the form she adopted consequent on her taking shape in the highly organised Roman world, running itself into the moulds already formed, and insensibly partaking of the leading Roman idea of centralisation, and subjection of every part to the authority at the Capital of the World. Such an ideal agreed with the inarticulate cravings of the Teutonic mind, and the Anglo-Saxon readily lent himself to carry it into effect.

It was the misfortune of the Celt everywhere—in Gaul, in Britain, in Ireland—never to be allowed to work out his own ideas, to develop his own institutions logically to a constituted government on firm basis. Nor was he suffered to mould his Church as most convenient to himself. It is quite true that Christ said, “Ye have not chosen Me, but I have chosen you” (S. John xv. 16), and that all commission and authority must devolve from Him, but this principle may be carried too far, and it is so when the Church is regarded as a sacerdotally ruled body, in which the laity have no rights except to receive

¹ *Transactions of the Hon. Soc. of Cymmrodorion*, 1895, p. 17

the Sacraments. The revolt against the Latin Church in Scotland, in Wales, and in England, as well as that of the Huguenots in France, was to a large extent due to the Latin organisation being opposed to Celtic ideals. Protestantism, Calvinistic and Zwinglian, is a new theory, sprung from the people, created by the people, and has no roots in the past. It was not an outcome of the gradual growth of a constitution from small beginnings—first the blade, then the ear, after that the full corn in the ear—but was a convulsion, like the French Revolution, leading to the exaggeration of certain principles, true in themselves, but with forgetfulness of correlative principles—the Divine origin of the Church, and delegation of authority in God's kingdom.

It is certainly a most hopeful sign, that since the dis-establishment of the Irish Church it has re-shaped itself on these constitutional lines, which are in complete accord with the Celtic spirit. The choice of bishops, the order of Church government, ritual and liturgy, are all determined by diocesan and general synods, at which clergy and laity are represented. The Church thus works as a living entity and an active organism, in accordance with the processes of natural life; but spiritual life comes not from man, but from Him who gives natural life.

Had the Latin Church not trodden out independent Celtic Christianity it is not improbable that in Celtic lands the Church would be found alive, vigorous, one with its past, different in many particulars from the Latin and the Anglican Churches, yet one in faith and one in devotion of authority from Christ, through the Apostles, Catholic in belief, but with the congregational system developed in a way different from that which is parochial, and the episcopal order possibly without jurisdiction, the latter reserved to synods. We may well suspect that in that event there

would have been no Calvinism in Scotland and no Non-conformity in Wales. One fact in the history of the British people should never be lost sight of it is this, "That the Celtic Church, unadulterated by foreign influence, was for nearly half the whole time which has elapsed since the birth of Christ the dominant Church in Wales."¹

The late Mr Green wrote a valuable, but one-sided, work on "The Making of England." That making, in his eyes, consisted in the expulsion of the Briton, and in the accession to mastery of the Latin Church. But surely although it may be through the Anglo-Saxon and the Latin Church working together that England arrived at political unity, yet the imposition of an ecclesiastical system alien to, and distasteful to, the Celt bred the after revolt of the spiritual life, and the expulsion of the foreign element. Moreover, if we look at, not England, but the English, what has been the making of the race? If man be mere flesh, and bread be mere dough, then English men are what they are because of the great Teutonic invasion. Our Anglo-Saxon forebears possessed rare qualities, perseverance, tenacity, and power of organisation; yet the higher qualities in our race, the searching intellect, the bright imagination, above all, idealism, that straining after what is high and pure, are due to the spark of living fire entering the lump of heavy, plodding German nature, through contact with the Celt.

Note.—In confirmation of my view, as opposed to that of Freeman and Green, who say that the Britons were exterminated by the Saxons, Gildas may be quoted, who says of them, "Some, being taken in the mountains, were murdered in great numbers; others, constrained by famine, yielded themselves to be slaves to their foes; others, passed beyond the seas"

¹ Sir R. L. Vaughan-Williams · "Y Cymmrodor," 1895

BRITTANY, ITS PRINCES AND SAINTS



IN the sketch of the Celtic Church and its Saints I have spoken briefly of the colonisation of Armorica from Britain. But the subject is so important, and so little known, that I purpose in the following pages to treat it with more detail. Not only does the history of this colony throw some light on that of Wales and Cornwall during the fifth and two subsequent centuries, but it also serves to illustrate the peculiarities of Celtic ecclesiastical foundations.

The earliest indication of the settlement of British immigrants that we have is afforded by the appearance of Mansuetus, described as "Bishop of the Britons" at the Council of Tours in 461. We might have suspected him to be a visitor on his travels; but we hear shortly after of a considerable body settled in Armorica.

The final conquest of Kent took place in 465, after which, the Anglo-Saxon Chronicle tells us, the Britons "forsook Kentland and fled with much fear to London."

This was the occasion of a schism among the Britons. The Romanised natives of the cities rose in revolt against Vortigern, who had invited over the Jutes, and headed by Aurelius Ambrosius, a descendant of the last Roman general in the island who had assumed the purple, they drove Vortigern into Wales, and undertook the conduct of the war against the invader. We may fix the date of the first large migration to Armorica as happening in consequence of this strife among the Britons themselves. But

previous to this for some time there was assuredly an influx from Devon and Cornwall, as the Celtic political organisation required these periodic swarms, or else, inter-tribal war.

Shortly after the appearance of Mansuetus at Tours we learn from Sidonius Apollinaris, in 469, that the Britons were already settled on the north of the Loire in sufficient numbers to make them important auxiliaries against the invading Visigoths.

In 468 Arvandus, Prefect of Gaul, having involved himself in difficulties, and being discredited at Rome, and expecting his supersession, invited the Barbarians to enter Gaul, and urged them to attack the Britons on the Loire, "as the most useful supporters of the Empire."

From this it is clear that in 460 the colony was one numbering many able-bodied men, and this is confirmed by Jornandes, who tells us that Riothimus, chief of the Britons, came in a fleet of boats, probably up the Loire to Tours, to meet the Visigoths under their king, Euric, and was defeated at Déols, near Châteauroux, in Indre, and, having been cut off from his ships, was forced to fall back on the Burgundians.

In what part of the peninsula the first colony had settled we are not told, but everything leads to the conclusion that it was between the mouths of the Vilaine and the Loire.

About the same period, perhaps 460, a colony arrived on the north coast under one Fragan, which settled near where now stands S Briec. Already S Budoc was settled in the island of Lauret, close to the larger isle of Bréhat. His story is so utterly fabulous, that it is impossible to say whence he came, or when; but as Fragan committed his son to him to be educated, it is clear that he had preceded him by some years.

The colonies settling in Armorica may be grouped into three, exclusive of that under Riothimus. One from Gwent

descended on the north-west coast, where now stands S. Pol de Léon, and established themselves under a native Gwentian prince, and called their principality Léon or Lyonesse, after Caerleon which they had left. It remained an independent state till about 530, when it was united to Domnonia. This latter state extended from Léon to the river Couesnon.

At the time the whole interior of Armorica was occupied by an enormous forest, and the ancient Roman roads only cut across outlying branches, or skirted it. The interior was entirely unexplored, and without inhabitants. In many places this forest sent down dense coppice along the rivers to the sea, to where the winds caught and distorted the trees, and forbade further growth. But the wind-swept stony district of Finisterre was treeless, it was a dreary waste of bog and stony desert.

The Domnonian colony issued, as we may suppose, from Devon, and the colonists gave to their new home the name of that they had left, and were, it would seem, under the rule of the same royal house.

The south-east of the Armorican peninsula received a swarm from Britain of men who called themselves Cernau, and they made their headquarters at Curiosoptum, now Quimper. Here the forest did not extend so greatly towards the sea, and they were therefore able to settle farther inland than the Domnoni of the north. The river Blavet divided them from the Gallo-Roman occupants of the diocese of Vannes.

The monkish writers in later times converted Cernau into Cornavii; and the French called the principality Cornouaille.

Whence came they? The most recent historian of Brittany broaches a truly wondrous theory. He finds that in the times of Roman domination in Britain a body

of fighting men belonging to the Cornavi, the occupants of Cheshire and Shropshire, were engaged to defend the wall of Severus, and their headquarters he conjectures to have been at a settlement just west of Newcastle called Corstopitum. When the Anglo-Saxons and the Picts combined against the Britons, then he supposes that this body of troops—we have not, by the way, the slightest reason for supposing that the Shropshire contingent had continued there for a hundred years after the mention in the *Nottia Dignitatum*—took to their heels, and then to their boats at Chester, and rowed till they had reached Armorica where they founded a new Curiosopitum. The whole theory rests on assumptions—that the Cornavi still defended the wall, and that Curiosopitum in Brittany was named after Corstopitum in Northumberland

But curio is, perhaps, merely a Latinisation of Caerau, and sopitum is from *swp*, an agglomeration, and the name was applicable to any cluster of fortified enclosures.

Nor can these Cornavi have been immigrants from Shropshire, as the Severn valley was not invaded till 583 by Ceawlin, who swept it with fire and sword, and burned Wroxeter. But the Cernau of Brittany had already been settled there a century before that date. We are much more likely to be near the truth if we consider this colonisation to have been from Cornwall, and to have been due to the in-road made in the fifth century by the combined families of Brychan and Gwynnlyw from Brecknock and Gwent, who took possession of so large a tract of land in North Cornwall and Devon. It must be remembered that a Celtic tribe was compelled to send off swarms at fixed periods, for the obligations of the chief towards members of his tribe ceased with the eighth generation, and accordingly an emigration of a cast-off generation was periodically inevitable. There had been descents from Cornwall of such founders of new

tribes for some time on the west coast of Brittany, but when a great mass of settlers came down on the coast of the Cornish peninsula and dispossessed the original owners, these latter moved after their brethren in large fleets. It is possible that the same cause operated in Devon, and produced the founding of Armorican Domnonia. But there was another occasion for these colonising ventures.

Great numbers of Britons fled West from the swords of the Saxons into Dyfnaint or Domnonia, which was otherwise quite unaffected by the Anglo-Saxon invasion till Ceadwalla attacked it in 710, and it was not conquered till between 754 and 766. The great marshy tract of the Parret, the vast bogs about Glastonbury, proved for centuries a barrier against invasion. But fugitives threaded the swamps or crept along the well-fortified high ground that walled off Devon on the side of Dorset, and accumulated in inconvenient numbers in the as yet untroubled land of dales and rivers. They could not all be accommodated there, and it became advisable for the princes to place bands of these refugees under princelings of their own house, to convey them over the sea to build up an auxiliary state in Armorica.

I have already noticed the accounts given of these migrations in the previous article, as given by Procopius and Ermold Nigellus.

Let us now see what was the method adopted in these attempts at colonisation. The chief of a band of settlers on reaching the Armorican coast formed his *plou*, that is to say, tribe. The monkish writers translate *plou* by plebs. They formed a stockaded caer, into which they could retreat in the event of hostilities with the natives, and in which the chief resided. Each family was then granted a *tref*, a home-stead and land about it, for its maintenance. A hundred *trefs* in Wales forms a cantref; the number was, however,

undetermined in a new colony ; but various numbers made up a *plou*, and the land occupied by the immigration was called a *pou* or pagus. After a while this chief sent for an ecclesiastic who was a kinsman, unless one arrived as a colonist, and he gave to him a piece of territory, on which he in turn planted his *llan* (Welsh *llan*), that is to say, made the sacred enclosure in which he reared his church. In Brittany we have plenty of places called Plou, and plenty called Lan. The former mark the central station of the secular, the latter the church of the ecclesiastical tribe.

It has often struck visitors to Cornwall that the churches are at a considerable distance from the towns, and that not through accident of mining settlements starting up away from villages, but old established towns, such as Callington, three miles from its parish church of Southill, Camelford, a peculiarly scandalous case, without even a chapel of ease in it ; two good miles from its church, Lanteglos, Marazion, Penzance, Falmouth, Penryn, Hayle, &c. Most of these have been rectified of late years, only Camelford is left without a religious centre in its midst. But this is a relic of a very ancient condition of affairs, when the secular and ecclesiastical tribes were distinct entities, and the *llan* was not, and could not be, in the *caer* or the *plou*. The Saxon thane liked to have his church by his house, and his priest as his chaplain, but in Celtic lands each was largely independent of the other, and the glebe is at this day the relic of the ecclesiastical territory about the *llan*, in which lived the tribesmen of the saint.

As already pointed out, the Breton bishoprics differed in constitution from those of the Breton marches, Nantes and Rennes, for each of them constituted an ecclesiastical principality, this constitution it possessed from the beginning, when the head of the little ecclesiastical state was an abbot of princely race.

So far I have spoken only of Léon, Domnomia, and Cornouaille. But the territory of Vannes was soon invaded and occupied largely by Britons, and the town alone remained in the hands of the original Gallo-Romans. A district was carved out of it in or about 465, comprising the whole seaboard from the Ellé to the peninsula of Ruis, and extending back to the heart of the great central forest of Breichen, which was entirely under the rule of British princes or counts, and this was called the Bro Weroc.

And the consequence of this occupation of the Armoric peninsula was that from the sixth century it ceased to be called other than Little Britain or Brittany, and that the ancient tongue, of which monuments remain, belonging to the Gallo-Roman domination, disappeared completely, and was replaced by the British tongue as spoken in Cornwall and Wales.

“By the middle of the sixth century,” says M. Loth, “all in the peninsula was changed—name, language, customs. This was not due to an infiltration, but to an inundation.”¹

I will now take each division of Armorica and sketch the story of the occupation of each in order. But it must be premised that the record is most incomplete, we have but the story of the saints who established their monastic settlements and lanns; but the story of the secular princes has come to us only so far as it was interwoven with that of the saints they endowed with lands, or whom they bullied. In Brittany, as in Ireland and as in Wales, the story of their relations is the same; the saints stand on a high level of influence, they are cajoled and then maltreated by the secular chiefs, who are always terribly afraid of the curses of these sacred medicine-men.

I have already said something of the settlement in Léon. It was made up mainly of colonists from Gwent, and was

¹ Loth, “L'Émigration bretonne en Armorique”

very probably an offshoot of that migration which invaded and took possession of North Devon and North Cornwall. Perhaps the earliest to arrive were a husband and his wife—their names were Glaudan and Gologwen—in a solitary coracle, which had been separated from the flotilla of which it had formed a part. They came ashore in Lesneven, near Brest, and found dense forest reaching to the shore. They searched, but it was some time before they found a habitation, occupied by a half-savage native, no doubt of Ivernian stock, who churlishly refused assistance to the new arrivals, and that although the young wife had just been confined of a boy. The husband wandered farther, lost his way in the wood, and only found his wife again at night. The child borne under such trials was S Goulven.

At the beginning of the sixth century a chief named Tudoghil, with his wife and family, his clients and serfs, arrived in one of the estuaries between which stretched north-west of the peninsula of Plou-Ediner.

Another petty chief named Romelius, with his wife Laetitia, came shortly after.

A third, called Withur, arrived with a large body of men under him and formed an organised state. He took the land from the Aber Ildut to the river of Morlaix, and founded two *plous* at least. Then he settled in the isle of Batz, from which he governed the entire tribe. To make quite sure that he should not be dispossessed or assailed by the natives he entered into relations with Chilbert, king of Paris, and secured promise of support. About 515 arrived a kinsman, Paulus Aurelianus, also from Gwent, a disciple of S Ilyd. He seems, however, to have been a native of Bovium, now Boverton, in Morganwg, then forming a portion of the kingdom of Gwent. He had been summoned by Mark Connor, a small king, to direct the spiritual affairs in his petty realm; but he did not remain there long,

in fact, only two years, and then, as the legend says, rather than become bishop, probably thinking to obtain a wider field for his energies, fled to Armorica, where he disembarked in the island of Ouessant, at a port which he named after his native place, Porz Ejennd (Port of the Oxen). His community consisted of twelve priests, twelve laymen of noble birth, nephews or cousins of the saint, all impatient to found tribes, and each taking with him wife and children, and clansmen and clients, who threw in their fortunes with their leader. Finally, they brought with them a quantity of slaves and servants. All the twelve priests were saints, and founded *llans*, and merited to have memorial chapels erected over their graves. S. Paul erected his own llan at a place in the island still called after him, Lampaul, which is the principal village of the island.

But the limits of Ouessant were too contracted for Paul's ardent spirit, and he crossed over to the mainland and founded another llan in a clearing of the forest, where remains to this day his foundation of Lampaul-Ploudalmezan. At the same time one of his lay companions, named Pedr, founded a *plou* and established himself in a fortified *caer* that still carries his name, Ker-Ber, or the castle of Peter.

But Paul could not remain quiet at this new station. After two years he was on the move again, and now he went along the north coast in an easterly direction till he reached a Plou-Meinin, a rocky land colonised by some of the clansmen of Withur, whom he resolved on visiting, partly because he could not settle in his district without his consent, and also because he was a relative. He accordingly boated over to the isle of Batz. Paul was welcomed by the count, whom he found engaged on making a copy of the Gospels. Withur, who was now very much taken up with making his peace with God, made over the

island of Batz to Paul, on condition that he went to Childebert to negotiate for him some political settlement. To this he agreed. Finally Paul settled where is now S. Pol de Léon, where he ruled as a true saint-prince over ten *trefs* or, as the monastic scribes translate them, tribes, the whole constituting one ecclesiastical principality, continuous in later times with the diocese of Léon. On the death of Withur without children his principality was absorbed into Domnonia, with the exception of that portion which Paul had claimed and received by right of kinship to the tiern or chief. The later writers of the lives of some of the saints could not understand early systems of partition of lands, and they make Paul go to Childebert and receive the episcopate whilst with him, forced on him by the king. The course of affairs was probably this. Paul, knowing well that Withur was without heirs, went to him and demanded as his right as a kinsman a large slice of his principality. Withur consented, acknowledging the right, but bade him get Childebert's consent. Paul visited Paris, and there the Frank king expressed his willingness to ratify the negotiation on condition of Paul's being made bishop over the district. Paul did not see that this was at all necessary. An abbot kept his bishops on his staff to ordain, but according to his ideas it was quite unnecessary to accumulate offices in his own hands; he might as well constitute himself his own steward. However, Childebert had been taught differently by the Latin-Frank ecclesiastics, he associated the idea of jurisdiction with episcopacy, as essential, he persisted, and Paul acquiesced reluctantly.

Again, another arrival from Gwent is to be noted, and that about the same time; this was the immigration of Carenkinal and Arthmael. The former came as secular, the latter as ecclesiastical chief. They landed, where had others, in the estuary of the Aber Ildut, and there Plou-

Arzel still bears the name of the first colony planted by Arthmael and his cousin. This remained in the hands of Carenkinal, and Arthmael went east to visit his fellow-countryman Paul, and see whether he could be useful to him, and perhaps also better himself. It is, however, possible that there may have been a quarrel between him and Carenkinal, and that the layman turned out the ecclesiastic. Such is the story as we have it, very fragmentary, of the colonisation of Lyonesse or Léon.

We will now turn to that of Domnonia, that is to say, the whole of the north coast from the river Keffleut or Morlax to the Couesnon at Pontorson, roughly speaking, of the present departments of Côtes-du-Nord and of the northern portion of Ile-et-Vilaine.

The early history is vague and legendary.

We know so much, that before 460 S. Budoc was settled as abbot of a monastery in the isle of Lauret, near that of Bréhat, and connected with it at low tides. He would not have been there unless he had powerful relatives established as secular chiefs near. He was doubtless a brother or son of one of the Domnonian princes in Britain. He is not to be confounded with his namesake, Bishop of Dol, who died in 588. In or about 460 one Fragan or Brychan, with his wife Gwen and his sons, arrived in the bay of S. Briec and settled near the river Gouet, and founded a *plou* that still bears his name. He was a native of Gwent, and his wife was grand-daughter of Aldroen or Alder, king or tern of the West Welsh settlements in Brittany. Their son, Winwaloe, they committed to S. Budoc, to be trained to become an ecclesiastical chieftain.

Another arrival was Rhiwal, from Cardiganshire, at the head of a large body of clansmen, who landed where had Fragan, and who sought to establish themselves between the Gouet and the Urne in close proximity to Fragan,

where is now S. Briec. About 485 arrived in the same harbour S. Brioc, with at least sixty persons with him in the same vessel. Brioc was probably from Ceredigion, the present Cardiganshire; the date of his arrival was about 485. Rhiwal received him favourably, and gave him land on which to settle, and when he died constituted him his successor, as they were kinsmen, consequently the whole of the colony land and tribesmen was converted into an ecclesiastical principality.

We next hear of a prince or king over Domnonia bearing the same name, possibly the same man, Hoel or Riwal, *i.e.* Rhi (the chief) Hywel, who lived between 511 and 520; but at precisely the same time we find a prince of the same name in Cornouaille. This Riwal is reported to have been son of Deroc, and to have had two brothers, Erbyn or Urbiman and Dinothus. Hoel of Cornouaille was the son of Budic I, who had been expelled from Armorica, and had taken refuge in Britain. It is possible that Budic and Deroc are the same man, and that Deroc is merely an epithet attaching to him for his churlishness.

The brother Dinothus is probably an importation from the legend of S. Ursula by the monastic compiler of the legend. In this latter, Dinothus, successor to Caradoc on the throne of Cornwall, was the father of the mythical Ursula.

Hoel Mawr, king of Cornouaille probably claimed at this time some sort of sovereignty over the northern coast of Armorica.

The next prince of Domnonia of whom we hear is again a Deroc, who is thought to have ruled from 520 to 535; he was son of Riwal. Here arises a difficulty of identification, if we assume Riwal of Domnonia to have been the same as Hoel Mawr of Cornouaille. The latter had a son, Budic II., who succeeded him, but not at once. He was

in exile in or about 510, and did not return to Armorica till 545, and he certainly was only in Cornouaille, for Canao had usurped all Domnonia and murdered Hoel II. This Deroc of Domnonia may have been chief or prince placed there by his father, Hoel Mawr, during his lifetime, on his return from Britain in 520; if so, he was the father of Hoel II. (Vychan), also known as Jonas. It is very difficult to unravel the descents of the princes of Brittany owing to their having been known by so many names or nicknames.

Under this Deroc appeared in Armorica a very remarkable man, Tugdual. His mother was Alma Pompæa, and his father Hoel Mawr. His appearance in Brittany synchronised with the recovery of his patrimony by Hoel. But he did not visit Cornouaille, but occupied himself in obtaining settlements, and founding *lanns* or *llans* throughout Domnonia from Finisterre to the Couesnon, and in the Pou Caer, that basin between the arms of high land opening to the western sea, and watered by the Aune, in which now lies the celebrated pilgrimage shrine of Huelgoet.

He seems to have demanded everywhere grants of land, and to have had these conceded to him readily by Deroc, who seems to be the same as Hoel II.,¹ who died suddenly in 549, and it was suspected that he had been murdered by his brother Canao, acting in collusion with Conmor, count or chief of Pou Caer. Canao took possession of all Cornouaille. Conmor first laid hold of Léon, and then usurped rule over the whole of Domnonia. S. Tugdual had to fly for refuge to Childebert at Paris.

To understand the rather complicated story, I must leave Domnonia and go to Cornouaille. Here we find at the

¹ By some it is supposed that Hoel II was the son of Deroc. The kings were sometimes known by their titles, sometimes by their names, at other times by their nicknames, and this makes the unravelling of the history of their succession most puzzling.

close of the fifth century a king named Gradlo Mawr, who ruled with a strong hand till about 505

In his time S. Ronan, a disciple of S. Patrick, came to the coasts. He landed in the west of Léon, at Aber-Ildut, but came south and settled in the *pou* or district of Porzoed, between Châteaulin and Quimper. He was at first coldly then favourably received by Gradlo. This Ruan is no other than the saint who has left indelible traces of his presence in Cornwall and Devon, where he is known as Ruan, Roman, and Rumon. It was perhaps not wonderful that having spent so long a time in insular Cornwall he should visit the Cornouaille, inhabited by the same people, and governed by descendants of the same princely house of Domnonia

Winwaloe also made his appearance in Cornouaille after leaving his master Budoc. He founded his great monastery of Landevennec near its northern limit, on the estuary of the Aune. But he had another Landevennec in Cornwall, and his time must have been distributed between visits to his monasteries in Cornwall and in Cornouaille. Another saint who worked in the Armorican peninsula was Tudi, a contemporary of Gradlo and Winwaloe, but of whose life no continuous record remains. There was again another, S. Corentin, regarded as the first bishop of Quimper, but a bishop at that time, and among the British, implied something very different from what was supposed by the late writer who compiled his Life. He also was a founder in Cornwall of the church of Cury.

Another, S. Day, was a founder of churches in both Cornwalls.

The early history of the kings of Brittany is peculiarly difficult of elucidation. The first named is Hoel or Riwalin Maccon, or King Hoel the Great, son of Conan, and he is assumed to have been the son of the some-

what mythical Cynan Meiriadog. On his death his brother, Urbian or Erbyn Concaer, succeeded, but it is not clear whether they ruled over Domnonia or over Cornouaille, or over both together. The son of Erbyn was Selyf or Solomon, surnamed Gweddol, or "the Handsome." He fell in battle against his own subjects about 434, and is esteemed a martyr. Here we are constrained to notice the identity of family names of the ruling house in Cornouaille and that in Cornwall. In both we have Howels, Erbyns, and Solomons, and I think, that when we put this together with the fact of the saints of both Cornwalls being the same, and the people of both calling themselves Cernau, that we must conclude that Armorican Cornouaille was a colony from Cornwall, and had nothing to do with the Cornavii of Shropshire.

The next name comes to us from the Welsh genealogies ; it is that of Cynfor. He is not named in Brittany as having reigned, and if he were, as is probable, the son of Solomon, then after the death of his father he fled to Britain. His son, however, Aldor, Aldroen, or Audrian, is a man who has been laid hold of by that romancer Geoffrey of Monmouth. He is known alike to Welsh and to Breton chroniclers. At some time, probably about 510, he had to return to Britain, whether to escape from an insurrection, or merely to look after his affairs in Cornwall, we do not know. The brother of Aldor was Constantine, surnamed Gorneu, or "the Cornishman," but also known in Welsh pedigrees as Constantine Llydaw, or "the Armorican," and also as Bendigaid, or "the Blessed." The time of his assumption of the Domnonian throne in West Wales was 433, just about the time of the death of Solomon I. Aldor's eldest son is known to the Welsh as Emyr Llydaw, or "the Armorican," but he seems to have been driven into banishment, for he was for some years in Wales, in Morganwg

apparently, as his sons married the daughters of Mewrig, king of that country. At the same time there was another refugee in Wales from Brittany, Budic I. of Cornouaille, son of Daniel, son of Ian Reith, who founded the dynasty.

Budic settled in Carmarthenshire, and one of his sons, accidentally killed, is buried at Llandeilo. According to Welsh accounts, his sister, Rhian, became the mother of S. Illtyd. After the restoration of Budic, in 490, S Teilo visited him, and founded *lanms* in his territories. Another sister of Budic was Gwen Teirbron, who married Æneas Llydewig, and by him became the mother of S Cadfan. Her second husband was Fragan, of whom we have already heard, and to him she bore S Winwaloe.

Budic died about 509, leaving several sons—Hoel I, Melyan, Oudoc, Ishmael, and Tewdric. The territory was, after the usual manner with Celts, divided among the sons, Oudoc and Ishmael excepted, for the former of these had become a devoted disciple of S. Teilo, and Ishmael of S. David.

According to the Welsh accounts, Budic had lived in Dyfed when driven from his principality till the death of the usurper, who may have been, and probably was, Gradlo. A child of his, Tyfei, had been accidentally killed near Llandeilo, and the pretty little church of Llandefisant, in the park of Lord Dynevor, commemorates his name, and stands over his grave.

Tewdric became prince in Cornwall, and Hoel and Melyan divided the Brittany principality between them. But that happened in Armorica which was of constant recurrence in Wales, one brother desired to get hold of the share of the other. Melyan reigned for seven years, from 530 to 537, and was then treacherously stabbed by Hoel.

Melyan, by his wife Aurelia, had left a son, Mellor, who was obliged to take refuge, first in one place, then another,

from his uncle, who, however, first mutilated him and then killed him. He died shortly after this, and this sudden death was regarded as due to the vengeance of Heaven for the double crime.

The death of Hoel left Armorica to be fought for between his grandsons. But of these, two, S. Tugdual and S. Leonore, had embraced the religious life, and would be content with the very ample endowments in Domnonia, but the others, Hoel II., Vychan, also called Jonas, Canao, Erc or Gwerch, and Macliau, chose their shares of the secular inheritance. Budic II. was at this time *hern*, prince of Cornouaille. His relationship to the brothers is not very certain. He was married to a sister of S. Teilo, so that he had been in Wales with Budic I., and was probably his son.¹

Canao was an ambitious man, and he proceeded to murder those of his brothers whom he could get into his hands—Hoel Vychan and Erc. This was in 546. Hoel, his brother, had been married to a daughter of Maelgwn Gwynedd. Canao not only murdered his brother, but at once took to him the widow, his sister-in-law. Macliau would have fallen a prey as well, but that he fled for refuge to Conmor, count of Bro-Weroc, and when Canao pursued him there he fled farther to Vannes, where he took orders, and was promoted to be bishop. But he also was an ambitious man. Budic II had entrusted his young son, Tewdric, to his care. Macliau drove him into exile, and seized on all Cornouaille except Pou Caer, where Conmor was too powerful for him to touch, and ruled it along with his diocese of Vannes. Hoel Vychan had left a son, Judual, who fled for his life and took refuge at the court

¹ It is very difficult to be at all sure of the descents. M. de la Borderie makes Machan and Canao sons of Gwerch I. But Hoel Vychan was their brother. I attempt to give only a conjectural pedigree.

of Childebert. Incensed at this, Canao had the indiscretion in 559 to give asylum to Chram, the revolted son of Clothair. This induced the Frank king to invade Brittany. Canao was killed in 560, and the prince, Chram, was overtaken on the shore, where he was endeavouring to carry off his wife and daughters in a boat. The remorseless father had his son strangled, and the wife and daughters burnt alive.

Conmor had extended his power over Domnonia, and had taken to wife Trifina, daughter of a former Gwerch or Erc, count of Bro-Weroc, on the British portion of the territory of Vannes, in the hopes of extending his possessions in that direction; but for some unknown reason, in a fit of disgust, he drove Trifina away, and she ended her days in a religious house. It was long after fabled that he had killed her, and that she had been resuscitated by S. Gildas. The pride, the tyranny of Conmor had raised him a host of enemies. Judual, the claimant of the throne, was at the Frank court.

Samson, son of Amwn the Black, and grandson of Emyr Llydaw, had been brought up in Wales. Amwn desired to return to his native land, and in company with his son Samson started for Armorica. They crossed Cornwall Amwn, worn out with age, was left behind, but Samson waited his opportunity and crossed to the mainland attended by a large body of monks and fighting men. He planted himself at Dol. About the same time S. Malo, a son of Derwela, sister of Amwn the Black, and therefore cousin of Samson, settled near by at Aleth, at the head of another large body of men, partly ecclesiastical and partly military. In fact, a host of adventurers, seeking a country to conquer and appropriate, had joined these saints, who asserted that they were going against an upstart who had robbed them of their patrimony. With Samson was another

first cousin, Maglorius. Connor heard of their arrival with dissatisfaction, but they had made as yet no signs of active hostility, and had posed as holy men seeking solitude, and he therefore did not venture on attacking them.

Samson now slipped away, and went to Paris after Judual. He besought Childebert to allow Judual to return to Armorica, and by force of arms recover his principality. The Frank king hesitated for a while, but at length consented. Thereupon Samson conveyed Judual into the Channel Islands, where they tarried awhile to concert measures and to drill a body of recruits. Meanwhile Malo and Maglorius and the disciple Mewan were acting on the minds of the people of Domnonia, exciting them to revolt. When all was ready, Samson and Judual crossed over, mustered their forces, and marched against Connor. Three hardly contested battles were fought, and in the last Judual ran the usurper through with a javelin. Thus ended Connor in 555. He had been a benefactor to the Church; like other British chiefs he endeavoured to conciliate the saints to bless him and curse his enemies, but he had too many saints allied by blood to those whom he had supplanted to be able to maintain himself in the odour of sanctity, and he has gone down in tradition as a monster, and as the accursed of Heaven.

Judual was grateful to Samson for the assistance given to him, and made him many territorial concessions. He died in 580, leaving five sons, of whom the eldest, Juthael or Hoel III., succeeded him in Domnonia. Haeloc or Alan was made count of Cornouaille. Of Juthael nothing is known but his marriage with Pritella, daughter of Ausoc, a petty chief of Kemenet Illi, that is, a district in Léon or Finisterre running inland from Landillis to Landerneau. It had been colonised, probably from Gwent, by some saint named Illi or Ilhdrius, of whom nothing has been

recorded. The curious part of the story is that Taliesin was then visiting Domnonia, and his advice was sought in the matter of the marriage. Judicael died in or about 605, and left several sons. Juthael was the eldest, his next brother was Judoc, then came Haeloc or Alan.

Judicael was a feeble, amiable personage, very unfit to rule, and at once his ambitious brother, Haeloc (Alan II.), supported by his foster-father, Rethwal, resolved on seizing on the throne. Judicael was able to save his life only by escaping into a monastery, and being shorn as a monk. Seven brothers were murdered, one a mere child. Some years later, 610 or 615, Haeloc was seized with compunction for his crimes, converted by the words of S. Malo, and he surrendered the crown he had usurped to Judicael, who at once issued from the monastery in which he had been hiding, and took to himself a wife. He entered into an alliance with Dagobert, and formed a warm attachment for S. Elgus and S. Ouen. In or about 640 Judicael resigned his crown; he had spent so much of his days in the monastery, that he pined to return to its quietude. His brother Judoc refused the crown, and it was taken by Solomon II. Whether S. Winnoc were a brother or a nephew is uncertain. He died in 717, but it is said at a very advanced age.

To return to Cornouaille. Budic II had married Anau-med, sister of S. Teilo, whilst he was in exile in Dyfed. The Bretons say that he was a son of Cybydan, descended from a colonist Ian Reith (Righteous Law), but he was clearly closely akin to Hoel I., and when Budoc was settled into his principality, S. Teilo came there to visit him, and S. Samson met him and took him back with him to Dol, where Teilo planted an immense orchard of apple-trees, with grafts brought by him from Wales. This orchard was called in the twelfth century "*Les Vergers de Tielo et de*

Samson" It was on this visit to Brittany that Teilo summoned his nephew Oudoc to accompany him back to Wales to enter the religious life. Another visitor was Gildas, who has left numerous traces of his presence, and whose tomb is shown at S. Gildas, near Carnoel, in Pou Caer. As already said, Macliau, bishop of Vannes, had driven away Tewdric, son of Budoc, prince of Cornouaille, but in 577 Tewdric returned, gathered an army, fought the bishop, and killed him and one of his sons. The other son, Erc or Gwerch II., retained his hold over Bro-Weroc, and he was not able to dispossess him. This Gwerch II. was one of the ablest and most heroic princes of whose exploits against the Franks record has been preserved. Tewdric died about 586. Nothing further is known of him, and with him ends the record of the princes of Cornouaille.

But long before this S. Cadoc had appeared in Armorica ; he was one of the most restless of the Celtic saints. Unhappily his Life was not written till five or six centuries after his time ; but although thus lacking in historical accuracy, it retains many features of great interest that were clearly derived from earlier texts. He had visited Ireland, Italy, and, if we may trust the legend, even Greece and Jerusalem. He has left his trace in Cornwall as well as in Wales. He went to Brittany to visit S. Gildas, and he landed with a number of followers on an island in the great bay or inlet of Etel, near Beltz, in the Morbihan. There for a while he settled, and the islet bears his name to the present day. He built a causeway from the islet to the mainland, then his restlessness came on him again, and surrendering the conduct of the monks to a disciple, Cadwalader, he returned to Britan.

About 585 arrived a virgin named Ninnoc, at the head of a swarm. She was a daughter of one Brychan and

his wife Meneduc, but not of the famous Brychan of Brecknock. She had been baptized by S. Columba, and instructed by an Irish bishop of the name of Gorman. The fancy came on her to found a colony, and being of royal blood, she was able to attract to her a large body of adventurers, among them four bishops, a host of priests, monks, virgins, and of non-professional saints enough to fill seven large vessels. A chaperon to the damsel, a married man, Gurkentelu Ilfin, and his wife, Gwenargant, were engaged, whose duty it was to keep order among this mixed multitude.

The seven ships came ashore at the mouth of the Laita, that formed the confines between Cornouaille and Bro-Weroc. The lagoon took the name of Pyl Ilfin, and the inlet was entitled the Lake of Lan-nennoc, from the double settlement planted by the princess on the shore. Nennoc established herself as abbess over a double community, one of men, the other of women, precisely like that of S. Bridget in Ireland, and of several that sprung up in Northumbria under the direction of the great missionaries from Iona. In fact, Ninnoc in Cornouaille was the counterpart of S. Hilda in Northumbria. A church was constructed in the midst, and the brethren set to work to build little huts for themselves and the sisters around. Nennoc took supreme control, but Gurkentelu was set to keep order among the men. The writer of the Life of S. Nennoc says that in his day the ruins of this curious agglomeration of separate cells remained. Such a double monastery was so inconsistent with the ideas of his time, and the attempt to revive the institution by Robert of Arbrissel had led to such scandals, that the writer cannot have invented the story, and knowing what we do of the usages of the Celtic Church, we are aware that this was in strict conformity with them. It is singular that the author

of this Life has nothing more positive to say about S. Nennoc after the construction of this double monastery. No record remained of how it had flourished or gone to pieces.

At Dol, Samson was succeeded by his cousin, Maglorius, who speedily resigned and was followed by Budoc, who was abbot or head of the ecclesiastical tribe till about 588. Then came Leucher, of whom nothing is known, and he was followed by Tighernomalus, who had the Life of S. Samson written and dedicated to him. It is deserving of remark here how closely connected with the names of these Breton princes and saints are some of those found on the Cornish inscribed stones. At Madron is a stone to Rivalus, son of Bran Cunovalus; at S. Cubert is one to Conetoc, son of Tighernomalus; at Endellion is a stone to Broegan, which is the name of the father of S. Nennoc. Add to this the fact that the large majority of the saints of Cornwall are saints also of Brittany, and I think that the intimate relationship between Armorica, Cornouaille, and Domnonia, and insular Cornwall and Devon, becomes almost certain, and that the conjecture of M. le Moyne de la Borderie that Cornouaille was occupied by Cornavii from near Newcastle, or even by those from Shropshire, resolves itself into a phantom of the brain.

At Aleth, S. Malo was succeeded by S. Gurval, who is supposed to be the same as S. Gudval. There is, however, a difficulty in the identification, as one does not see how the *r* was changed into *d*. Gurval is said to have remained at the head of the establishment but a short time and then to have retired into the forest of Breichen, and to have settled as a hermit at Guer, where he founded his *llan*. Gudval is said to have come from Britain, *Britanniæ finibus*, and he founded a monastery at Loc-Goal, near that of S. Cadoc, near the lagoon of Etel. There a mound is still

pointed out on which he lived, and there also is his fountain, and there also a chapel dedicated to S Bridget, and near it an inscribed stone bearing the name IAGV.

Another colonist was S. Ternan, whom the Bretons call Tenenan. He was from Britain, probably from Gwent or Morganwg, and he was great-nephew to S. Paul of Léon. It was therefore quite what might have been expected that the kinship should receive recognition, and that he should be elected ecclesiastical chief of the ecclesiastical settlement at Léon, about 596, and he died about 623.

The last immigrant was S. Ywy, a disciple of S. Cuthbert, an enthusiastic adherent of Celtic peculiarities, and when these were giving way in Northumbria he went to Armorica, where he hoped to practise them without molestation. He founded a good many *llans*; but we have only a meagre sketch of his life and labours. For some time the history of Brittany becomes most obscure; a few names come up, but none of consequence till about 824, when a man of remarkable force of character and original genius appears on the scene.

This is Nomnoe, whom the hostility of some of the monastic writers has induced to depreciate as having been raised from the plough tail to be a duke and king. This is most improbable. He probably descended from the royal house, but from that when reduced to its lowest condition of powerlessness.

It is unnecessary to detail his history here.

Made Governor or Duke of Brittany by Lous the Pious, he remained faithful to that feeble prince so long as he lived; but when the empire broke up with the death of Lous in 840, he resolved on making his country independent. He had for some time been preparing his measures. In one Convoyon, a humble monk, he recognised both daring and patriotism, and he supported him against the nobles about

Redon, where Convoyon had settled, even against the bishop, and further even against the royal authority invoked to crush him. Convoyon, won by the zeal wherewith Nominoe took up his cause, and sharing in his ambition, was prepared to act in concert with him, and that heartily. Nominoe succeeded in annexing both Rennes and Nantes to Brittany, and in establishing the independence of the peninsula. Then he turned his attention to ecclesiastical affairs. Some of the bishops were Franks thrust into the Breton sees, and more or less tainted with simony. Nominoe, on the accusation of Convoyon, summoned them to give an account of themselves, and he sent them to the Pope, and demanded their deposition. But he became impatient at the tortuous and grasping methods of the Roman court, and he summoned a council in his own land, and called the bishops before it; they acknowledged their guilt, and laid down their staves and rings in token of surrender.

Nominoe now increased the number of sees, appointed hearty Breton-minded men to them, and elevated Dol to be the primatial, archiepiscopal see at the head of all the rest in Brittany proper.

Nominoe advanced into France, defeated Charles the Bald in Anjou, and had got as far as Vendôme when he was carried off by sickness in 851.

He left a son, Erispoe, who succeeded him, but his elder brother, Rhiwal, had a son named Solomon, who resented his exclusion from the throne. Erispoe agreed to become the vassal of Charles for Maine and Anjou. Perhaps this did not please the Bretons, for an insurrection broke out, headed by Solomon. Erispoe was obliged to fly for refuge to a church, and there Solomon killed his uncle at the altar, in 867.

Solomon was now sole king of Brittany, but after some time he committed the indiscretion of resigning the crown

to his son Wigo. This was in 857, when he was old and weary of government. This at once excited the ambition of Pasquien, count of Vannes, who had married the daughter of the murdered Erispoe. He raised the standard of revolt Wigo was taken and killed; Solomon fled for refuge to a monastery, but was induced to leave it, and was put to death by his eyes being put out with red-hot irons in so barbarous a manner that he survived it only two days.

It has been supposed by some that this Solomon is the saint of the name who is venerated in Brittany, and undoubtedly the two have popularly been confounded; but Solomon the saint was known and esteemed holy in Cornwall as well as in Brittany, and in the tenth century there existed no such connection between the countries as could explain this usurper and murderer having been in Cornwall and there founded churches. Solomon who is saint in both countries belongs to the fifth century

Let us now take a glance at the ecclesiastical organisation in Brittany for three centuries

It has been already pointed out that a settler on coming to Armorica established his colony as a *plou* or *plebs* or tribe Each head of a household was granted a *tref*, that is to say, a habitation with land around it. In Cornwall the thousands of *trefs* indicate such settlements, but there the title *plou* has been lost, as several plous coalesced. They coalesced also in Brittany, and became *pous* or *pagi* or regions. In Domnonia there were six of these—Pou-Castel, Pou-Goelo, Pou-Tregher, Pou-Penteur, Pou-Dour, and Pou-Racter. In Cornwall the ancient *pagi* are represented by the deaneries, in Wales by the cantrefs

When the religion of the new colony came to be set in order, then the secular princes gave up land here and there to the saints on which to establish a llan or a monastery.

The llan was usually only a church with some land about it, glebe, for the maintenance of a disciple of the saint, a priest to minister to the people; and as already said, the llan was very often not at all close to the secular settlement, as each tribe, secular and religious, lived apart on their own lands under their several chiefs

The ecclesiastical settlements were not solely monastic. There was a monastic core to each, with the abbot and his disciples as heart and ruling power, but there were under him bishops and priests and deacons, not monks, who might be married men, and very often were so, and in Wales so they remained down to the twelfth century. Sometimes, by no means always, the authority as chief of the tribe was united to that of bishop; but this was arbitrary only, and it did not enter into the ideas of an early Christian Celt that a bishop ruled by Divine commission; he regarded him as the official retained by the ecclesiastical chief to propagate the sacred orders. There were many bishops, for by a curious misunderstanding of the rule that three bishops should unite in every consecration, the Celtic consecrator always ordained three bishops at a time, and single or double consecrations were regarded as irregular, if not unlawful.

With respect to the married priests, there remains a curious letter addressed by the three bishops of Tours, Angers, and Rennes to two priests of the Britons, reproaching them for irregularities committed within the confines of the diocese of Rennes between 512 and 520. It must be premised that just as the Britons had encroached on and occupied a large portion of the territory of Vannes, so that bishop Regalis there complained of being enveloped by them, so had they encroached on the territory of the ancient Redones, and had occupied the whole upper portion of the country from the sea; in fact, had taken posses-

sion, ecclesiastically and civilly, of a portion of the county and diocese of Rennes. Very naturally the settlers liked to be ministered to by their own clergy, in their own tongue, and according to their traditional usages. This drew forth a letter from the three bishops, Licinius, Eustochius, and Melanius, to the priests Lovocat and Cathern. They said that it had been told them by a priest, Sparatus, that they not only had female companions living with them (*con hospite*), but that they even allowed these women to minister the cup in communion. They therefore warned them, and supplicated them to desist from these abuses.¹

We can by no means be sure that Sparatus told the whole truth, that, in fact, he did not exaggerate in the matter of the administration of the chalice. What he heard, no doubt, was that these priests lived with their wives, and the great rub was that they were acting and ministering in the diocese of Rennes without leave of the bishop, and without any idea that any licence was necessary when ministering to their fellow-Britons.

We find nowhere else any trace of the Celtic clergy allowing women to act as deaconesses at the altar, but we do find that they claimed the right to be married; and indeed Sulien, one of the most notable of the bishops of S. Davids, who ruled from 1071 to 1076, and again from 1078 for ten years, was a married man, the father of four sons. From 1076 to 1078 the see was occupied by Abraham, who set up a monument to his two sons. Rhydfarch, son of Sulien, succeeded his father in 1089, and was himself a married man. But it was so also in the Anglo-Saxon Church; the canonries were held by married men, till Dunstan swept them out and planted celibates in their room.

It was so also in Brittany. Macliau, Bishop of Vannes, was married, and in spite of the condemnation

¹ Duchesne. "Lovocat et Catherne," in *Revue de Bretagne*, 1885

of the Franko-Gallic bishops, continued to live with his wife. A certain Tetbald, son of a priest named Loscoran, was elevated to be bishop, and married the daughter of the Archdeacon of Nantes. When old, Tetbald resigned the see to his son Walter, who became bishop in turn, and Tetbald took the abbacy of S Melanius. No doubt these were scandals, but only possible because the prevailing idea in the Celtic Church was not in favour of celibacy.

We must look on the Celtic abbey as the head of the district or province or *pou*; under it were numerous clergy not monks, who were sent to minister in the several churches, and many lay colonists who were granted farms, as also serfs who worked under them.

A monastery whether in Wales, Ireland, Scotland, or Brittany had the same character; it was surrounded with an embankment or wall, and within, of wood usually, were the church and the refectory and the kitchen. Each monk occupied a separate cell, that is to say, a circular hut of stone or of wood with conical roof. On a mound or in a commanding elevation was the bee-hive hut of the abbot.

In the island of Lauret, near Bréhat, off the Brittany coast, are remains of the monastery of S. Budoc.¹ It consists of the ruins of an old church with its sacristy; of a much later church of SS. Simon and Jude, characteristically dedicated to apostles "known of all men," and not to any of the saints who lived and laboured and died on the spot; also of a cemetery in which the old solitaires were laid; and of eight circular huts, five of which are ranged in a row, all but one of which are ruinous, but one remains intact. There were formerly many more, but as the whole area of the island has been tilled, only a few have escaped demolition.

On another isle in the same archipelago, the Isle Modez,

¹ Plan and map are given in De la Borderie's *Hist de la Bretagne*, vol. 1, 2896.

is the bee-hive hut in two stages, believed to have been the abbatial cell of S Maudez or Mawes

It is solely on islands and in remote spots, as also where wood was scarce and stone plentiful, that such relics remain, elsewhere they have disappeared.

Outside the enclosing rampart were the lay folk, and in many monasteries no woman was suffered to set foot within the enclosure.

The monks were the educators of the young men of the *plou*. These were sent to them to be instructed in religion and in literature

The life of the monks was one of great severity From the Life of S Brioc we have a sketch of the services. "At fixed hours they all assembled in the church to celebrate divine worship. After the office of vespers (at 6 P M) they refreshed their bodies by a common meal Then, having said compline, they dispersed in silence to their beds At midnight they rose and assembled to sing devoutly psalms and hymns to the glory of God. Then they returned to their beds. But at cock-crow, at the sound of the bell, they sprang from their couches to sing lauds From the conclusion of this office to the second hour (8 A.M) they were engaged in spiritual exercises and prayer. Then they cheerfully betook them to manual labour."

Some enthusiastic solitaires lived apart in cells in the woods or on the moors called "deserts," and only occasionally joined in the worship of the monastic choir. Some in their fervour delighted in plunging themselves to the neck in water to recite their midnight psalms S Meven one night was passing to his cell when he heard a gurgling voice and chatter of teeth—it was mid-winter as well as midnight—and he went to the river side to discover the cause of the noise, when he found there his disciple S. Judicael, with teeth chattering with cold, muttering his orisons

The food of the monks was scanty, one good meal a day, and that in the evening, was all, and yet in some monasteries they were allowed a fortifying soup in the morning as breakfast. They ate bread, eggs, fish, seal, and porpoise; honey was allowed, also beer, and cheese was a condiment to their bread. In the Life of S. Sampson we hear of their having some cordials supplied. "It was customary (at Llaniltyd) to squeeze out the juice of certain herbs cultivated in the garden of the monastery, and to mix this with the drink of the monks, by pressing it through a little pipe into the mug of each, so that on returning from singing terce (9 A.M.) they all had this mixture served them by the butler."

From this centre the whole ecclesiastical government of the tribe proceeded. There were *llans* and *locs*, or churches and chapels, to be provided with clergy, and to this the abbot saw; and each llan or loc stood in its own glebe, with about it sufficient estate to maintain the ministering clerk.

Terrible was the vengeance of the abbot on such daring tierns as ventured to encroach on the property of his monastery. The cartularies of the monasteries, the legends of the saints, are heaped up with examples of the horrible deaths of such as invaded the lands of the Church, or carried away the cattle of the saints. One might almost suppose that the main solicitude of these abbots was to accumulate and preserve landed property and live stock; but it must be remembered that many of the grants of repentant princes and desecrators of the sacred rights are mediæval forgeries, composed at a time when the greed after land was an engrossing passion in the hearts of monks, and also, that it was a necessity of the time and conditions of social and political organisation for the abbots to have their patches of glebe everywhere, and that for the sake of the souls of the poor they were compelled to do battle for the bits of land on which their churches stood.

We have preserved to us a form of cursing employed by the church of Aleth against such as invaded its property. It is found in a MS. of the end of the eighth or beginning of the ninth century, but is doubtless older.

After a warning to the wrongdoers to withdraw and make amends, the abbot-bishop proceeds against the violators.—

“If they do not hasten to make amends and give that satisfaction to our mediocrity which they have offended, then we smite them with eternal malediction, and by a perpetual anathema.

“May the wrath of the Sovereign Judge fall on them. May they lose all right in the heritage of God and of His elect.

“May they be excluded in this world from the communion of the faithful, and in the world to come from that of God and of His saints.

“May the devil and his angels be their companions, and the torments of the avenging flame and eternal sobbing be their lot.

“May they be held in execration in heaven and earth, and when this life is ended, become the prey to the anguish of hell

“Cursed be they in their houses, and cursed in their fields, cursed in their food, and cursed be the fruit of their bellies. Cursed be all that they possess, from the barking dog to the crowing cock. May theirs be the destiny of Dathan and Abirom, whom hell swallowed up alive; that of Ananias and Sapphira, who having lied to the Apostles perished on the spot; that also of Pilate, and of Judas who betrayed his Lord.

“May they have but the burial of an ass, and may their light be put out in darkness.”

To superstitious, half-civilised Celts such curses pronounced by the successors to the Druids and medicine-

men whom their forefathers had revered from time immemorial produced the greatest effect. They quailed before them, and rarely did these curses fail in their effect. A chief who braved them trembled with fear if he caught a cold, sprained a joint, fell from his horse—he thought the anathema was beginning to work. The greatest monsters, murderers of brothers and usurpers, cringed to the saints, and bought their benediction by grant of lands.

In the study of the history of the Church among Celtic peoples the records of the colonisation of Armorica from Britain are of great importance, as they show us the procedure which doubtless was followed everywhere else, and which indeed was that adopted by the Brythons when they first came into Britain, and when they were pagan. Then, also, we can hardly doubt the Druids were accorded their glebes on which to settle, and then also the people was divided into secular and sacerdotal tribes.

What we find in Christian Cornwall, Wales and Brittany was but the adaptation to a new religion of an organisation of hoar antiquity.

So far we have seen how Brittany was occupied from Devon and Cornwall and Wales, perhaps also from other parts of Britain, but there can be little doubt that there were also settlements on its coast from Ireland. We know from the Cambrian Annals that the Welsh coasts were infested by Goidel Picts, and Welsh history records occupations of Gwynedd, of Pembroke, Carmarthen, and Brecknock, by these invaders. In Cornwall also they took possession of the Land's End district. It would have been strange had they not also made descents on the Armorican sea-board. When we find, as we do, in Brittany, that the cult of such a purely Irish saint as S. Bridget is widely extended, and that Kieran of Saigr is there found as Kerian, the Goidelic form of his name, as well as under the

Brythonic form of Peran, we may be confident that there was an Irish element in the population as well as one that was British S Brendan, S Senan of Inniscathy, S Tighernac, to whom S Bridget stood sponsor, have all left their mark in Brittany, and Breton tradition gives an Irish origin to several of their local saints The presence of saints of one nationality in a district very generally implies that they followed their countrymen, who had come without pacific or evangelising intent They attended on them, much as missionaries now go in the track of colonists of their own race and tongue.

PEDIGREES OF SAINTLY FAMILIES.

CONTENTS

	PAGE
I. THE HOLY FAMILY (<i>conjectural</i>) . . .	123
ROMAN.	
II. THE FLAVIAN FAMILY	124
III. FAMILY OF CONSTANTINE THE GREAT	125
IV. FAMILY OF THEODOSIUS THE GREAT	126
GREEK.	
V. FAMILY OF S. BASIL and S. GREGORY OF NYSSA	127
GALLO-ROMAN.	
VI. FAMILY OF S. SIDONIUS APOLLINARIS	127
BRITISH.	
VII. FAMILY OF CUNEDDA, fugitives from North Britain	128
VIII. FAMILY OF BRYCHAN, Goidelic conqueror	129
IX. Table Illustrative of the GWENT-BRECKON SAINTS who settled in north-west Cornwall	130
X. FAMILY OF LLYR MERINI and CARADOG FREICHFRAS	131
XI. FAMILY OF CAW, fugitive from North Britain	132
XII. FAMILY OF GERAINT, Prince of Devon	133
XIII. FAMILY OF S DAVID	134
XIV. FAMILY OF S. GWYNLLYW, S CADOC, and S PETROC	135

	PAGE
XV FAMILY OF COEL GODEBOG, of SS DEINIOL and ASAPH	136
XVI. FAMILY OF ARMORICAN FUGITIVES, S SAMSON and S. PADARN	137

BRITTANY.

XVII FAMILY OF S. MELOR, and SS JUDICÆL and WINNOC (<i>conjectural</i>)	138
XVIII. FAMILY OF S. POL DE LÉON	139

FRANK and BURGUNDIAN.

XXIX TABLE OF MEROVINGIAN KINGS	140-41
XX TABLE OF DESCENDANTS OF CHILPERIC I	142-43
XXI. TABLE OF BURGUNDIAN KINGS	144
XXII FAMILY OF S ARNOALD	145
XXIII FAMILY OF S. AMALBERGA	145
XXIV FAMILY OF CHARLEMAGNE	146-47
XXV FAMILY OF S. GREGORY OF TOURS	148
XXVI FAMILY OF S. GERTRUDE OF HAMAGE	149
XXVII. FAMILY OF S. GERTRUDE OF NIVELLES	150
XXVIII FAMILY OF S. WALTRUDE	151
XXIX. FAMILY OF S. ODILIA	152

ANGLO-SAXON.

XXX. FAMILY OF THE KINGS OF KENT	153
XXXI FAMILY OF THE NORTHUMBRIAN KINGS (Bernician)	154
XXXII. FAMILY OF THE NORTHUMBRIAN KINGS (Deirian)	155
XXXIII FAMILY OF THE KINGS OF MERCIA	156-57
XXXIV FAMILY OF THE KINGS OF EAST ANGLIA	156-57
XXXV FAMILY OF THE KINGS OF WESSEX	158

ROMAN.

II.—PEDIGREE OF THE FLAVIAN FAMILY (*after De Rossi, Bullett. 1865*)

Several points cannot be determined with certainty. It has been supposed by some that Pope S Clement was the son of a third son of Tl Fl. Sabinus, who died 69, but this is mere conjecture.

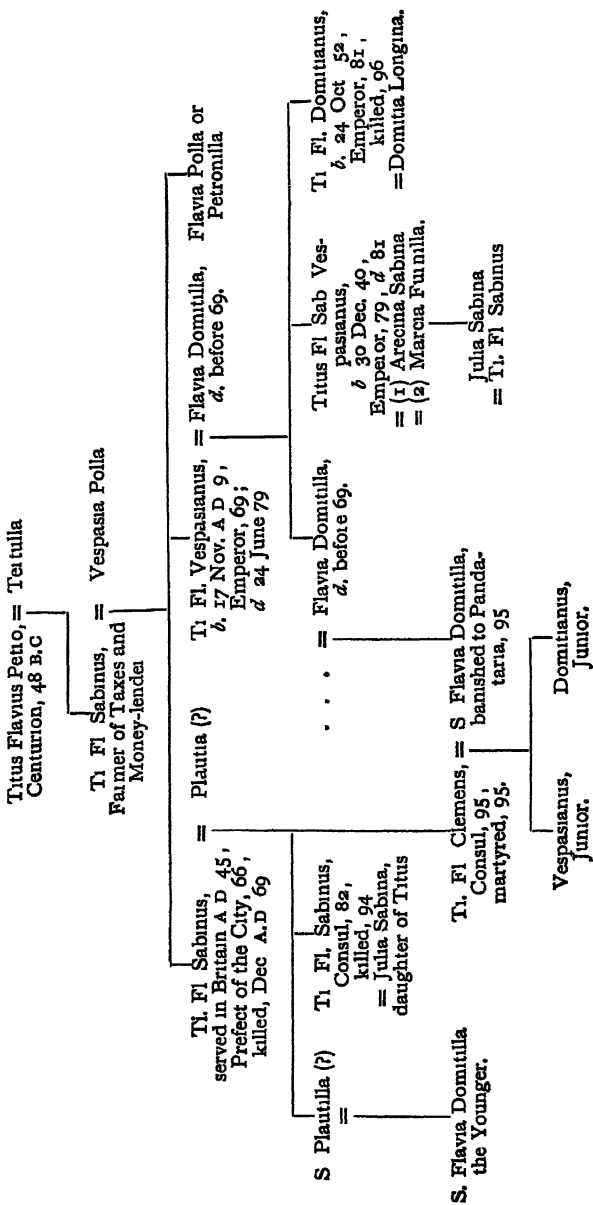

IV.—FAMILY OF THEODOSIUS THE GREAT.

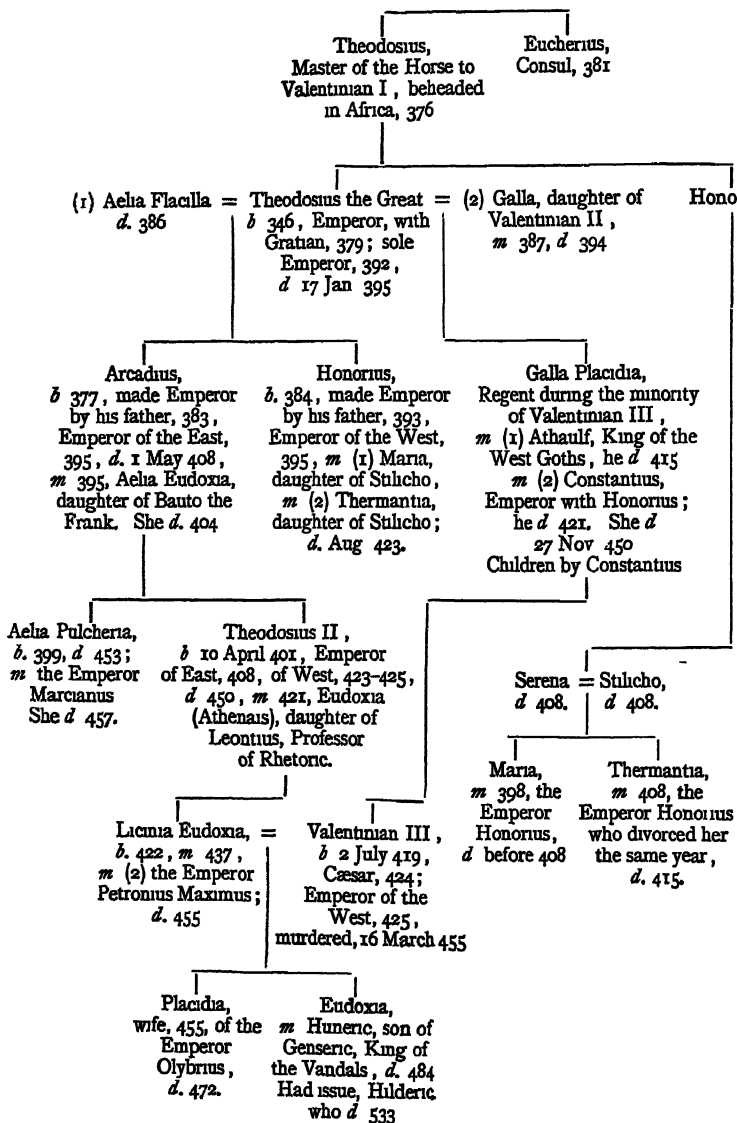

GREEK.

V.—FAMILY OF S. BASIL AND S. GREGORY
OF NYSSA

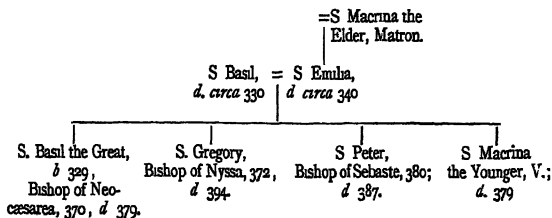

GALLO-ROMAN.

VI.—FAMILY OF S SIDONIUS APOLLINARIS.

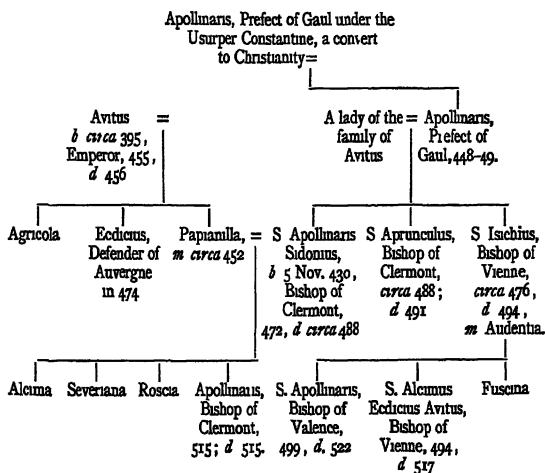

Avitus, Archdeacon of Clermont in 560, belongs to the family,
but where to be placed is uncertain.

BRITISH.

VII.—FAMILY OF CUNEDDA (ONE OF THE THREE HOLY FAMILIES OF BRITAIN).

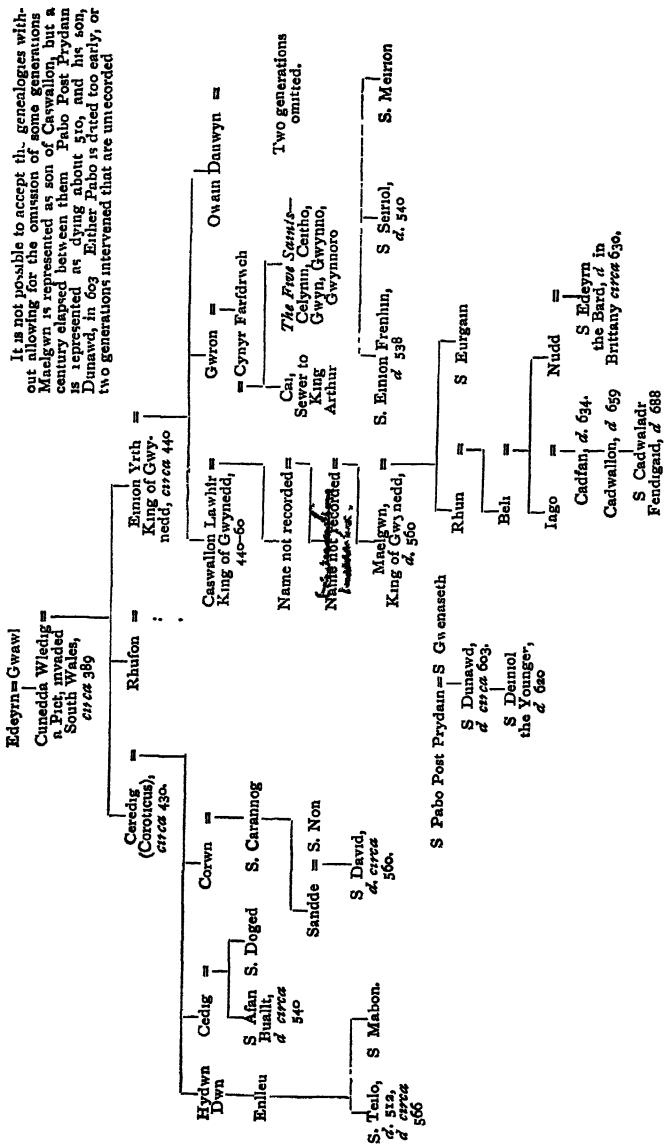

It is not possible to accept the genealogies without allowing for the omission of some generations. Maelgwn is represented as son of Caswallon, but a century elapsed between them. Pabo Post Prydain is represented as dying about 510, and his son, Dunawd, in 603. Either Pabo is dated too early, or two generations intervened that are unrecorded.

VIII.—FAMILY OF BRYCHAN (sons chiefly. ONE OF THE THREE HOLY FAMILIES OF BRITAIN'.

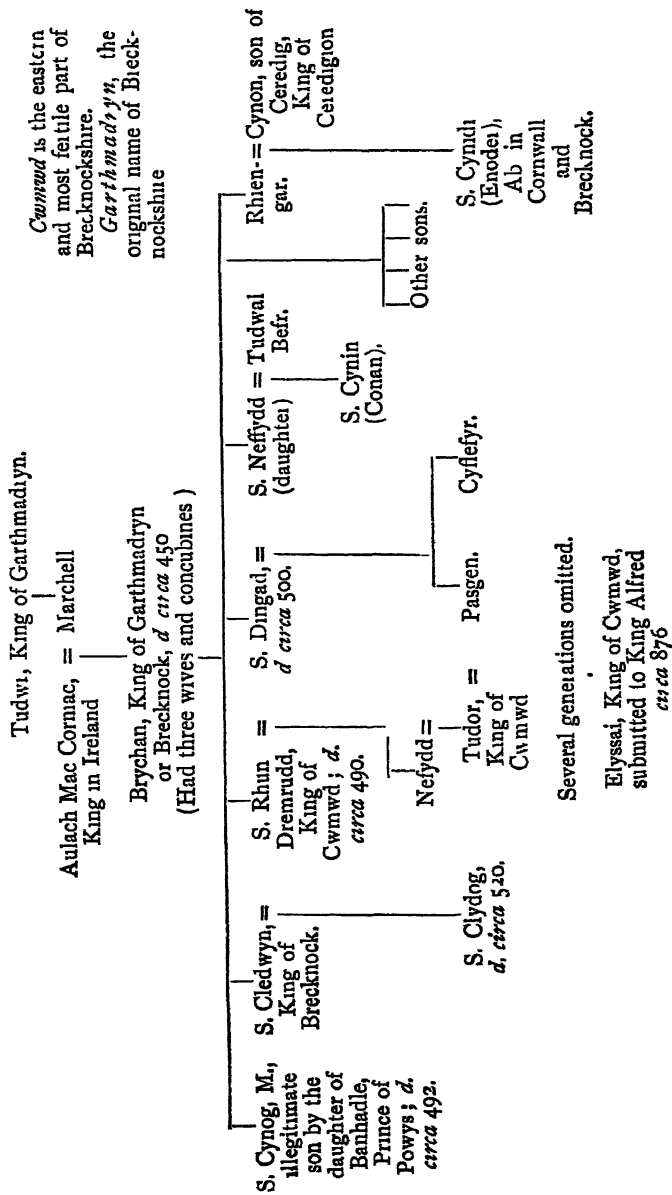

IX.—TABLE ILLUSTRATING THE RELATIONSHIPS OF THE WELSH-IRISH
SAINTS SETTLED IN NORTH-EAST CORNWALL.

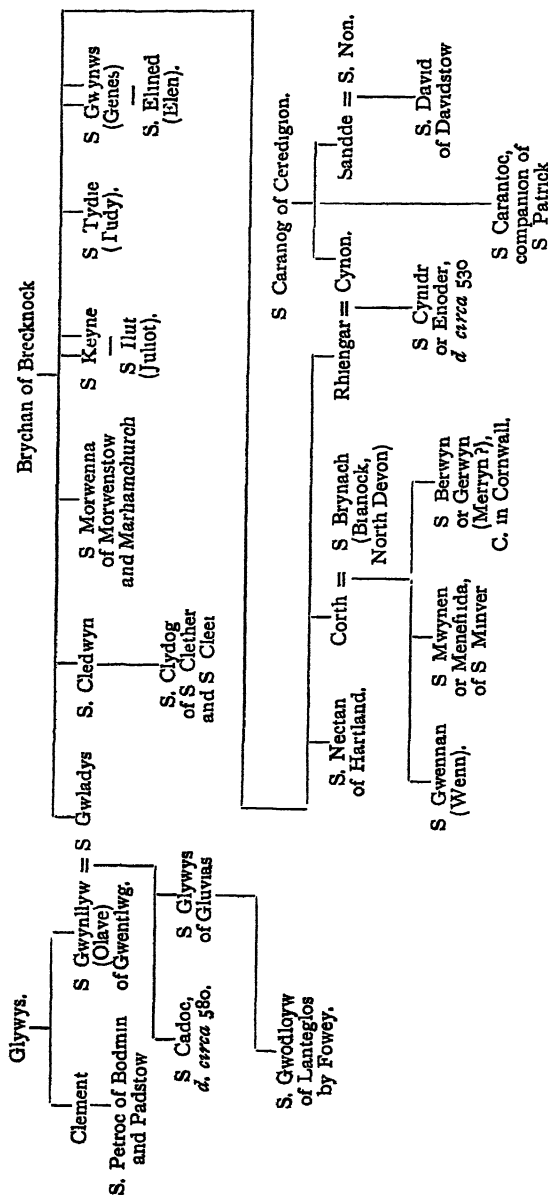

Note.—The exact relationship to Brychan cannot be determined. Some of the saints represented as children of Brychan may have been grandchildren, and some represented as brothers and sisters may have been first-cousins. They all, however, belonged to the royal family, with family rights to land, either secular or ecclesiastical.

X.—FAMILY OF LLYR MERINI AND CARADOG FREICHRAS.

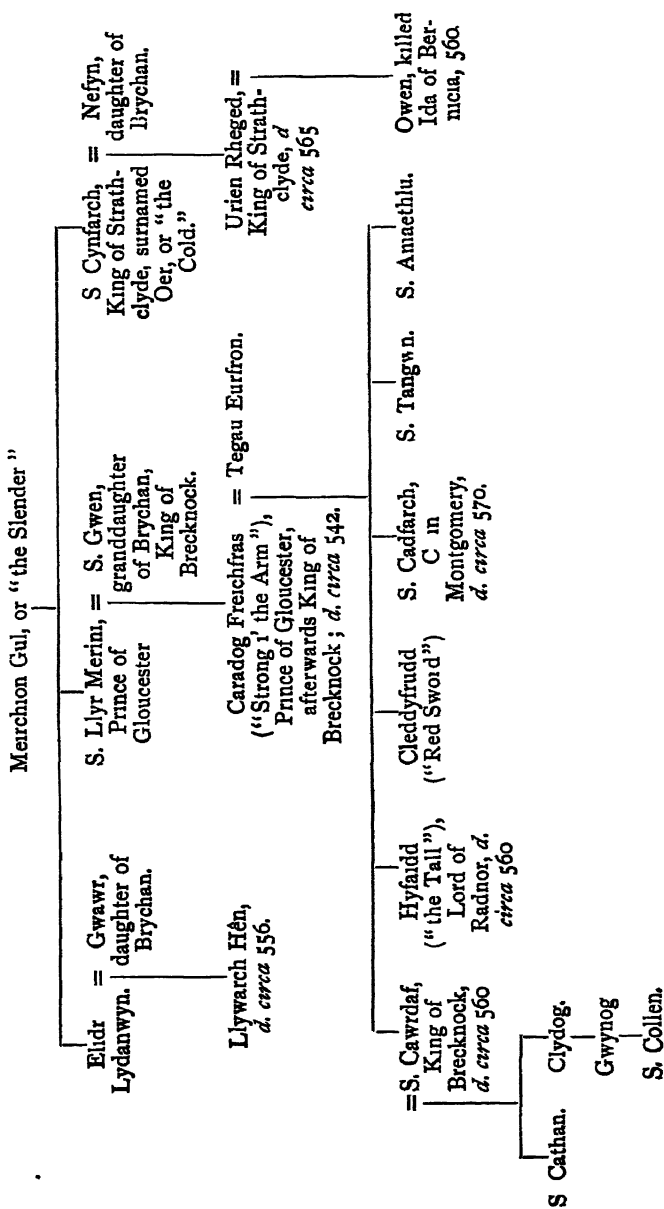

XI.—FAMILY OF CAW (ONE OF THE THREE HOLY FAMILIES OF BRITAIN)

[It will be seen by the dates that in this case, as in that of Brychan, grandchildren have been reckoned as sons.]

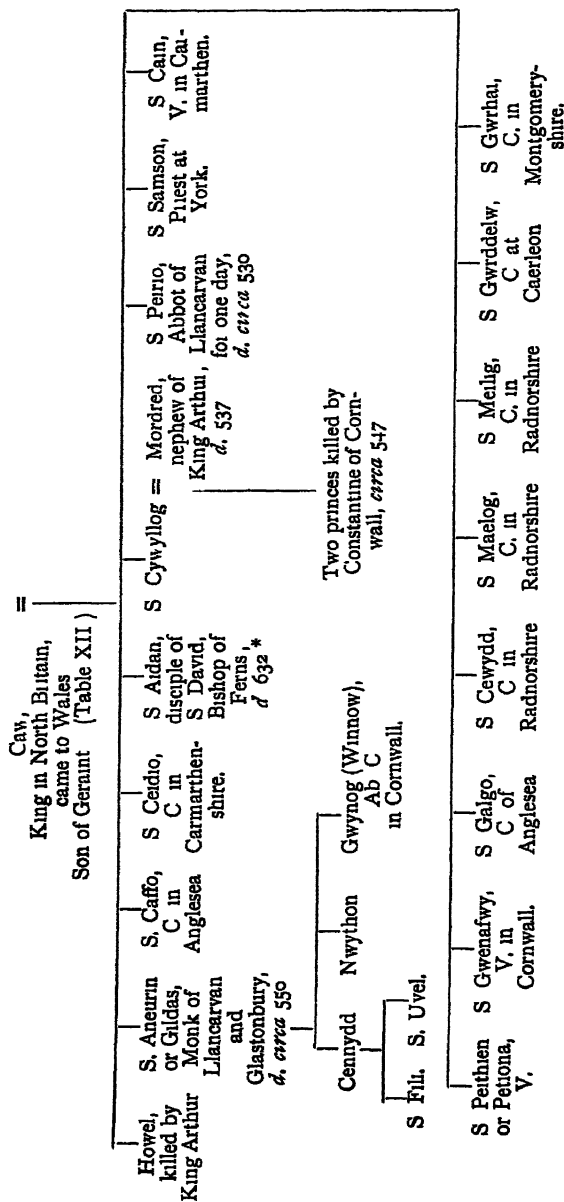

* Probably a grandson

XII.—FAMILY OF GERAIT, PRINCE OF DEVON

To some extent this is conjectural Great confusion exists between the several Geraints and Constantines
 It is possible that the Constantine of Gildas, 547, may have been father or uncle of the Constantine whose conversion is marked in the Welsh and Irish
 Annals as taking place in 588 or 589. Uthr is represented as son of Constantine I., but this can hardly be the case

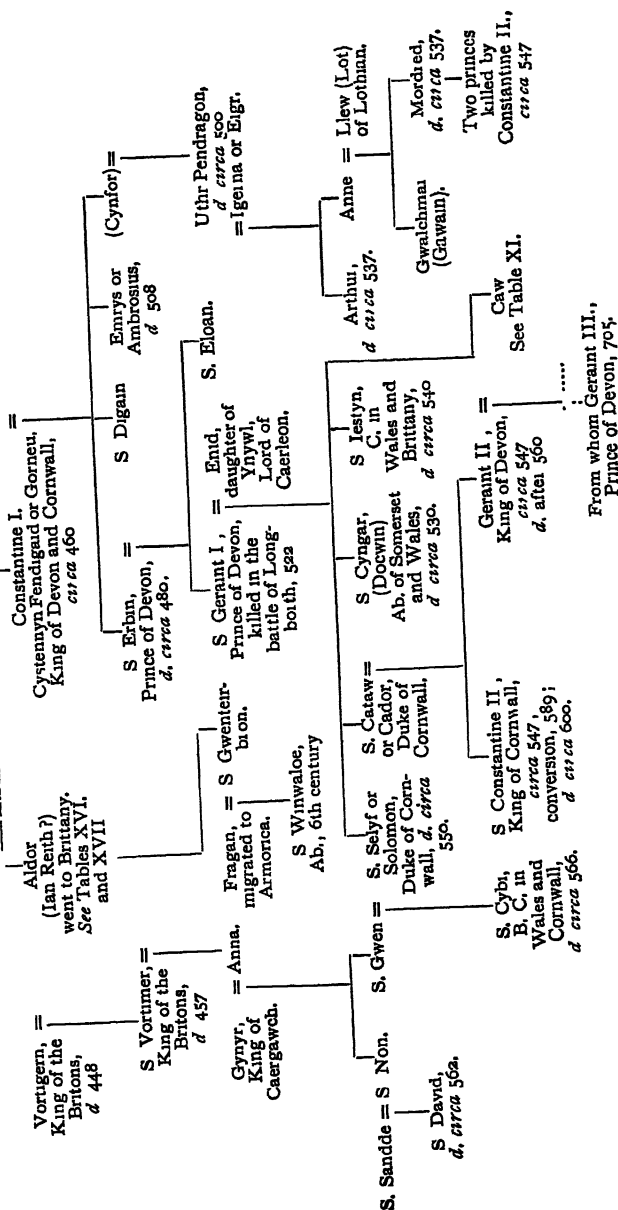

XIII.—FAMILY OF S. DAVID.

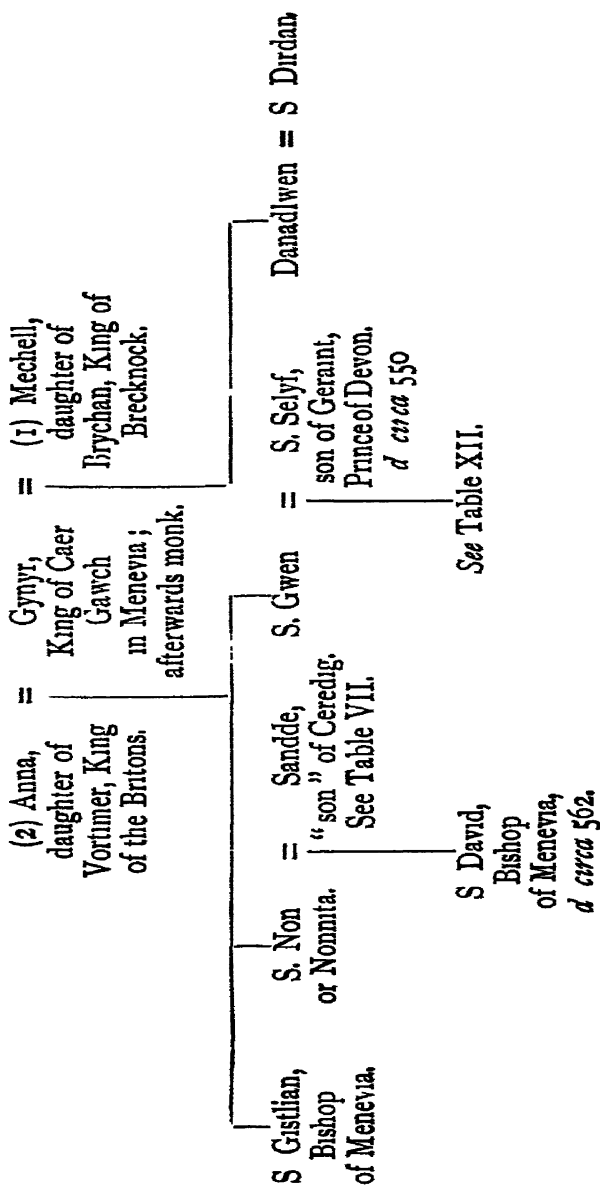

XIV.—FAMILY OF S. CADOC AND S. PETROC.

Note — Petroc and Cadoc are in Welsh Pedrawg and Cattawg.

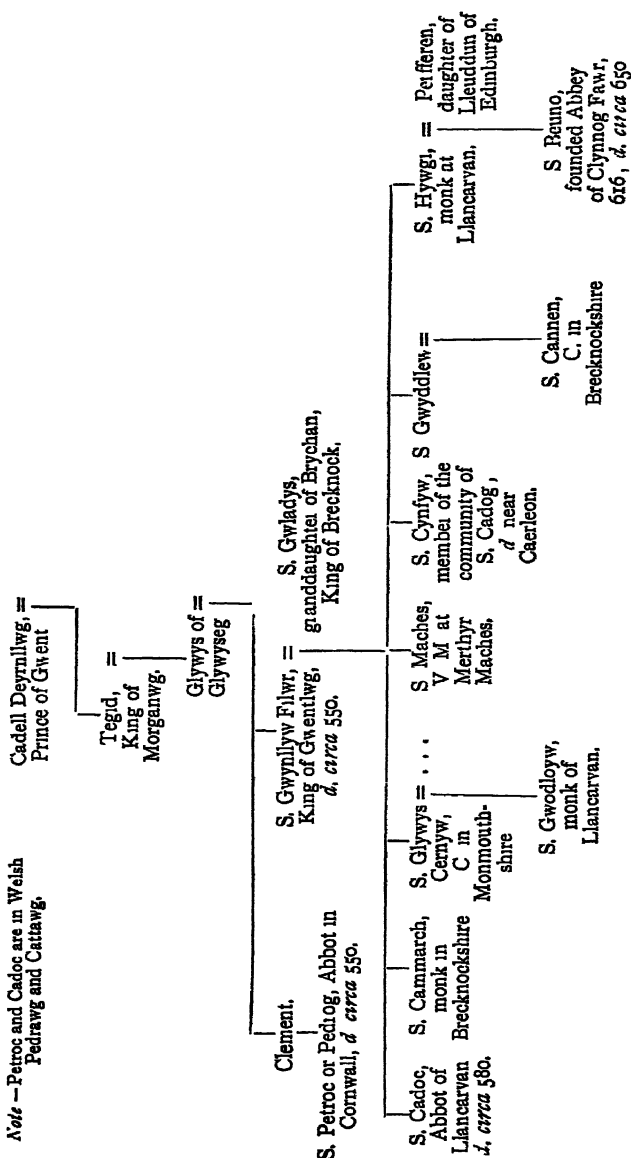

XV.—FAMILY OF S DEINIOL AND S. ASAPH.

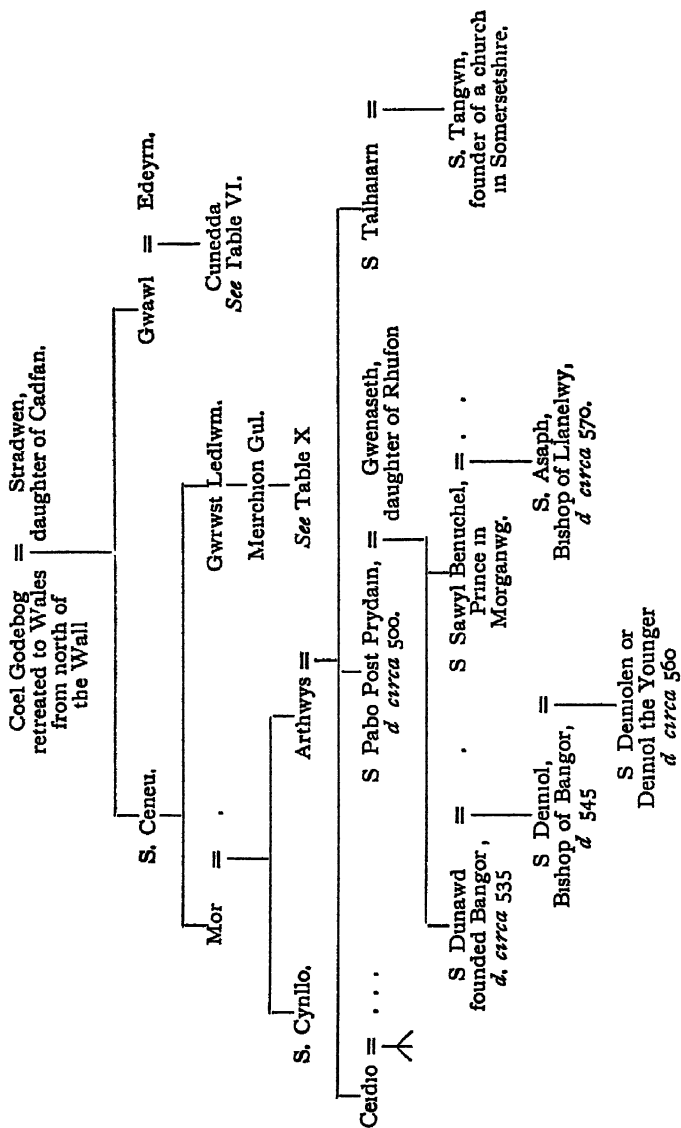

XVI.—FAMILY OF S. SAMSON AND S. PADARN.

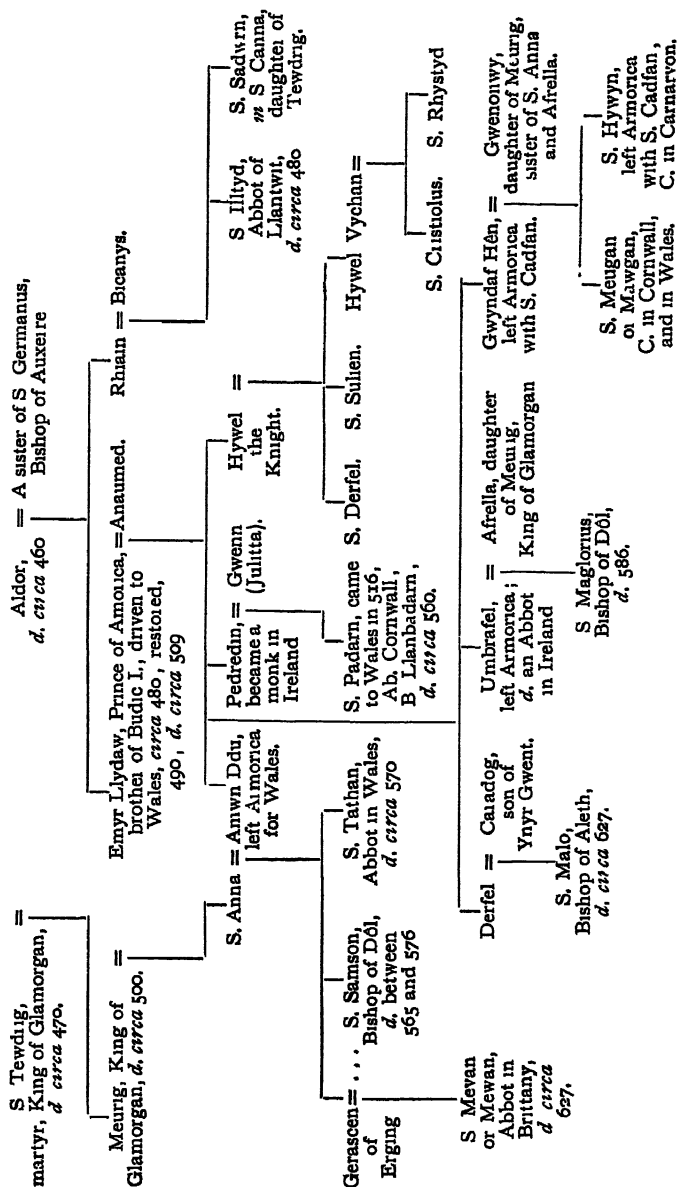

BRITTANY

XVII.—PEDIGREE OF THE PRINCES OF CORNOUAILLE AND DOMNONIA.
(TO SOME EXTENT CONJECTURAL)

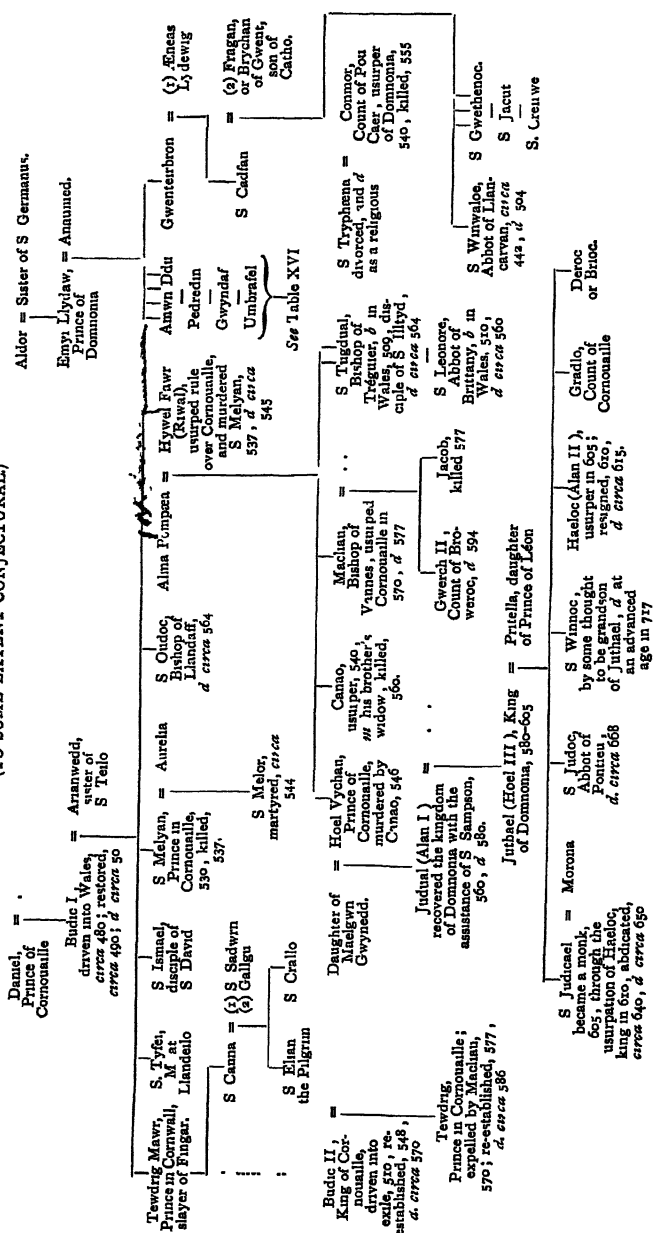

See Table XVI

XVIII — PEDIGREE OF THE FAMILY OF S. POL DE LÉON.

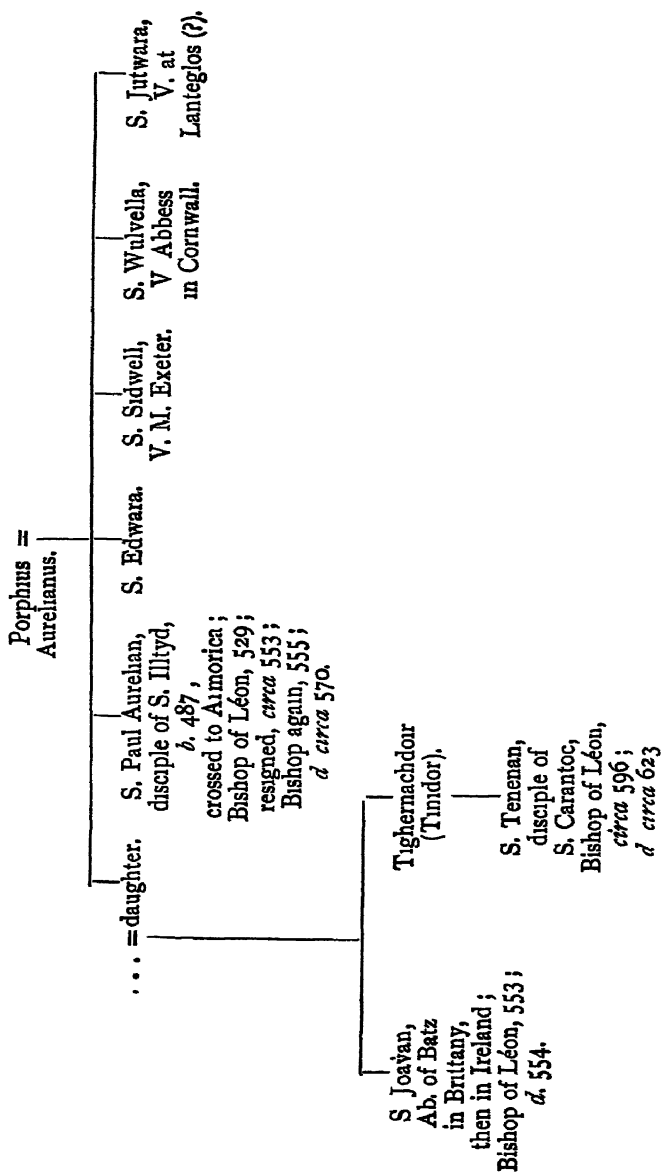

NOTE—The numbers before the children refer to their mothers

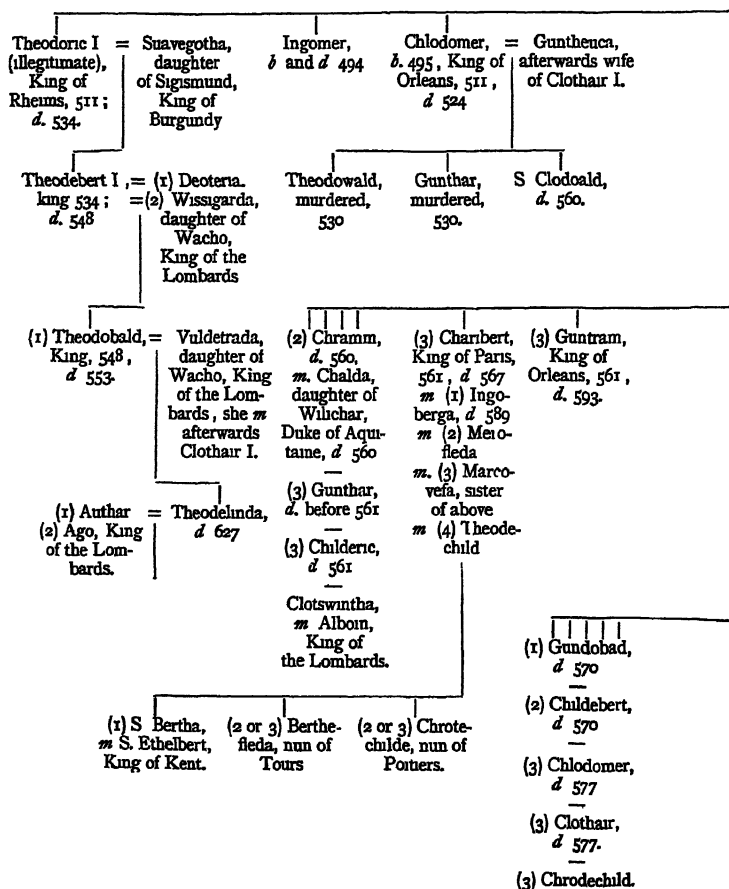

FRANKISH KINGS.

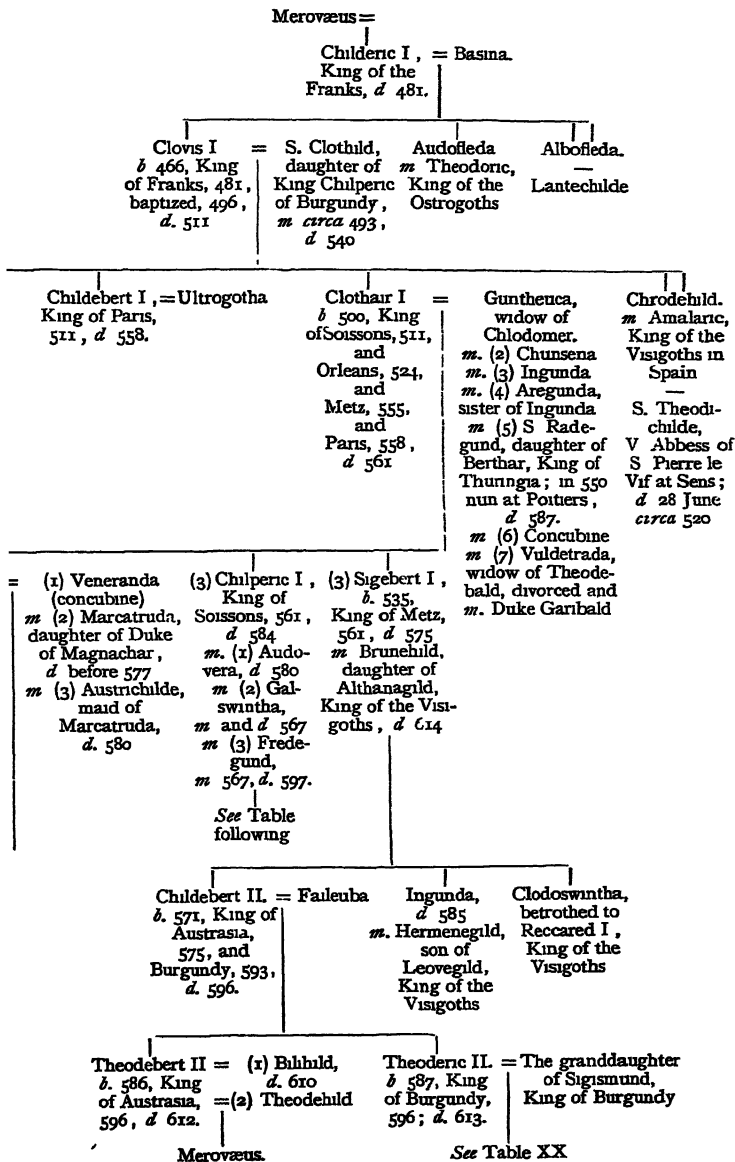

XX.—TABLE OF DESCENDANTS

NOTE — *The numbers before the children of Chulperic and Clothair refer to their mothers.*

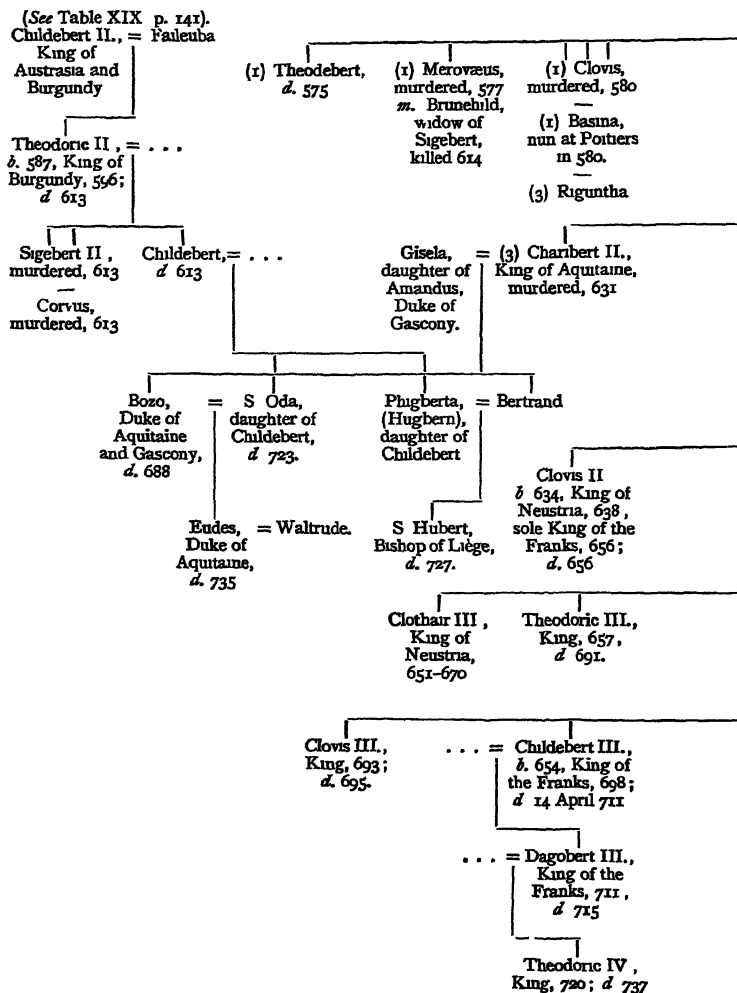

OF CHILPERIC I.

Chilperic I, =
King of
Soissons, 561,
d. 584

(1) Audovera,
deserted, 567,
murdered, 580
m (2) Galswintha,
married and
murdered, 567.
m (3) Fredegund,
first concubine,
then wife, 567;
d. 597

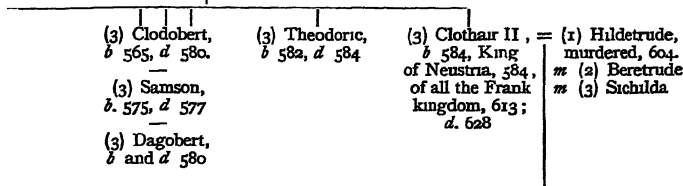

(1) Merovæus,
d. 604.

Dagobert I, =
King, 622;
d. 638

(1) Ragntrude (concubine)
m (2) Gometrude, sister
of his stepmother,
Sichilda
m (3) Nanthild.
m (4) Wulfegund
m (5) Berthild.

= S Bathild,
d. 680

S Sigebert III, = Hymnegild.
b. 630, King
of Metz, 638,
d. 656

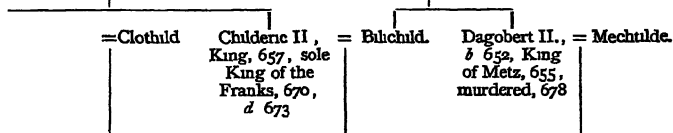

... = Chilperic II
(Damel),
King of
Neustria, 715,
d. 720

S. Irmina,
nun at
Horem,
d. circa 690

S Adela,
nun at
Horem,
d. circa 695.

Sigebert,
d. 678.

Ragutrude

Childeric III, = Gisela,
King of the
Franks, 743,
deposed, 752;
last of Mero-
vingian kings

XXI.—TABLE OF BURGUNDIAN KINGS.

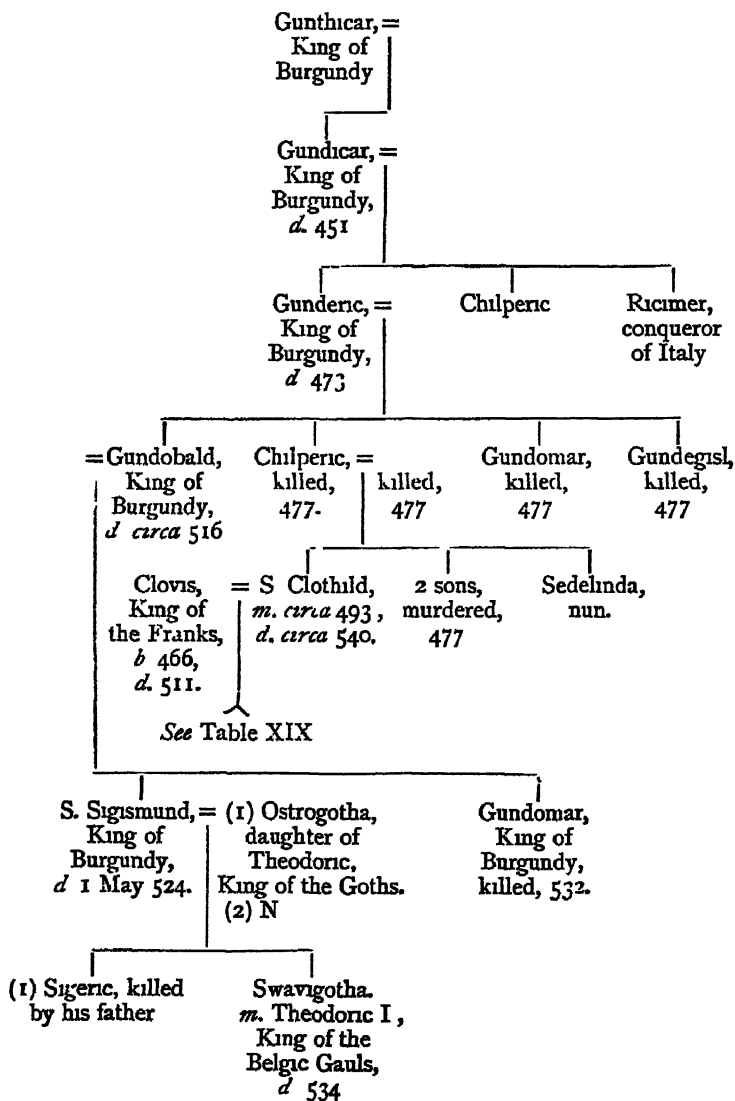

XXIV.—FAMILY OF

NOTE.—*The numbers before the children of*

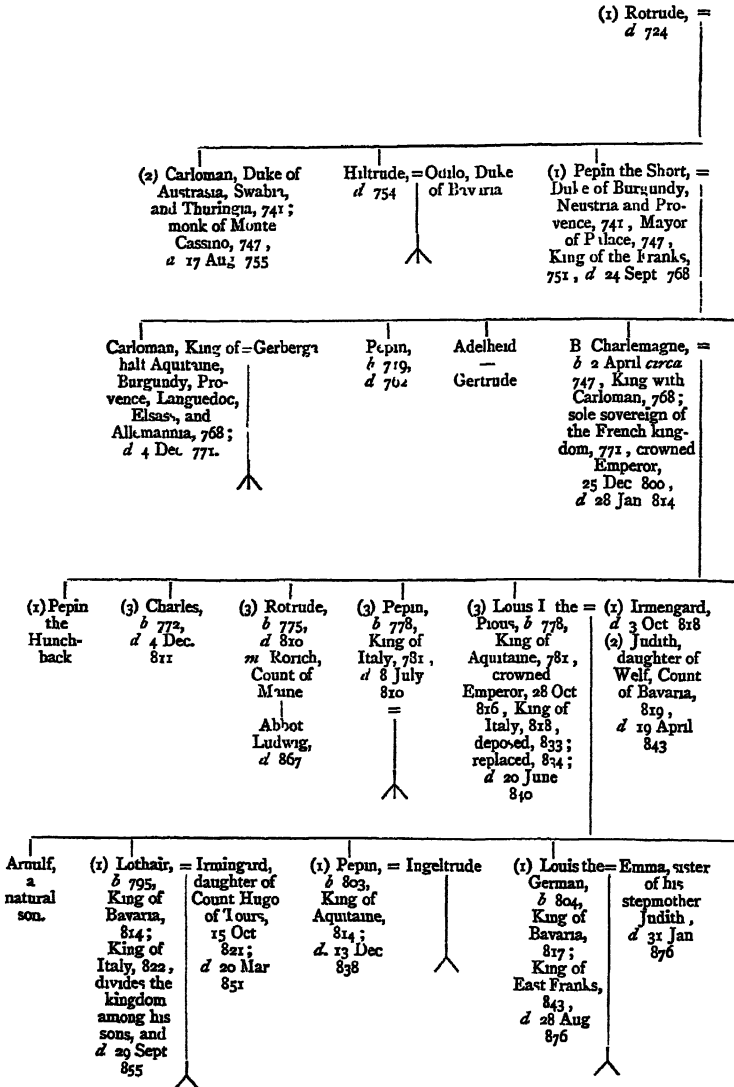

CHARLEMAGNE.

Charles the Great and Louis refer to the mothers

Charles Martel, = (2) Swanhilda, = (3) Gunnebild (concubine).
 Mayor of Palace daughter of = Other concubines

Theodobert,
 Duke of
 Bavaria, retired
 in 741 to Abbey
 of Chelles

Bertha or = Gripho,
 Bertrada, killed,
 daughter of 753
 Count
 Herbert of
 Laon,
 d 12 July
 783

S Adeloga,
 V Abbe-s
 of Kitzingen,
 8th century

S Remigins,
 Bishop of
 Rouen,
 d 19 Jan
 771

Bernard,
 Count

= Gundlendis,
 daughter of
 Adalbert,
 Duke of
 Allemannia

Jerome
 —
 Hiltrude
 —
 Landrada.

See Table

(1) Himiltrude (concubine)
 (2) Desideria, daughter of
 Desiderius, King of the
 Lombards, divorced
 771

S Gisela,
 b 757;
 Abbess of
 Soussons

S Isberga,
 nun at
 Ybergh,
 d circa 800.

(3) S Hildegarde, d.
 30 April 783

(4) Fastrada, d 794

(5) Luitgard, d 800

(6) Regina (concubine)

(7) Adeltrude

(8) Gerswintha "

(9) ~~Na...~~

Ma. Theodora

(3) Lothar,
 twin
 brother of
 Louis,
 d 780

(3) Bertha,
 afterwards
 nun at
 Centulle
 m S. Angel-
 bert, Abbot
 of Centulle
 d 18 Feb
 814

(3) Gisla
 (3) Adelheid
 —
 (3) Hildegard

(4) Theodrada
 —
 (4) Hiltrude

(6) Hugo,
 Abbot of
 S Quentm,
 d 844.

(6) Drogo,
 Bishop of
 Metz,
 d. 8 Dec
 855

Hartnid Nithard

(7) Theodoric, monk, d 819. (8) Adaltrude (9) Ruodhaide.

(1) Alpars
 m Bego,
 Count of
 Pans

(1) Hildegard
 m Count
 Theodoric

(2) Charles the Bald, = (1) Irmentrude
 b 13 June 823, Duke of Swabia, 829,
 King of Neustria, 843;
 and Aquitaine, 852;
 and Lorraine, 869,
 and Italy, 875;
 crowned 25 Dec. 875;
 d 6 Oct 877

(2) Richild

Gisela.
 m Eberhard,
 Margrave of
 Friuli

XXV.—FAMILY OF S. GREGORY, BISHOP OF TOURS.

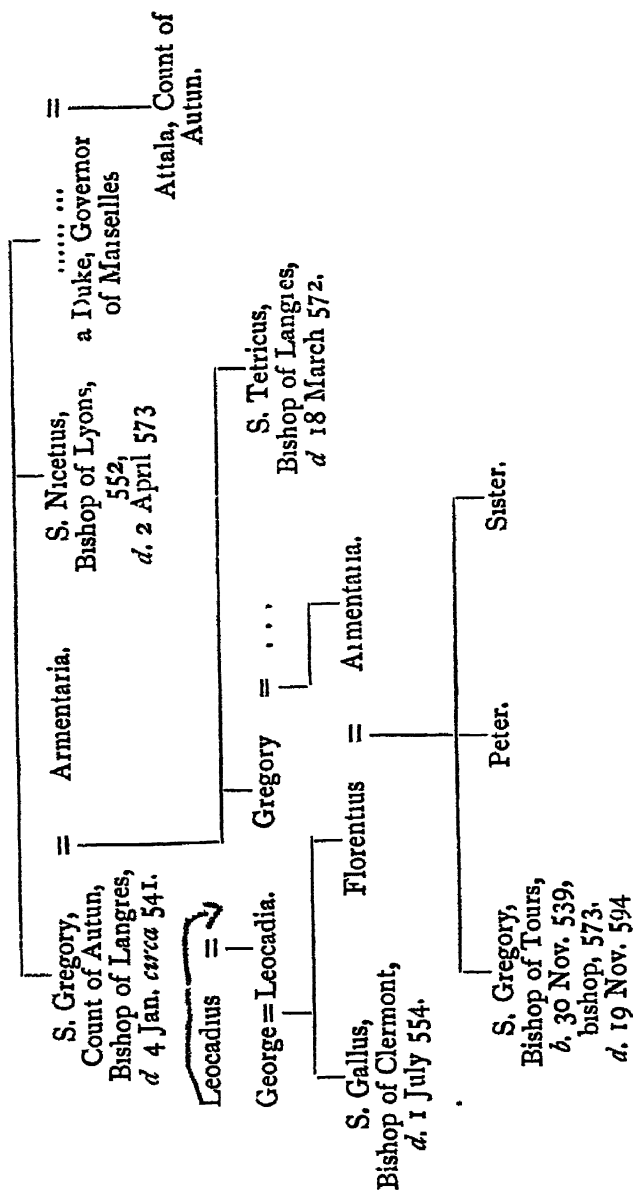

XXVI—FAMILY OF S. GERTRUDE OF HAMAGE.

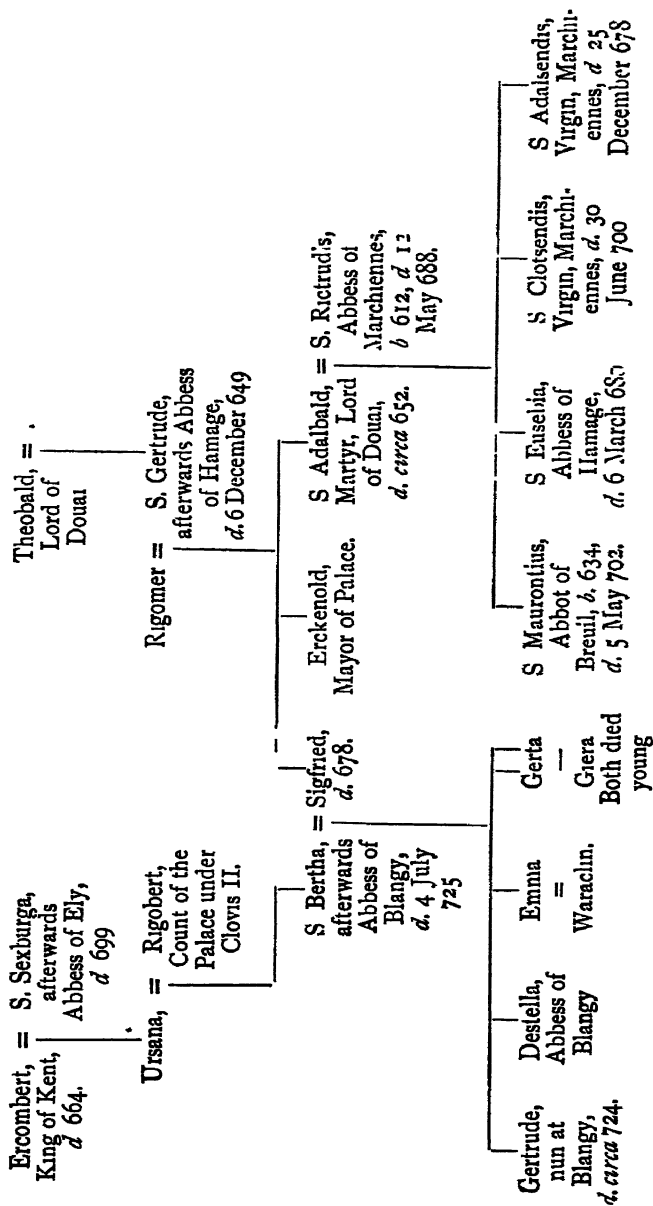

XXVII.—FAMILY OF S GERTRUDE OF NIVELLES.

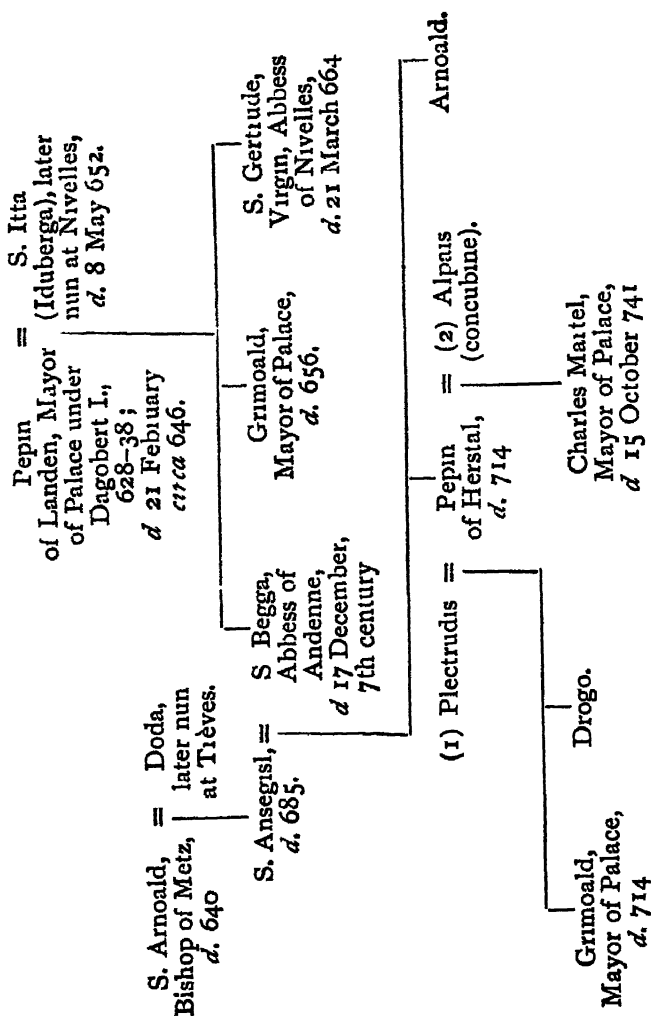

XXVIII.—FAMILY OF S WALTRUDE.

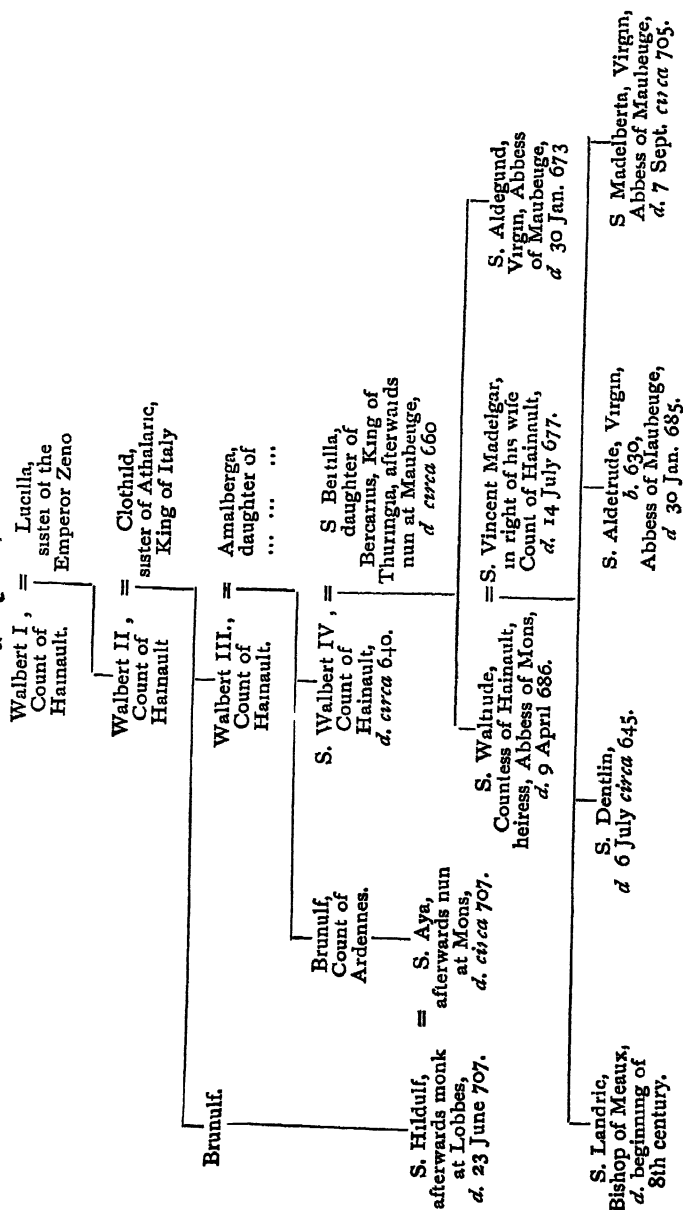

XXIX.—FAMILY OF S. ODILIA

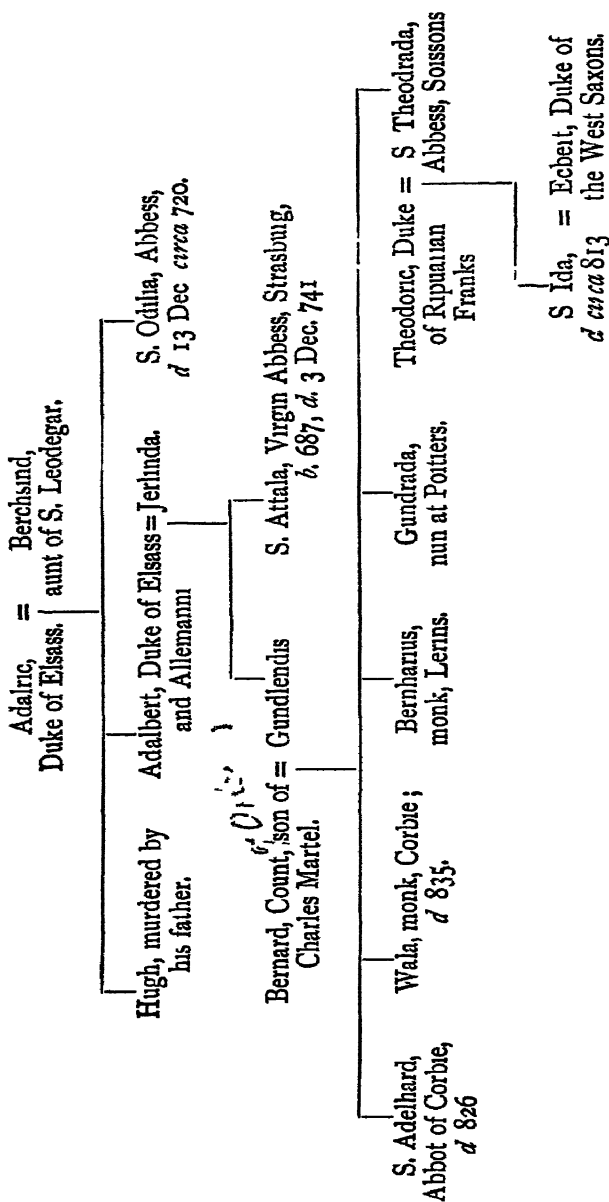

ANGLO-SAXON.
XXX.—THE ROYAL AND SAINTLY FAMILY OF THE KINGS OF KENT.

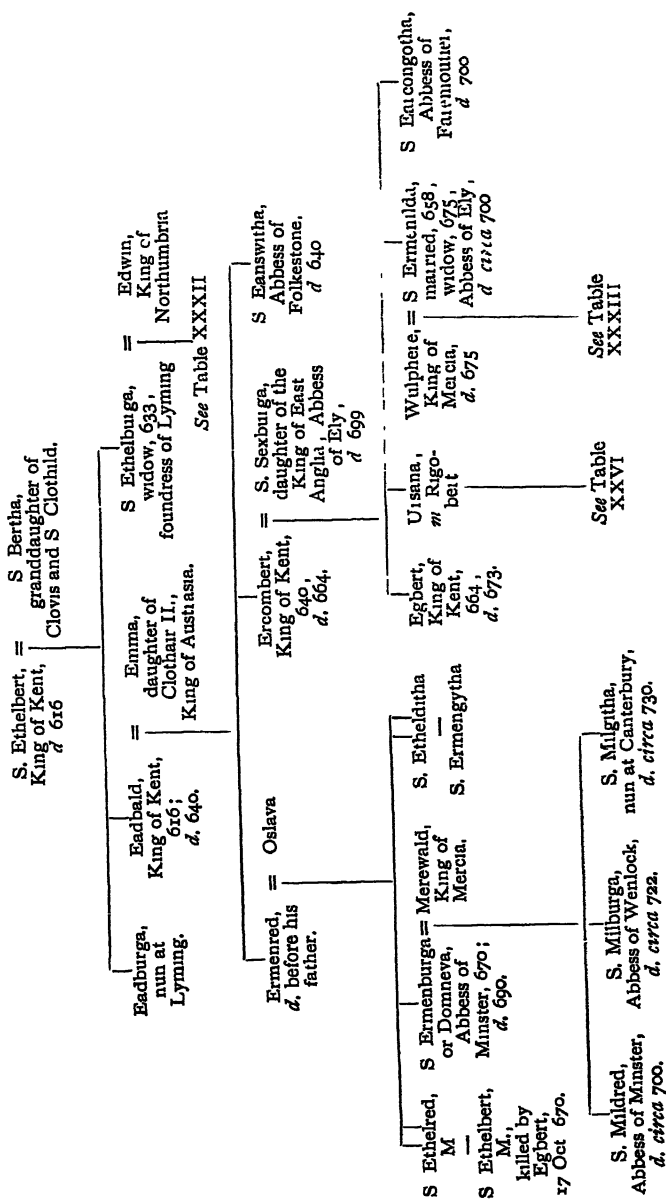

XXXI.—ROYAL AND SAINTLY FAMILY OF NORTHUMBRIA (BERNICIAN DYNASTY).

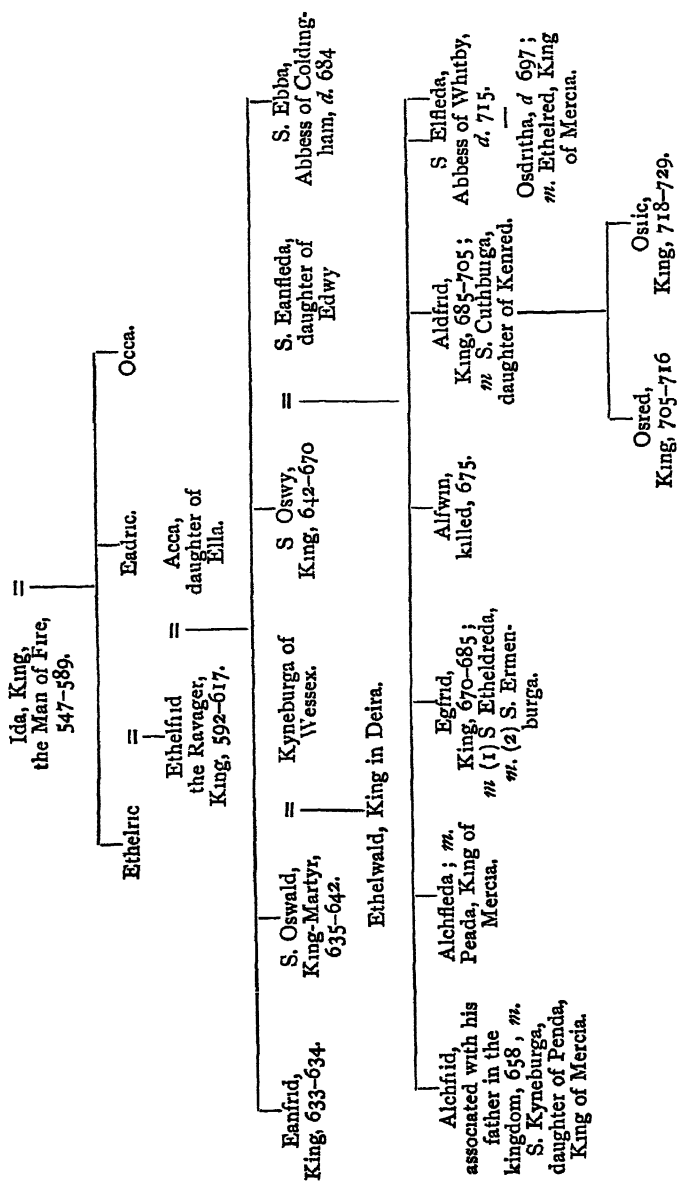

XXXII.—ROYAL AND SAINTLY FAMILY OF NORTHUMBRIA (DEIRIAN DYNASTY)

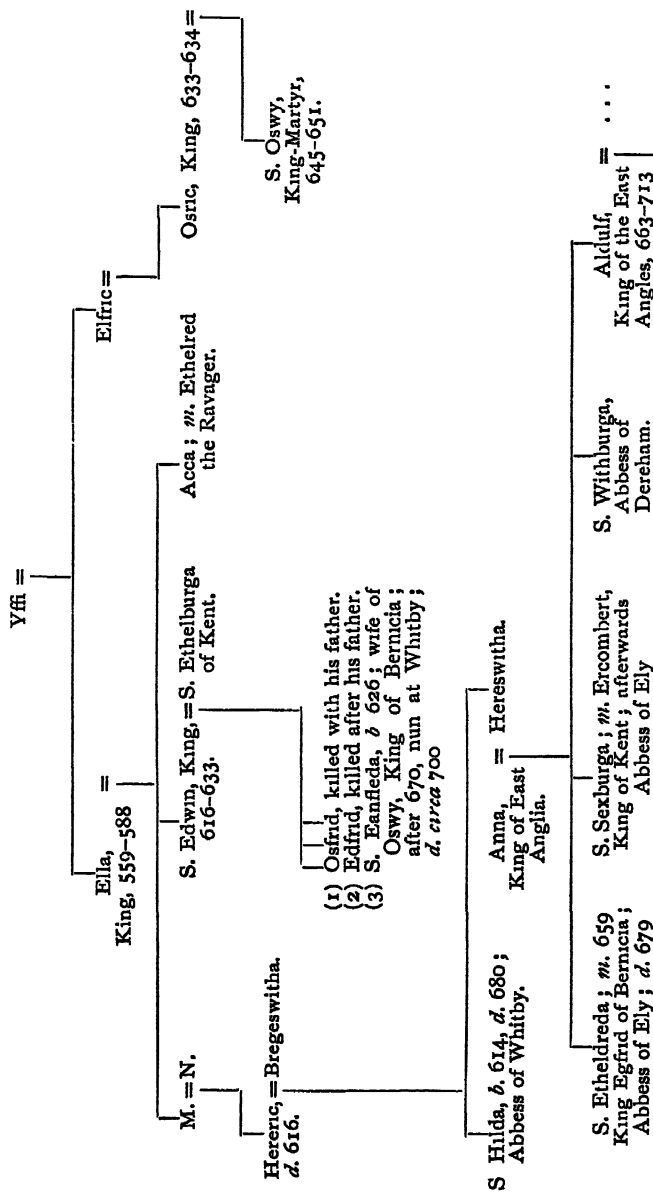

See Table XXXIV

XXXIII.—THE ROYAL AND SAINTLY

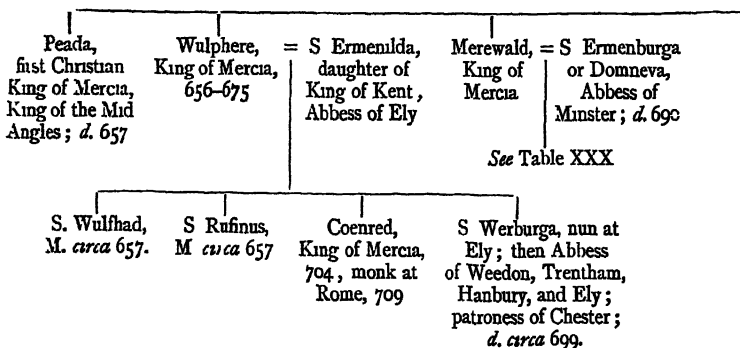

XXXIV —THE ROYAL AND SAINTLY

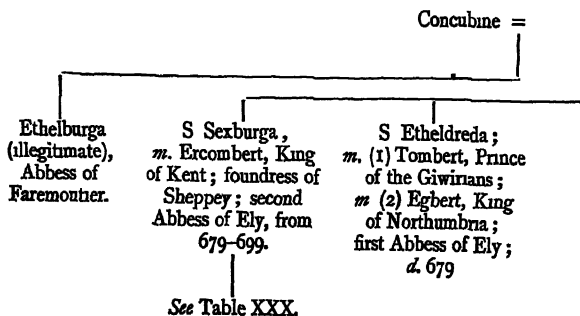

* According to Bede she was wife of Edelhere,

FAMILY OF MERCIA

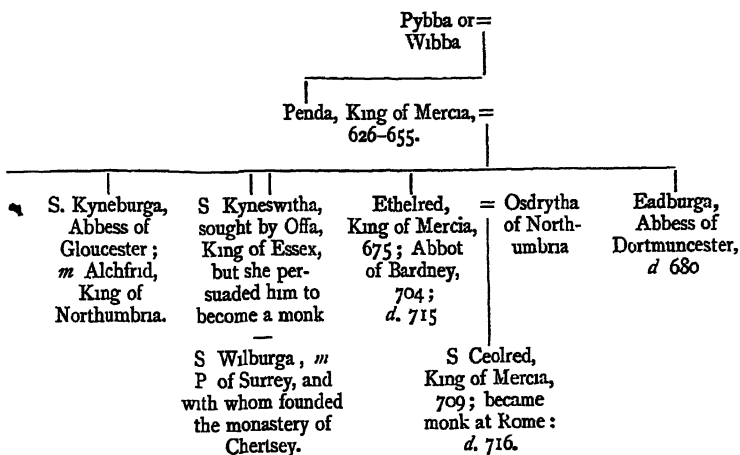

FAMILY OF EAST ANGLIA.

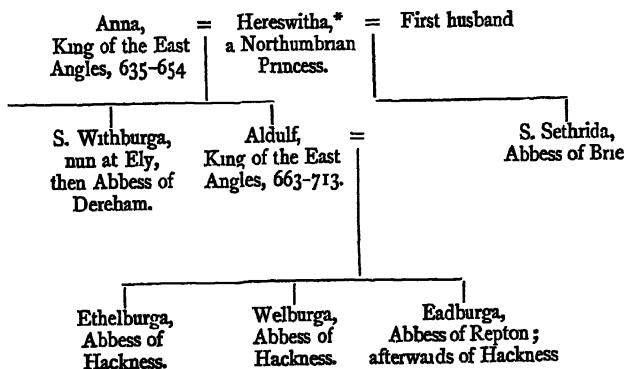

and he was father of King Aldulf by her.

XXXV.—ROYAL AND SAINTLY FAMILY OF WESEX.

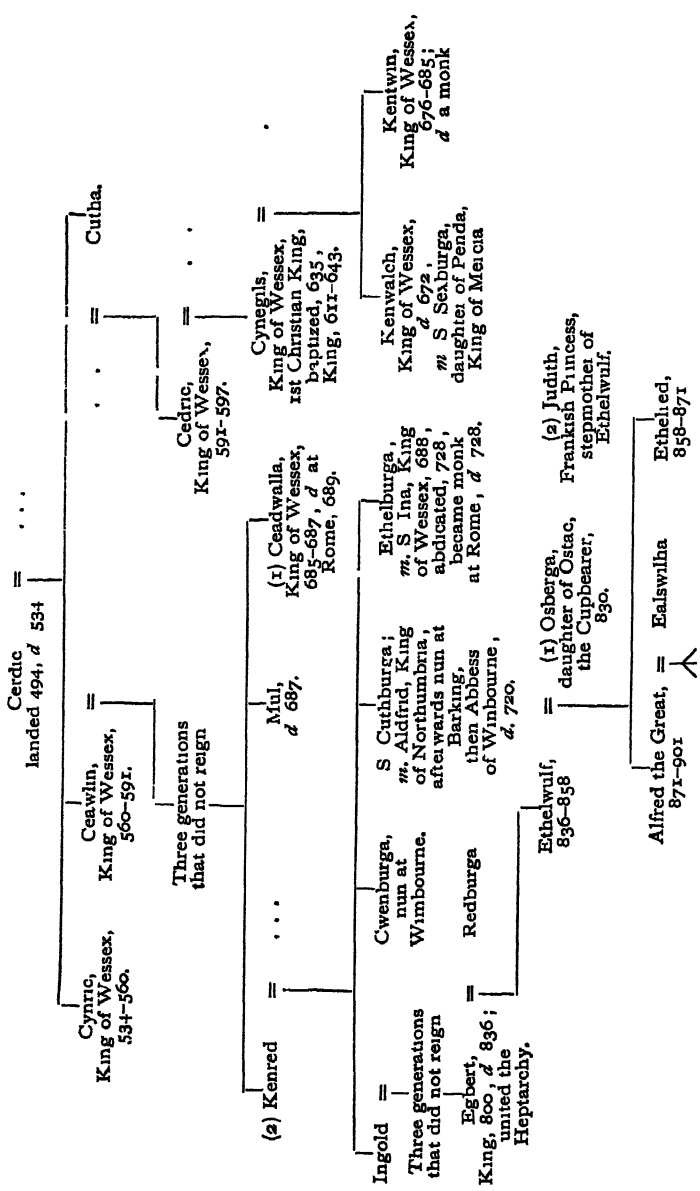

A CELTIC AND ENGLISH KALENDAR OF
SAINTS PROPER TO THE WELSH, COR-
NISH, SCOTTISH, IRISH, BRETON, AND
ENGLISH PEOPLE.

[(L) attached to a name signifies that the *Life* is given in the text of the preceding volumes, any other references are to dates under which the additional notices appear in this Calendar]

JANUARY

- 1 ELFAN and MEDWY (ELVAN and MEDWIN), *BB. Wales, end of 2nd cent (L).* See also May 14 and 24, August 8, and September 26

MAELRYS, *C. Carnarvonshire, 6th cent*

GWYNHOEDL or GWYNODL, *Mk. C. Carnarvonshire, 6th cent.*

MOCHUA or CUAN, *Ab. Ireland, 6th cent. (L).*

TYFRYDOG, *C. Anglesey, 6th cent.*

MACHRAITH, *C. Anglesea and Merioneth, 7th cent.*

MOCHUA or CRONAN, *Ab Balla, in Ireland, 7th cent. (L).*

ERNAN, *co Donegal, circa 634, also December 22*

MAELRYS, his name also spelt Maelerw or Maelryd, son of Gwyddno, the son of Emyr Llydaw, belongs to the first half of the sixth century. He was a cousin of Cadfan, and almost certainly came with him to Wales from Armorica, in that large company of saints that then migrated to the British Islands. Maelrys, like his cousin, settled in Bardsey.

GWYNHOEDL or GWYNODL was son of Seithenyn, warden of the dykes of the low-lying tract of land off the coast of Cardigan, that formed the cantref of Gwaelod. In the sixth century, by a

sudden submergence, the sea overflowed this district. The king of the district of Gwaelod was Gwyddno Longshanks. It was the duty of the warden to ride along the embankments that kept out the sea, and which had probably been raised by Roman legionaries, as were those which shut out the Severn from Caldecot level and Wentlooge. But Seithenyn was given to intemperance, and neglected his duty. Whether there was an actual submergence or not, the blame for the waves overflowing and devastating the district was laid upon Seithenyn. The occasion was doubtless a concurrence of neap-tide and strong westerly winds. Gwyddno and his court were keeping revel that night, and Seithenyn was very drunk. The king escaped with difficulty before the inrolling stormy sea. It is said that by this calamity sixteen palisaded caerau were destroyed. Such persons as escaped fled to the mountainous region about Snowdon. The recollection of the disaster produced a saying attached to a heartbroken sigh; it was likened to

The sigh of Gwyddno Garanhr,
When the waves rolled over his land.

A short poem, attributed to Gwyddno, is preserved, in which he laments —

“Stand forth, Seithenyn, and behold the dwelling of heroes
the plain of Gwyddno is whelmed by the sea.
Accursed be the sea warden, who, after his carousal, let
loose the destroying fountain of the raging deep.
Accursed be the watcher, who, after his drunken revelry,
let loose the fountain of the desolating sea.
A cry from the sea rises above the ramparts · even to
heaven does it mount,—after fierce excess comes a long
lull.
A cry from the sea rouses me in the night season.
A cry from the sea rises above the winds.
A cry from the sea drives me from my bed this night ”

Probably the disgrace that attached to Seithenyn's whole family after this terrible catastrophe induced his sons to retire entirely from the world and devote themselves to religion. His ten sons embraced the monastic life under Dunawd, at Bangor Iscoed. (For Merin see *January 6.*)

TYFRYDOG was the son of Arwystli Gloff, a brother of Diheufyr, Tyrnog, Tudur, and Twrog. He was a member of the college of Bardsey, and founded the church of Llandyfrydog. He lived down to the close of the sixth century.

MACHRAITH Of this saint nothing is known

ERNAN was nephew to the great Columba, and was a servant-boy in the monastery of Clonmacnois. When Columba visited this place in 590 Ernan strove to touch the hem of his rough cloak, when the saint, seeing the effort of the lad, held out his hand, took him, and placed him before his face. Some of the bystanders bade him take no notice of a troublesome boy; but Columba silenced them, laid his hands on the head of Ernan, blessed him, and said, "This boy whom ye now despise will henceforth be agreeable to you, and will go on from grace to grace, and be gifted by God with wisdom, learning, and eloquence."

Along with his brother, Cobtach, he followed his uncle to Alba, to labour at the conversion of the Picts. After many years spent there he returned to Ireland, and established himself at Drumhorne, in Donegal. Adamnan says that on the night that Columba died, it was revealed to Ernan in vision. In the Irish calendars he is called Ernan of Rathnew, in Wicklow, but it is somewhat uncertain whether there were not two of the same name. In Ireland his memory is revered on August 18, but in the Scottish calendars his name occurs on January 1. He died in the year 634.

2 **HOLY MARTYRS OF LICHFIELD, circa 304 (L.).**

SCOTHIN, C. Ireland, circa 550.

SEIRIOL, C. Anglesea, 6th cent.

SCOTHIN was a native of Ireland, who came to Britain and studied under S. David, and the manner of his coming was this:— He was a disciple of S. Aidan, Bishop of Ferns, in Ireland. Aidan had been a pupil of S. David, and he loved his master dearly. Now it fell out on Easter Eve that whilst Aidan was in prayer it was revealed to him that David was in great peril, for three false brethren had put poison in his bread, so as to destroy him. Then Aidan tearfully besought the Lord to deliver his old master. And an angel appeared to him, who said, "Send thy fellow disciple Scothin to the seaside, and I will enable him to pass over." Then Scothin did cheerfully what he was bidden, and he walked in the water till it reached his knees. Thereupon appeared a sea monster, and took him on his back and landed him on the other side, on Easter Day at noon, and he met David coming from church, and told him the message of Aidan.

In the refectory David took the poisoned bread and broke it into three pieces. One he gave to a crow, the second to a dog, but the third he ate himself and took no hurt, though crow and dog died. Then "all the brethren arose and lamented, and cursed the steward, cook, and deacon, and with one mouth condemned them and their successors, that they should never inhabit any portion of the kingdom of heaven."

After a while Scothun returned to Ireland, and lived as a solitary in a cell constructed by himself on Mount Marge, in Queen's County. After an edifying life he died on January 2, but the exact year is not known. It was about 550.

SEIRIOL was the son of Owain Danwyn, and brother or nephew of Eimon, prince of Llyn, in Carnarvon, of the race of Cunedda. Eimon established a sacred tribe at Penmon in Anglesea, and made Seiriol chief of the saintly tribe. So celebrated did this establishment become under him, that foreigners, so we are told, even Scandinavian vikings, resorted to it for instruction. This is a clumsy way of explaining that some Norse pirates who had been captured on the coast were given up to Seiriol, instead of being put to death. Seiriol and Cybi were friends. The former lived at Penmon, the latter at Holyhead. They were wont to meet weekly at Clorach, near Llanerch y Medd. From the circumstance of Seiriol travelling westward in the morning with the sun, whereas Cybi's course was eastward against the sun, they were denominated Seiriol the Fair and Cybi the Tawny. Matthew Arnold wrote a sonnet on this story, but mistook the point. He makes Seiriol the Bright, because the sun was on his face, and Cybi the Tawny, because his was in shade.

Late in life Seiriol retired to Glanach or Priestholm, a little island off the coast. This islet is now called Ynys Seiriol. He lived in the early part of the sixth century. Challoner gives January 2 as his day, but in his supplement gives as well February 11. There is some question whether February 1 was not also observed as his day in Wales. There used to be an inscription on a stone in the tower of Llanengan to the memory of his father. In Welsh Calendars on February 1.

- 3 MELOR, *M. Cornwall or Brittany, circa 538 (L.).*
 GWENOG, *V. Cardiganshire, 7th cent.*

MELOR, son of Melyan, prince of Cornwall, is not to be mistaken for Melyr, brother of S. Maelrys, who is commemorated on January 1.

The story of S. Melor is involved in difficulties, partly because his legend is replete with fables, next because it contains anachronisms, and lastly, because the scene of his adventures is regarded as either Cornwall or Cornouaille, and his place of martyrdom is claimed to be at both S. Mylor in the former, and at Lanmeur in the latter.

Sweeping aside all the fabulous matter in the legend, we come to those particulars which are historical. Melor was the son of Melyan, prince of Cornwall or of Cornouaille, probably of both. Melyan was the son of Budic, and his brother, Tewdric, was prince of Western Cornwall, where he made himself notorious through his opposition to a settlement of Irish immigrants in Penwith, he went so far as to kill some of them, Fingar and Piala. The brother of Melyan was Hoel I, cousin of King Arthur, who had been sent by Arthur to rule as prince in Brittany. Hoel, called in the legend Rhiwal, that is to say, the Lord Hoel, finding Melyan in the way, murdered him in 538, and sought to destroy also his nephew Melor, who, however, fled to the abbey of S. Corentin to escape him. Here comes in the anachronism. In the legend it is Corentin who affords him shelter. But that is impossible, as Corentin died in 453; and all we can admit is, that he was for a while sheltered by the successor of S. Corentin. There may be some truth in the story that Melor was mutilated by Hoel, and this mutilation of hand and foot was designed to incapacitate him from becoming a candidate for the chieftainship. But when, in spite of this, a party was formed to support Melor, then Hoel proceeded to extremities and had him assassinated.

With regard to Melyan the father, the traces of his having been in Cornwall are many. Not only are S. Mellion and Mullion churches dedicated to him, but also near Par are Lan Mellion and Merthan close together, indicative of an ancient *martyrium* and a church dedicated to the saint. In S. Tudy is another Lan Mellion, another at Liskeard, and there are other less distinct traces of his foundations. That he was a prince in Cornwall, therefore, I can hardly doubt. But that Melor fled to Brittany from Hoel, who was now in Britain and then in Armorica, is most probable. It is true that in Cornwall is the church of Mylor dedicated to him, and believed to occupy the site of his martyrdom, but it may be only a commemorative church. The adjoining parish is S. Mabe, *i.e.* the Holy Son, and it is possible that the original church at Mylor may have been a foundation of S. Melyan, and that the adjoining church was known as that of the Saintly Son; but that gradually the

greater fame of the boy eclipsed that of his father, and his name was transferred to his father's foundation. This, however, is mere conjecture. Linkinhorne is dedicated to S Melor, so also is Thornbury, in Dorsetshire. His relics were held to be enshrined at Amesbury. All this points to a very close relation with the south-west, and to the story having taken a lively hold of the Britons there, which could hardly have happened unless he had been related intimately to the reigning house.

In the *Legendarium* of Bishop Grandisson of Exeter, 1366, is the story. It begins - "S. Melor, son of Meliar, King of Cornwall, lost his father when he was seven years old. His mother was in Devon (in *Devonia regione*), Aurilla by name, of the race of Rivold." There is a doubt as to the exact relationship of Rivold and Melian. On the strength of a statement in a fragmentary Life, published in the *Analecta Bollandiana* (T v p 165), that Melor's mother was daughter of Judoc, Count of Domnonia, he has been moved to a date but little before 710. But Aurelia cannot have been a daughter of S Judoc, who was never married. Judoc may be a misreading for Budoc.

In Brittany tradition attaches to every stage of the flight of Melor from his uncle. His estates are said to have been at Lanneur, between Lannion and Morlaix, in Domnonia. Between Carhar and Lanneur, according to the legend, when he was pursued, the earth sank and formed a hollow, in which he concealed himself. This is still shown, and called Guele San Velar, or the Bed of S Melor. A chapel was built over the spot. Thence he pushed on in the direction of Boiséon, but was overtaken by night and took refuge at a farm in Plouigneau, now called Gouer Velar, or the rivulet of Melor. On leaving the farm next morning, without his breakfast, he ascended a hill and fainted from exhaustion, where now stands a small chapel dedicated to him at Coal-sao-bell (the Wood of the Long Ascent). Thence he pushed on to Boiséon. There Rivold came and carried him off to Lanneur, where he stabbed him at a spot near the parish church, which is pointed out as the scene of the murder. Indeed, even a room in the old wooden house is called *Cambr-ar-Sant*, or the Chamber of the Saint. Tradition is so minute in its particulars relative to the localities, that it is difficult to doubt that S Melor belongs to Brittany and not to Cornwall.

In Brittany the feast of S Melor is on October 3, and not in January, and the form assumed by his name is Meleuc, which is a corruption of Melur-oc. In Bishop Grandisson's Exeter Calendar the feast is on October 1.

William of Malmesbury said of the story of Melor, in the twelfth century, "Incertum," and so it is still as to its details, but there can be little question as to the substantial truth of the story, that he and his father were the victims of a family contest for supremacy, such as was common in all times among the Celtic chiefs, where the law of subdivision of authority and land provoked these fratricidal crimes.

GWENOG, a virgin in Cardiganshire, of whom nothing is known To her was dedicated a church at Caerleon, a mile and a half from the town, at the angle between the Soar and Avon. It was destroyed at the Reformation She is not to be confounded with S Gwenafwy or Wennapa or Veep of Cornwall, nor with S Gwynog, the nephew of the latter and disciple of S. Cadoc, both of whom made settlements in Cornwall.

4 RUMON, *B.C. in Cornwall, Brittany, and at Tavistock, in Devon (L.).*

RUMON, ROMAN, or RUAN, was the name of a man of some note and importance. He is thought to be the same as the Ronan who was consecrated bishop by S Patrick, and to have visited Scotland. But although this is possible enough, knowing, as we do, how great travellers the Celtic saints were, yet it is advisable to hesitate about the identification.

That he came to Britain we know. And here local tradition comes to our aid. He made a foundation at Romans-leigh, originally Lan Roman, in Devon

Then the spirit of restlessness came over Rumon, and he moved away to the west, and settled in the *Pou* of Kerrier, where he elicited a fountain from the rock, and his church and holy well remain to this day His festival was there held on August 30 Another of his foundations was near Porthleven, where the parish still bears his name, as S. Ruan Major Another of his foundations is Ruan Lanhorne Lanhorne is a corruption of Llan-ruan In the church here is an interesting ancient figure of the saint, and there is a holy well in the midst of the village.

It was doubtless on his way west that he tarried at the mouth of the Fowey, where he founded a church, Llan-ruan, corrupted in Domesday to Lanlaron; but the port or basin of the harbour still bears his name unaltered as Polruan For some reason unknown, but probably no other than the love of change, he took boat and crossed to Armorica, and reached land on the west of

Léon, in the harbour of Aber Ildut Ascending the valley he came on wild and unpeopled country There they show to this day a rock hollowed out, which is called the bed of S Ruan or Ronan The district was marshy and insalubrious, and he left it to move south, following the coast He came to the dense forest of Nemet, rolling down the flanks of the Menez Hom, and he planted his hermitage there on a height Between the mountain he occupied and the town of Curiosopitum, or Quimper, the country was fairly peopled, partly with the original non-Aryan race, dusky and broad-shouldered, partly with British immigrants, who had assumed the lordship over them. The wolves in Nemet troubled the natives greatly, dependent as they were on their flocks and herds The natives were pagans, but the immigrants had some smattering of Christianity. Ronan laboured hard to convert the heathen, and thereby provoked some hostility One of his principal opponents was a woman named Keban, young and good-looking, who was particularly irate because Ruan or Ronan had converted her husband, and she feared would turn him into a monk She accordingly accused Ronan of being a werewolf "Every night," said she, "he takes on him the shape of a wolf, and devours our sheep" She persisted in this charge, and even went before the British king Gradlo to formulate her accusation She had a little daughter. One night Ronan, in the form of a wolf, had burst into the cottage and carried off and eaten the child.

The concourse was immense; exasperation against the reputed werewolf was at its height She demanded justice of Gradlo against Ronan, and that he might be burned alive! The king sent for the saint. In the effervescence of minds it would not be well to take openly the side of the hermit, nor would it do to scout the charge, as then the people would with their own hands wreak vengeance on the saint.

So Gradlo said, "Bring him to me. I have two wolf-dogs. If he is innocent, they will not hurt him, but if they sniff anything of the wolf about him, they will tear him to pieces"

The people were delighted Meanwhile Gradlo, who did not desire the death of the hermit, had his hounds well fed, and probably let them see him in intimate commune with the saint On the day appointed Ronan and the hounds were confronted He raised his hand and said, "Do what God wills." They came and licked his feet.

That sufficed At once the stupid and ignorant rabble roared out that Keban had been guilty of slander, and they would burn her. Ronan with difficulty rescued her. He persuaded the mob

to search her house, and promised that there they would find her child concealed. This was done. The little girl was discovered hidden away.

Unhappily the legend of S. Ronan is fragmentary, and we know of no more incidents in his life, nor anything concerning his death.

In the ninth century his relics were translated to his oratory in Loc-Ronan-ar-Coat-Nevent, or the Chapel of Ronan, in the Wood of Nemet. There is also a church of his foundation in the diocese of S. Briec, Lanrenan. In Brittany he is commemorated on June 1, but this probably is the day of the translation.

But Tavistock Abbey claimed to possess his relics, translated thither by Ordulph, Earl of Devon, in 981.

I have assumed that the Ronan of Brittany is the Ruan of Cornwall and the Romanus or Rumon of Devon, as the legend represents the Breton saint as coming from Britain, and identifies him with the disciple of S. Patrick, who travelled greatly.

- 5 EDWARD THE CONFESSOR, *K. England*, A.D. 1066 (L. on October 3).

6 THE EPIPHANY.

MERIN, *C. Monmouthshire, Carnarvonshire, 6th cent.*

EIGRAD, *C. Anglesea, 6th cent.*

HYWYN, *P.C. Bardsey and Carnarvonshire, end of 6th cent.*

EDEVRN *the Bard, C. Anglesea, 6th cent.; also Nov. 11.*

ULCHED, *C. Anglesea.*

PETER, *Ab. Canterbury, A.D. 608 (L.).*

MERIN or MEIRYN was trained at Bangor under Dunawd. He was the nephew of Gwynhoedl (see *January 1*). In Wales S. Merin is commemorated on January 2, and he is the patron of Bodferin, in Carnarvon, and of Llanferin, in Monmouthshire. The church of Lanmerin, in the old diocese of Tréguier, in Brittany, is possibly dedicated to him.

EIGRAD, son of Caw and brother of S. Samson of York. He was trained in the religious establishment of S. Iltyd. He founded a church in Anglesea in the sixth century (Challoner.)

HYWYN, variously spelt Hefnin, Henwyn, Hewnin, was the son of Gwyndaf Hên, or "the Aged." Gwyndaf was an Armorican chief, and brother of Amwn the Black. He retired

into Wales, and became head of the college of Dubricius at Caerleon. In his old age he retreated to Bardsey, where he lies buried. Hywyn his son accompanied Cadfan from Brittany. He was first a member of the college of Iltyd, and afterwards bishop in Bardsey. He founded the church of Aberdaron, on the opposite coast of Carnarvon, from whence pilgrims crossed over to the Holy Isle (Rees)

EDEYRN the Bard was son of Nudd, of the family of Maelgwn Gwynedd. He was one of the most valiant knights of the court of King Arthur.

The story was told that three giants occupied the hill of Brentenol, and when, one Feast of the Nativity, King Arthur was feasting at Caerleon, to prove Edeyrn he sent him to fight these giants. Edeyrn was successful. He slew all three, but was so exhausted by the struggle that, when King Arthur arrived on the scene, he lay insensible on the ground, and Arthur reproached himself for having been the cause of his death, and he vowed masses for his soul. Edeyrn, however, revived.

In the *Mabinogion* is a story of an encounter between Geraint, prince of Devon, and Edeyrn, "the Knight of the Sparrow-hawk." There was set up yearly in a meadow a silver rod between two forked sticks, and on this a sparrow-hawk, and for it knights jousted. Edeyrn won it for two years in succession. Had he won it the third, it would have been his for ever; but Geraint contested the prize with him, and won it. The attendant on Edeyrn was a dwarf, who had struck one of the ladies of Queen Gweniver across the face with a whip. When Geraint had defeated Edeyrn he sent him to the court to apologise for the insult offered.

Edeyrn devoted the latter part of his life to religion. He lived in the sixth century. He is also commemorated on November 11. A church, Llanedern, in the diocese of Léon, in Brittany, is dedicated to him, and there his tomb is shown with his figure carved upon it.

ULCHED: nothing further is known of him than that he founded the church of Llechulched, in Anglesea.

7 CWYLLLOG, *C Anglesea, 6th cent.*

CEDD, *B. London, A.D. 644 (L).*

KENTIGIERNA, *W. R. Loch Lomond, Scotland, circa*

A.D. 733.

CWYLLLOG or CWYLLLOG was a daughter of Caw and wife of the traitor Modred, nephew of King Arthur.

KENTIGIERNA was a daughter of Ceallach Cualain, prince of Leinster, who died in 715. Ceallach was the ancestor of the O'Kellys of Rathdown, in the county of Dublin. She was married to Feradach, chieftain in Monchestree, and had for brother S. Coengan, and her son was named Faeltan. Him S. Ibar is said to have saved from drowning, when he saw the boy at the bottom of a lake playing with water-kelpies—translated in the legend into angels. Leaving Ireland, Kentigierna, accompanied by her brother and son, came to Straphulane, in Scotland, and finally she retreated wholly from the world and lived as a recluse in the island of Inch Cailleach, in Loch Lomond, where she died about 733.

- 8 PEGA, *V. England*, circa A. D. 718 (L.).
Translation of S. JUDOC (see July 25; December 13).
 WULSIN, *B. Sherborne*, A. D. 983 (L.).
- 9 FILLAN, *Ab. Scotland*, 8th cent. (L.).
 ADRIAN, *Ab. Canterbury*, A. D. 709 (L.).
 BRITHWALD, *Abp. Canterbury*, A. D. 731 (L.).
Translation of S. WILLIAM, Abp. York, A. D. 1283.
- 10 SETHRIDA, *V. Abs. France*, 7th cent. (L.).
 WILLIAM LAUD, *Abp. M. Canterbury*, A. D. 1644.
- 11 LLWCHAIARN, *C. Montgomeryshire and Cardiganshire*,
 6th cent.
 EGWIN, *B. Worcester*, circa A. D. 720 (L.)
- LLWCHAIARN was the son of Hugarfael and brother of Aelhaiarn and Cynhaiarn. Nothing further is known of him than that he founded churches in Montgomeryshire and Cardiganshire, and lived in the sixth century.
- 12 BENEDICT BISCOP, *C. Northumbria*, A. D. 703 (L.).
 - THIRTY-EIGHT MONKS, *MM Iona*, circa A. D. 750 (L.).
 AELRED, *Ab. C. Rivaux, Yorkshire*, A. D. 1166 (L.).

- 13 ERBIN OF ERVAN, *C. Devon and Cornwall, 5th cent*
 ELIAN *the Pilgrim, C Anglesea and Denbighshire, 6th*
cent (see February 22).
 SAERAN, *C Denbighshire, 6th cent.*
 ELERI, *V. Carnarvonshire and Denbighshire, 6th cent.*
 KENTIGERN, *B. Glasgow, A.D. 601 (L).*

ERBIN was the son of Cystenyn Gorneu or Constantine the Cornishman, a prince of Devon in the fifth century. No churches are dedicated to him in Wales. S Ervan, in Cornwall, is dedicated to him, and was probably founded by him. Hals gives Ervan as a corrupt form of Erbyn. When so many churches of Celtic origin were re-dedicated in the Middle Ages, Erbin was converted into Hermes, a martyr in the Roman Kalendar. He was also grandfather of S. Cyngar, Abbot of Congresbury. His brother Digain founded a church in Denbighshire, called Llangernyw, or the Church of the Cornishman. Erbin was undoubtedly a chieftain, and he probably retired from the world to dedicate his life to God, where now stands the church in North Cornwall that bears his name. The date of his death is about 480. The Welsh Kalendars commemorate him as well on May 29.

ELIAN GRIMIAD, or "the Pilgrim," was the son of Gallgu Rieddawg, and his mother was Canna, daughter of Tewdwr Mawr, the son of Budic I. The church of Llanelian, in Anglesea, was formerly resorted to by a great concourse of people, who implored his aid for relief from a variety of disorders, and to gain his favour considerable offerings were made. These amounted to so large a sum that three tenements were purchased with it, which belong to the living to the present day. S. Elian's Well, at Llanelian, in Denbighshire, obtained great notoriety as a cursing well. On payment of a fee to the keeper of the well, persons devoted the names of their enemies to the vengeance of the saint, by inscribing them on pebbles and dropping them into the water. By this means they brought upon them ciamps, agues, and losses. This custom survived to the present day.

A singular confusion has arisen through mistaking Ehan with S. Hilary. S. Cybi and Ehan were wont to meet at a place called Llandyfydog, between Holyhead and Llanelian, there to confer upon subjects of religion. From this arose the idea that Cybi had been a disciple of S. Hilary—Elian's epithet, Ceimiad ("pilgrim"), being mistaken for Cannaid ("bright"), and so

corresponded with the Latin Hilarus, or Elian resembling Hilary, produced the mistake. Consequently, not only has this led to difficulties in reconciling dates, but also it has been the means of churches founded by Elian being re-named in honour of S Hilary. One of the Scil / Isles, where probably Elian resided and had an oratory, now bears the title of the Bishop of Poitiers; and although the wake of Elian is observed in the month of August, his festival has been regarded as on January 13, because that is the day of the commemoration of S Hilary of Poitiers. But Hilary belongs to the fourth century, and Elian to the sixth.

In Cornwall, Elian must have been almost as well known as his friend Cybi, whom he probably followed thither. He was the founder of S Allen's church, in Powder, where his feast is observed on the third Sunday after Easter. He had a chapel in Suthmy.

14

15 **ITA OF YTHA, V. Ireland, A. D. 750.**

LLEUDDAD, Ab C. in Carmarthenshire, 6th cent.

SAWYL BENUCHEL, Prince C at Bangor, 6th cent.

SAWYL FELYN, C. in Carmarthenshire, 8th cent.

CEOLWULF, K.C. Lindisfarne, A. D. 767 (L.).

S ITA OF YTHA, who may be regarded as the Bridget of Munster, was a daughter of Kennoelad and Necta, Christians, and of royal race. She was born about 480. From her earliest childhood she showed signs of the indwelling of the Holy Spirit, so sweetly modest and pious was she. It is related that, while she was still very young, the room in which she slept seemed ablaze, and in the midst of this marvellous light the young damsel lay asleep, her face transfigured to superhuman beauty.

She was sought in marriage by a noble youth, and her father greatly favoured his suit; but she obstinately resisted, and took the veil. She then retired to the south of the barony of Hy-Conall, in Limerick, where she led a solitary life. Numerous maidens placed themselves under her direction. She affected such abhorrence of money that after touching it she washed her hands; and her love of mortification was so great, that she allowed a great stag-beetle to gnaw into her side unmolested. This, however, is to be understood as implying no more than

that in her old age she suffered from cancer. She nursed and brought up the illustrious Brendan of Clonfert

So great was her fame, that when S Comgan of Gleanussen was dying, he sent for her to lay her hand on and close his lips. She lived to a very advanced age, and died on the 15th January 570

It is probably due to the presence of S Brendan in Devon and Cornwall that there are churches and chapels there dedicated to this great abess. She is there known as S Ide or S. Syth

LLEUDDAD, latinised into Laudatus, son of Alan or Emyr Llydaw, was a companion of S. Cadfan when this saint emigrated from Brittany. The incessant family feuds among the British settlers of Armorica was the cause of so large an immigration of men of princely families to Britain. Lleuddad was a cousin of Cadfan, on whose death he was appointed abbot of the monastery of Bardsey. Next to his predecessor he has been considered the guardian saint of the island. "Unloved is every unamiable person" is a saying attributed to him in Welsh literature. Probably he is the S. Laudus or Lo, Bishop of Coutance, who died 568

SAWYL BENUCHEL, or "the Haughty," was the brother of Dunawd, and son of Pabo, the Pillar of Britain, he stood out for the cause of the Britons in the North against either Picts or, more probably, the Angles, who conquered and settled the basin of the Tweed between 500 and 547, in which year the kingdom of Bernicia was constituted by Ida. It is possible that the family of Pabo may have been in part of Pictish origin. It is probable enough that Frisians had already settled in the valley of the Tweed, and that it is due to this that the Firth of Forth bore the early name of the Frisian Sea. Through the dim haze of northern tradition we see a chieftain struggling in battle after battle at the opening of the sixth century against invaders, till about the middle of the century the Britons were compelled to relinquish the basin of the Tweed and withdraw behind the Catrad, a line of embankments that strikes through Ettrick Forest.

According to Welsh tradition, the reason of Sawyl and Dunawd following their father into Wales was that they were unable to hold their own against the invaders; moreover, Sawyl's overbearing character drove his clansmen into revolt against him, and they expelled him. Dunawd threw himself on the protection of Cyngen, Prince of Powys, and he was given a tract of land, and founded a monastery at Bangor. But Sawyl the Haughty

appears in the Legend of S Cadoc as exercising authority as a petty chief in Glamorganshire. S Cadoc was mightily offended because one day Sawyl, together with his attendants, came to the monastery of Llancarvan and gorged themselves on the food and drink they found there, till they all lay down in a sleep of surfeit and drunkenness. Then Cadoc ordered his monks to shave off half the beards and hair of the sleepers, and with razors to cut off the lips and ears of their horses. When the robbers awoke they were still too stupefied to observe anything. But Cadoc knew full well that, as soon as they came to their senses, they would return and butcher them all; he therefore bade his monks go forth with psalms and hymns in procession. They advanced till they reached the mound on the top of which was the caer of Sawyl. The chief, seeing the monks arrive, and being now aware what had been done, rushed with his men down upon them, whereupon the ground gaped and swallowed them up, "and the fosse where they were engulfed is known unto this day." The story is puzzling, for, in the first place, one does not see how Sawyl got into Glamorgan, and next, because he was not swallowed up, but became a monk. Otherwise his behaviour to S. Cadoc was consistent with his passionate, overbearing character.

He was married to Gwenaseth, daughter of Rhufon Rhufoniog, and was the father of S. Asaph. Rees believed that Llansawel, on the Cothi, was his foundation, but it is more probably a foundation of Sawyl Felyn, or "the Tawny," who lived in the eighth century. (Welsh Cal B.M. Addl MSS. 14,912)

- 16 FURSEY, *Ab. in France and Suffolk*, A.D. 653 (L.).
HENRY, *H. Northumbria*, A.D. 1127 (L.).
- 17 MILDGITHA, *V. Kent*, circa A.D. 730 (L.).
- 18
- 19 BLAITHMAC, *Ab M. and Companions MM. Iona*, A.D. 824 (L.).
WULSTAN, *B. Worcester*, A.D. 1095 (L.).
- 20 FECHIN, *Ab. Fore, in Ireland*, A.D. 665 (L.).

21

22 BRITHWALD, *B. Wilton*, A.D. 1045 (L.)23 BOISIL, *Ab. Melrose*, circa A.D. 664.

BOISIL was a disciple of S. Cuthbert, and was abbot of Old Melrose. He is spoken of both by Bede and by the author of the Life of S. Cuthbert. He died in the great pestilence of 664.

24 CADOC OR CATAWG, *Ab. Wales*, 6th cent. (L.).

S. CADOC. In the text reference is made to La Ville Marqué, *La Légende Celtique*. La Ville Marqué is now somewhat discredited among scholars. His object was to write a popular and picturesque book, and he was indifferent as to his treatment of authorities.

S. Cadoc has left his impress in Cornwall, where a chapel at Padstow was one of his foundations. We are told in his Life that he produced a fountain in Cornwall by thrusting the end of his staff into the ground. After that he went on to Rome and Jerusalem, and brought home with him some of the water of the Jordan, which he poured into his Cornish spring. The miraculous power of the well was increased thereby a hundred-fold; therefore the Cornish people built a chapel on the spot near the well. Quethiock, now dedicated to S. Hugh, was possibly originally Eglyscadoc. At Llancarvan S. Cadoc lived like a prince, as he was; and the account is interesting, as it shows us what the conditions were in an ecclesiastical tribe. "He daily fed a hundred clergy, and a hundred soldiers, and a hundred workmen, and a hundred poor men, with the same number of widows. This was the number of his household, besides servants in attendance, and esquires, and guests, whose number also was uncertain, and a multitude of whom used to visit him frequently. Nor is it strange that he was a rich man and supported many, for he was abbot and prince." His biographer further states that his territory extended from Ffynnon Hên, the Old Well, and the Rumney, to a stream that enters the sea near Cadoston.

He seems to have been terrible in his curses. But the stories of the judgments which befell such as were cursed by him are doubtless later inventions, composed for the purpose of scaring

Welsh and Norman princes and barons from laying hands on the lands of the monastery

The curious story told of Cadoc carrying red-hot coals to his master, and of his then hiding the fire in the earth, where it got lost in some of the disturbances of South Wales, is due to a misunderstanding of the biographer. What Cadoc found was a vein of coal in Glamorganshire, and to this the people had recourse till the seam got covered by a fall of earth, or its situation was forgotten. For *fire* in the text we should read *fuel*

S. Cadoc visited Brittany, and founded a monastery in the island that bears his name in the lagoon of Etel (see p 107); he built there a church of stone, and made a causeway connecting the island with the mainland. But his tarrying in Brittany was not for long. Not to be confounded with S Cadog, son of Brychan, of Brecknock and Carmarthenshire

25 DWYNWEN, *V. Anglesea and in Cornwall, beginning of 5th cent.*

DWYNWEN was of the family of Brychan, king of Brecknock; she is numbered among his daughters, but this means no more than that she was closely allied by descent in blood. She founded a church in Anglesey, and if, as is possible, she, like so many of her sisters, brothers, and kinsfolk, came to Cornwall, then she must have settled at Ludgvan or Llan-Dwynwen. By the Welsh bards she has been regarded as the patron-saint of true lovers. She and Maelon Dafodri fell desperately in love with each other, but when he paid his addresses to her, in a spirit of levity she flouted him, and he retired deeply offended, and spread ugly reports concerning her. She was greatly distressed, and prayed to be relieved of her passion. An angel appeared and administered to her some drops of a heavenly balm, and at once her heart was lightened of its love-sickness. Next the angel dosed Maelon, who was thereupon turned into a lump of ice. Dwynwen prayed, and God granted her three requests. For the first she asked that Maelon might be thawed; for the second, that all who invoked her might obtain the husbands they desired or become indifferent to them; and for the third, that the desire to marry might for ever depart from her. A gilded image of her stood at Llanddwynwen or Llanddwyn, in Anglesey. A maxim attributed to her is "Nothing wins hearts like cheerfulness." Another Cornish foundation of hers was perhaps Adwen, now Advent, but formerly Llan-Dwen. The date of S. Dwynwen is about 460

- 26 CONAN,
- B Sodor*
- , A.D. 648.

THEORITGYTHA, *V. Barking*, 7th cent (L.).

CONAN, Bishop of Sodor, was the tutor of S Fiacre. Little is known about him.

27

28

- 29 GILDAS
- the Younger*
- ,
- Ab. Brittany*
- , circa A.D. 570 (L.).

VOLOC OR MACWOLOC, *Ab. B. Scotland*, A.D. 724.

VOLOC OR MACWOLOC was a stranger to Alba, but to what nation he belonged is not told us. He settled into a little hut of reeds and wattles, and led a life of great austerity. Possibly Voloc is the Irish Faelchu, and there was one of this name abbot of Iona between 717 and 724, and it was under him that the Celtic tonsure was abandoned and the Roman was adopted.

- 30 PEITHIAN,
- V. Wales*
- , 6th cent.

TYBIE, *V.M. Wales*, 5th centCHARLES, *K.M. England*, A.D. 1649

PEITHIAN, a daughter of Caw, and, like her sister Cwyllog (see under *January 7*), is buried in Anglesea. No churches are dedicated to her.

TYBIE was a virgin of the family of Brychan, King of Brecknock, and consequently of Irish origin. She is said to have been murdered by pagans about the middle of the fifth century. Brychan had a court at Llysbyrchemiog connected with the astounding fortified Carn Gôch near Llandeilo, in the valley of the Towy. He attempted to extend his authority in the direction of Morganwg and into Dyfed. It is probable that his encroachments met with resistance, and in a revolt or a riot Tybie was killed where now stands the church of Llandybïe, near which is a farmhouse called Gelli Forwynion, "The Grove of the Virgins," where tradition says she and her sister, S. Lleian, and others lived. Her holy well is hard by.

- 31 MELANGELL, *V* Wales, middle of 6th cent (see May 27)
 TYSSUL, *C. Montgomeryshire and Cardiganshire, 6th cent*
 AIDAN OF MAEDOC, *B Ferns, in Ireland, circa A.D.*
 632 (L.)
 WILGIS, *C Holderness, circa A.D. 700.*

TYSSUL was the son of Corun, of the family of Cunedda, and he lived in the sixth century, and founded churches in Montgomeryshire and Cardiganshire

WILGIS was the father of S Willbrod, Apostle of Friesland, and Archbishop of Utrecht Wilgis, along with his whole family, led a pious, God-fearing life Late on in life he retired to a headland on the banks of the Humber, beside a chapel dedicated to S Andrew The people of the neighbourhood resorted to him, believing him to have the gift of working cures A small community gathered about him, and formed a religious cell, that was afterwards a priory The great Alcum was at one time prior there, and he has left some account of the holy founder. He is venerated on this day at Echternach, but does not seem to have got into English calendars

AIDAN, Bishop of Ferns To the account given in the text may be added some characteristic stories

One day, as a boy, he kept sheep Eight wolves approached, and he pitied them, they were manifestly famishing, and he gave them eight wethers As he returned home, driving his flock, his aunt appeared in the distance, a woman with a hard mouth, and not disposed to pass over the loss of eight wethers So he cried to the Lord, and lo' eight wethers appeared to take the place of those eaten He was walking reading in the fields one day, when a poor stag that was being pursued by hunters fell on its knees before him Aidan placed his book between the horns, and continued reading The hunters drew off, not daring to kill the beast protected by the saint He and S Molass were great friends, and resolved to travel, if it might be, together Then they set up two sticks in the ground, and watched which way they should fall If together, they would be companions; if not, each would go in the direction indicated by the fallen stick. The rod of Molass fell south, that of Aidan north So they parted Three boys were drowned in a tarn Aidan was informed of it. He went to the lake, walked on the water till he saw the drowned boys at the bottom Then he summoned them, and they rose like corks. He gave them to their mothers alive

Whilst he was a disciple of S David, at Menevia, he incurred the anger of David for having left his book in the rain. David ordered him to prostrate himself on the seashore. Aidan obeyed, and David pardoned him, but forgot to tell him to rise. Afterwards, in his monastery, David wondered at the absence of his disciple, and inquired where he was. Some told him he had been seen prostrate on the beach. Then he sent, and Aidan was found there. The tide had risen and flowed about him, and yet he would not stir till released by his master. A man was brought to Aidan, born without eyes and nostrils, his face a blank. Aidan blessed him, when suddenly eyes appeared and nostrils gaped. He was inspired with particular animosity against the Saxons, and attended the Britons in their fights, and cursed their enemies with the best possible effect.

On his way back to Ireland, in a little boat, he arrived whilst a fight was going on, and the Irish king was slaughtering a number of pirates who had landed to ravage the land. Aidan began to ring his little hand-bell, and when the king heard the tinkle wafted over the waves, he desisted from the butchery, for he knew a holy man drew nigh, to whom such bloody acts were distasteful.

Aidan was granted land in a lonely district. He was troubled with wolves, but, having a compassionate heart, he gave a calf to them one night that belonged to "two cows." Next day the cook came to him to say that the cows would not give their milk, and lowed, and were restless because they had lost their calf. Aidan bade the cook stoop, and he stroked and blessed his head, and bade him go to the cows and let them lick it well. The cook did so, and the cows were comforted, "and," says the biographer, "the cows loved that cook like a calf."

Aidan fasted on one occasion for fifty days and as many nights, and in return was granted his petition, that thenceforth whoever should sit in his seat would certainly go to heaven.

One day he cursed a rock, and split it.

A certain Saran had assassinated the King of Leinster. Aidan cursed him that his hand should fall off, and not recover it until he had been pardoned by the murdered man. So Saran lay down beside the cairn of the king, with crossed hands on his breast. After several nights, the dead man spoke from the sepulchre: "Saran, you brute! I forgive you" (*O Sarane, brute, ignoscitur tibi quod fecisti*). When dead, a certain paralytic man was healed by rubbing himself with some spittle he collected from the dead lips.

This is a fair specimen of the stuff that fills the "Lives" of Irish saints.

FEBRUARY

- 1 KINNEA OF CENNEA, *V. Ireland, 5th cent.*
 CREWENNA, *V. Cornwall, beginning of 6th cent*
 BRIDGET, *V. Absb Kildare, A.D. 525 (L.)*.
 DARDUGDACH, *V. Kildare, A.D. 526 (L.)*.
 SEIRIOL, *C. Anglesea (see January 2)*.

CREWENNA was one of the Irish virgins who came with Breaca, Ia, Senan, and others to Cornwall at the close of the fifth or beginning of the sixth century. She suffered martyrdom at Crowan. Unhappily nothing further is known concerning her. The cause of the martyrdom was that Tewdric, himself a Christian, objected to the Irish invasion of his land in Penwith, and its appropriation.

- 2 LAURENCE, *Abp. Canterbury, A.D. 619 (L.)*.
 3 MEIRION, *C. Anglesea, 6th cent.*
 WERBURGA, *Abss Hanbury, in Staffordshire, beginning 8th cent. (L.)*
 FOTHADH II., *B. Scotland, A.D. 1093*.

MEIRION was the son of Owain Danwyn and brother of Emion the king, and of S. Seiriol. (*See Seiriol, January 2.*)

FOTHADH II was the last bishop of St. Andrews of the old Celtic Church, and on his death in 1093, King Alexander appointed in his room Turgot, the confessor of Queen Margaret, and all the property and rights of the saintly clan passed over to the Church under Roman obedience.

- 4 ALDATE OF ELDDAD, *B.M. Gloucester, circa A.D. 580*.
 MODAN, *Ab. Scotland, 7th cent. (L.)*.
 GILBERT OF SEMPRINGHAM, *Ab. England, A.D. 1189 (L.)*.

ELDDAD or ALDATE was the son of Geraint, the son of Carnog. He was descended from Cadell Deyrnllwg. He became

Bishop of Caer Loew, or Gloucester, after having been trained in the school of S Illtyd In 577 occurred the disastrous battle of Deorham, attended with the capture of Bath and Gloucester, which fell into the hands of the West Saxons. The bishop was not driven out, but during some affay he was killed, about 580.

- 5 INDRACT, DOMINICA, AND COMP., *MM. Glastonbury*,
8th cent (L.), also May 8.

RONAN, *B. Scotland*, 8th cent.

RONAN is mentioned by Bede; he died in 778; however, the Ulster annals give 737 (736) Ængus calls him Bishop Ronan the kingly, and says that he lies in Lismore But his name is best known in Scotland. There is some uncertainty as to his day, whether February 5, February 7, or February 9.

- 6 MAEL, MELCHU, MUN, RIOCH, *BB. Ireland*, end of
5th cent

INA, *K. West Saxons*, circa A.D. 728 (L.).

- 7 ANGULUS, *BM London* (L.).

MELDAN, *B. Ireland*, 6th cent. (L.).

RICHARD, *K.C.*, A.D. 722 (L.)

- 8 KIGWVE or CIWA, *V Wales*, 6th or 7th cent

CUTHMAN, *C Steyning, in Sussex* (L.).

ELFLEDA, *V. Abs. Whitby*, A.D. 716 (L.).

KIGWVE or KYWA is marked in the Exeter martyrology as commemorated on this day She is probably the same as Ciwa, a sixth or seventh century saint who is venerated in Monmouthshire.

- 9 EINION, *C. Wales*, beginning of 6th cent.

ATHRACTA, *V. Ireland*, 6th cent. (L.).

TEILO or THELIAU, *B. Llandaff*, circa A.D. 566 (L.).

EINION, the king, was of the family of Cunedda. This is a family that played an important part in Welsh history Cunedda

was a British ruler in North Britain, and was invited by the Welsh of Gwynedd to assist them against the Irish Goidels, who had possessed themselves of Mona and the greater part of North Wales. He sent his sons with their followers, and these sons, after expelling the Irish, possessed themselves of the lands they had released. This was soon after 409. Cardiganshire, Pembrokeshire, Carmarthen, as well as Gwynedd, were thus laid hold on and portioned up among the brothers. Some of the family became professional saints, that is to say, were constituted heads of ecclesiastical tribes. No less than fifty saints were reckoned as belonging to this family. Eimon Frenhin, or the king, was prince over Lleyrn, a division of Carnarvonshire. He founded Penmon, in Anglesea, and also a monastery in Bardsey. There was an inscribed stone in the tower of the church of Llanengan which he founded, and that bore his name, but it is of later date, and is now effaced. His death took place in the sixth century.

TEILO. The strong spring that rises near the ruined church of Llandilo, at Penally, near Tenby, is a holy well of the saint. In the farmhouse hard by, Mr. Melchior, the tenant, preserves the skull that was shown and used before the Reformation as that of S. Teilo. He is the hereditary guardian of the relic. The skull, as now preserved, is imperfect, only the brain pan remaining. The open sutures prove that it must have been the head of a young person, and as S. Teilo is said to have died at an advanced age, it could not have belonged to him. Moreover, a part of one superciliary ridge remains, and this is of slight elevation, so that it seems almost certain to have been part of a young woman's head. Patients drink the water of S. Teilo's Well out of his reputed skull, and many cures are recorded.

At some time S. Teilo must have been in Cornwall and in Brittany, where he has left his stamp. In Burian is a chapel and a well of S. Dillo. The church of Landelleau, in the diocese of Qumper, honours him as patron, and claims to possess his relics. In the diocese of Dol his day was November 29. Another church dedicated to him is S. Thélo, in the old Pagus of Goello, now a deanery in the diocese of S. Brienc. Perhaps also Quillio, an adjoining parish on the opposite bank of the river Oust, may also be named after him.

In the text nothing is said of his having been one of the first companions with David in the establishment of his monastery at Rosina, the spot now called S. David's. The Bretons say that

his migration to Armonica was occasioned by the yellow plague, which wrought such devastation in Britain, and of which Maelgwn Gwynedd died in 560. After the cessation of the plague they say that he returned to Wales.

10

11 CEADMON, *Mk. Whitby*, circa A. D. 680 (L.).

12 RIOCH, *Ab. Brittany*, 6th cent.

Translation of S. FRIDESWIDE, V.M. Oxford.

ETHELWOLD, *B Lindisfarne*, A. D. 740 (L.).

RIOCH according to the legend, there were two Armonican chieftains, named Neventer and Derrian, who visited Palestine at the time when S. Helena was engaged on the search for the true Cross on Calvary. On their way home they came to Brezal, near Landerneau (Lann-Ternau), in Brittany, where they saw a man throw himself into the river. They hastened to rescue him, and found that his name was Elwrn, and that he was a chieftain. From him they learned that a ferocious dragon inhabited Brittany. The king, named Bristoc, who lived in a caer at Brest, had ordered that every Saturday lot should be cast among his nobles, and he on whom the lot fell was required to furnish one of his vassals as food for the dragon. The lot had fallen so often on Elwrn that he had given up all his subjects, and now was left alone, with only a wife and child of two years, and that, as the lot had again fallen to him, he had sought death in the river rather than see his child devoured. The two valiant men, Neventer and Derrian, offered to rid the country of the dragon if Elwrn would devote his son to religion. To this he gladly consented, and at once delivered up his two-year-old child to be educated to the ascetic life. The two brave men then went in quest of the dragon. Derrian threw his baldric round the monster, and bade the child, to whom the name of Rioch had been given, lead it to his father's castle. The monster was then thrown into the sea. At the age of fifteen Rioch or Rioc retired from the world to a rocky islet in the parish of Camaret.

Fragan, father of S Winwaloe, who settled at Plou-fragan, in the north of Armorica, visited the saint in his solitude, where he had lived on the islet for forty-four years, and he found him completely overgrown with red moss. Thus he scraped off, and found his skin fresh and white under it. Winwaloe took him from the island to Landewenec, where he died about 530. Cressy in his "Church History of Brittany" makes him a son of S. Darerca, "by nation a Briton, near kinsman to Patrick, by whom he was ordained a bishop in Ireland." But this is a different person, a contemporary of Bishop Ædus, who died in 589, and who visited Rioch in his monastery of Inis-bofinde, in Lough Ree. It is obvious that this abbot cannot have been the nephew of S. Patrick. There is confusion in the Irish accounts. There may have been two Riochs in Ernn, but both must have been distinct from the Rioch of Brittany.

- 13 DYFNOG, *C. Denbighshire, 7th cent.*
 MODOMNOC, *C. Ossory, 6th cent ; also October 11 (L.).*
 ERMINILDA, *Q. Abss Ely, circa A.D. 700 (L.).*

DYFNOG was the son of Medrawd, of the family of Caradog Freichfras. He is not the patron of the church of Defynog, in Breconshire, as is generally believed, for that church is dedicated to S. Cynog, the son of Brychan.

- 14 NECTAN, *B.M. Devon (see June 17).*
 15 BERACH, *Ab. Ireland, circa A.D. 615 (L.); also on February 18.*
 OSWY, *K. Northumbria, A.D. 670, see August 20 (L.).*
 16 TUDA, *B. Lindisfarne, A.D. 664.*

TUDA was one of those energetic Irish clergy who, after having travelled and been in Rome, enthusiastically embraced Roman usages, and laboured thenceforth to bring the Irish Church into conformity with Latin Christianity. He defiantly wore the semicircular tonsure, and his labours were in the south of Ireland, which was already nearly won to Roman customs, whereas in the north Celtic peculiarities remained. He was

ordained bishop, and went into Northumbria, where S Colman ruled, and observed the usages of his forefathers. When this latter saint, after the Council of Whitby, was forced to resign, because he would not submit, then Tuda was thrust into his place at Lindsfarne; but he ruled there for a short time only. He died in or about 664. See further, under Colman, February 18.

- 17 FINTAN, *Ab. Ireland, 6th cent.* (L).
 LOMAN and FORTCHERN, *BB. Ireland, 7th cent.* (L)
 GUEVROC, *Ab. Brittany, 6th cent* (see CURIG, June 16).
 FINAN, *B. Lindsfarne, A D. 661* (L)
- 18 COLMAN, *B. Lindsfarne, A D. 676*

COLMAN succeeded Finan as Bishop of Lindsfarne in 661. He was a Scot, and, like his predecessors, unyielding in his adherence to Celtic ecclesiastical usages. In the third year of his rule a synod was convened at Whitby. Oswy, the King of Northumbria, kept Easter according to Celtic custom, his wife, Queen Eanfleda, according to Roman computation. The difference had arisen out of a mistake. The Roman Church had re-settled Easter at a time when the British Church was isolated through the invasion of the Saxons; but the partisans of the Latin arrangement thought to humble the British Christians by heaping insulting epithets upon them, calling them quartodecimans and schismatics. The chief advocates of the Roman usage were Agilbert, formerly Bishop of the West Saxons, and S Wilfrid, whose arrogant and overbearing character has been described under the heading of his name (April 24). The principal supporter of the Celtic use was S Colman. Wilfrid had the best of the argument, though he used intemperate language, and threw aspersions on the memory of a far nobler and better man than himself, the great Columba. Oswy settled the matter in these words: "You both acknowledge that it was not to Columba, but to Peter that the Lord said, 'To thee will I give the keys of the kingdom of heaven,' and I tell you that he is a doorkeeper whom I am unwilling to gainsay, I desire to be obedient to his injunctions, lest, haply, when I come to the gates of the kingdom of heaven, there should be none to unlock to me, if he be out of humour who holds the keys." Oswy, in

fact, may have felt twinges of conscience because he had murdered Oswin, and, in his mean soul, hoped to obtain admission into heaven by thus winning the favour of its doorkeeper.

As Colman would not yield, he resigned his see of Lindisfarne; in fact, he was forced to do so, and, accompanied by the whole of his Scottish brethren, and about thirty attached monks of Anglican nationality, carrying the bones of S. Aidan, the apostle of the Northumbrian Church, he retired to Iona. It may have been that the house at Iona was unable permanently to maintain so large an addition to the community as was thus suddenly thrust upon it. At any rate, before long Colman removed with his monks to Ireland, and settled them in Innisboffin, the "island of the white heifer," situated two or three miles off the nearest point of the coast of Mayo, exposed to the storms and rollers of the Atlantic. After a while dissensions broke out between the Irish and English monks, the latter complaining that the Irish shirked the work of harvest by leaving the island in autumn to visit their friends. Colman solved the difficulty by buying a piece of land from a chief on the mainland, and building a monastery there for his Englishmen. This latter became an important settlement, and was known as Mayo of the Saxons.

Colman remained at Innisboffin till his death, which took place in 676.

- 19 ODRAN, *M. Ireland*, circa A.D. 451 (L.).
 BILFRID, *H. Lindisfarne*, A.D. 756 (see BALTHER and BILFRED, *March 6*)
- 20 OLCAN, *B. Ireland*, circa A.D. 500 (L.).
 MILDRED, *V. Abs. Thanet*, circa A.D. 700 (L.).
 WULFRIC, *P.H. Haselbury, in Dorsetshire*, A.D. 1154 (L.).
- 21
- 22 ELWYN or ALLEN, *C. Cornwall and Wales*, circa A.D. 420 (see *January 13*).

- 23 EARCONGOTHA, *V. Absb Faremousters, end of 7th cent*
(L)
MILBURGA, *V Absb Wenlock, in Shropshire, 7th cent.*
(L).
BOISIL, *Ab. Melrose (see January 13).*
JURMIN, *C Bury St Edmunds, circa A D. 750.*

JURMIN was of the royal family of East Anglia, and is said by some writers to have been a son of King Anna, but more probably his parents were Ethelhere, the brother of Anna, and S Hereswytha, the sister of S. Hilda. No particulars of his life are recorded, but his bones were translated to Bury St. Edmunds. Wilham of Malmesbury calls him Germinus, and says that he could learn nothing concerning him.

- 24 CUMINE *the White, Ab Iona, circa A D 668.*
ETHELBERT, *K. Kent, A.D 616 (L)*
LIUTHARD, *B. at Canterbury, 7th cent, see February 24*
(L. p 409), *also May 7.*

CUMINE the White, also called Cummian, was trained in the Columbian monastery of Durrow, in Queen's County. He went thence to Iona, with the abbots of which he was related by blood. He abandoned the Celtic party with regard to the Paschal controversy, and sent an epistle to the Abbot Segnius of Iona from the place to which he had retired, Disart-Chiamin, on the question. This epistle is a wonderful monument of Irish learning in that age, and at the same time throws much light on the events of the time. In it he refers to S Patrick as "papa noster." He mentions names of saints now become shadows—Ailbe of Emly, Kieran of Clonmacnois, and Brendan of Clonfert. And he puts the matter of controversy neatly thus: "What can be thought worse concerning the Church, our mother, than that we should say Rome errs, Jerusalem errs, Alexandria errs, the whole world errs—the Scots and Britons alone know what is right." He ridicules the claim of the Celts to set up for themselves, for, says he, "What are they but a pimple on the chin of the world." He wrote a Life of S. Columba, and in spite of his opposition to the Celtic use with regard to Easter, on the death of Suibhne (Segnius) was elected abbot of Iona. He died in 668.

25 WALBURGA, *V Abbs Heidenheim*, CIRCA A D 780 (L).

26 TYFAELOG, *C. Brecknockshire and Carmarthenshire*, 6th cent.

TYFAELOG was a son of S Gildas, and grandson of Caw. He founded churches in Brecknockshire and Carmarthenshire.

27 ALNOTH, *H M Stowe, in Northamptonshire*, CIRCA A.D. 727 (L).

28 LLIBIO, *C. Anglesea*, 6th cent.

LLIBIO was one of the sons of Seithenn, who, with his brothers, after the overwhelming of the plain of Gwyddno by the sea in the sixth century, became saints in Dunawd's monastery of Bangor, by the banks of the Dee.

MARCH

I DAVID, *B. Menevia, in Wales*, CIRCA A.D. 562 (L.)

MONAN, *C. Ireland*, A D 571

MARNAN OR MARNOCK, *B. Scotland*, A.D. 625.

MONAN, *Archd St Andrews*, CIRCA 874 (L).

SANNAN OR SENANUS, *Ab. Wales (see March 8)*

DAVID The beautiful shrine of S David remains intact in the choir of the cathedral. A recent discovery is of great interest. During the restoration of the lady chapel and ambulatory, between it and the choir a recess was discovered behind the high altar, walled up and plastered over, that contained human bones. This recess was formerly lighted by a beautifully worked and ornamented small circular Norman window opening into the church, about four feet above the floor. There can exist little doubt that these relics were those of the patron saint, which could be seen and touched through the tiny *fenestella confessionis*. At the Reformation it was plastered over and concealed. The relics on their discovery were placed in a box

and buried in the churchyard. They certainly ought to have been placed in the empty tomb in the choir; but those who made the discovery were not at all aware what the signification of the position of the bones was, and consequently whose they were. His death is variously placed at 544, 562, and 601.

MONAN or MOINEN was suffragan-bishop to S Brendan of Clonfert. He is spoken of as tall and fair, and he is in all likelihood the same Monan who came with S Brendan to Clonfert when quite a youth; he afterwards went, according to Scottish tradition, to Fife, but the Scottish legend concerning him is fabulous.

MARNAN or MARNOCK was a bishop in Scotland, and is thought to have been the same with Ernans, a boy who sought to touch S Columba's garment at Clonmacnois, and whose future greatness was predicted by the saint. But in the Irish calendars his commemoration is on August 18. Formerly it was customary to wash the head of the saint at Aberkeidner every Saturday, and give the water to be drunk by those who were sick and suffering. His death took place about 625.

2 FERGNA *the White*, B. Scotland, A.D. 622

GWRTHWL, C. *Brecknockshire and Carmarthenshire*, uncertain date.

CHAD, B. *Lichfield*, A.D. 672 (L.).

JOAVAN, Ab. B. *Brittany*, circa A.D. 553 (L.).

FERGNA *the White* was an Irishman, and a kinsman of S. Columba, and from his earliest youth he was under his direction at Iona. He returned to Ireland, and dwelt at Clon-genevil till the death of Columba, which was miraculously communicated to him. Upon this he went to Scotland, and led a hermit-life, first in one island then in another. He was afterwards made abbot of Iona, and was a bishop. He died in 677.

JOAVAN, whose life is given in the text, was son of a sister of S. Pol de Léon, or Paulus Aurelianus, and was grandson of Porphyus (Porphyrius?) Aurelianus, probably a Romano-British family. His brother is called in the legends Tinidor, but this is Tighernach-daor. He was with his uncle at the college of S. Illtyd, at Lantwit Major, but seems to have been much in Ireland, and his father appears to have been settled there. He followed his uncle Paul to Brittany, and became abbot of Daougias, where two abbots, Judulus and Tadeo, had been

murdered by a petty noble called *Fao*. He succeeded in converting this chieftain, and baptized him. When *S Paul* resolved to surrender his bishopric and abbacy at *Léon*, *Joavan* was chosen as his successor, but held the bishopric and abbacy for a year only, and died in or about 553.

On the ground of *Joavan* or *Jaovan* being supposed to be Irish, *Colgan* has admitted him among the saints of the island on March 2, the day on which he is venerated in Brittany.

3 NON, *Mother of S. David, W. Wales and Cornwall,*
— circa A.D. 540

WINWALOE, C Brittany and Cornwall and Wales, 6th cent (L.)

NON or NONNITA, the mother of *S. David*. She was the daughter of *Cynr* of *Caer Gawch*, a rude fortified camp on one of the headlands of *S Davids*. He was but a petty chief. *Ceredigion* or *Cardigan* lay to the north, governed by *Sandde*, grandson of *Ceredig*, of the house of *Cunedda*, who gave his name to the district. *Sandde* happening one day to see *Non* in the fields, seduced her.

She retired to a little dwelling near *Porth Cleis*, on the slope of the downs, above the purple crags that plunge into the sea. Here was a pleasant spring, and here, facing the sun, she remained till she bare a child, which was in the midst of a thunderstorm. It is told that in her pains she lay under a great standing stone, a menhir, and that this was split by the lightning, and one portion was whirled over her head and fell and planted itself erect at her feet. Yet she was in no way injured. She had leaned her hands against the stone, and left the impress on them in the hard rock. This stone was afterwards laid as the foundation of the altar, when a chapel was erected on the spot. This chapel remains, and is ruinous. It points north and south, and has an early incised cross on the east side. The lower portion of the south wall is of very rude and primitive masonry, to the height of about six feet, built without mortar. Were the rubbish cleared away and this interesting chapel excavated, the marvellous stone with the impress of her hands "like wax" might be found.

When *S. David* was born he was taken to *Porth Cleis*, where he was baptized by the Bishop *Beluc* in a well that is still known as the place where *S. David* was made a member of the kingdom of God.

The Lives of S David expressly tell us that his mother was outraged by violence, and that otherwise "she continued in chastity of body and mind, and led a most faithful life"

We know very little more of her. It would seem that she accompanied her son on his journey at least to Cornwall and Devon, for we have there two churches of her foundation, Altarnun and Bradstone. At the former was a marvellous well that fed a tank into which mad persons were precipitated backwards, and this was believed to recover them. The tank is now filled, and the spring has drained away at a lower level. At this place there was a sanctuary attached to her foundation. Not far away is Davidstowe, a church under the invocation of her famous son.

At Bradstone is a large slab, the quot of a cromlech, the supports of which have been removed. A local tradition says that she was martyred on this stone by the Druids, but there is no authority to support this story. What is possible is, that she may have been instrumental in the destruction of this monument.

At S. Cuby, in Cornwall, is an interesting inscribed stone in the foundation of the tower bearing the names of Nonnita, Ercilius, and Virigatus, but it can have no relation to our saint. Owing to her name being Non or Nonna, the notion grew up that she was by profession a nun, who had been violated by Sandde.

Where Welsh history fails us, there Breton legend takes up and completes the story.

According to the miracle play of S Nonna, which was at one time extant at Dinnon, a parish in Brittany, of which S Non is patroness, and where this Breton play was at one time annually performed, the mother of S. David was also named Melaria. She crossed over from Cornwall to Brittany, and found a retreat at Dinnon, where she remained to her death. There the rock is shown on which she was wont to kneel in prayer, till she had left therein the impress of her knees. In the church is her tomb of the thirteenth or fourteenth century, representing her trampling on a dragon, and holding a book in her hands. Dinnon is near Lanternau, south of the Elorn River, on the opposite bank is S Divy, dedicated to her illustrious son.

WINWALOE must have founded several churches in Cornwall. He is patron of Landewednac and Tremaine, Tresmere, Gunwallo, and he had a chapel at Cradock, in S Cleer.

His connection with Cornwall is due to this, that he was the son of Fragan and Gwenteirbron. Fragan was cousin of Cado, "King of Britain," and Fragan fled to Armorica in the latter part of the fifth century. According to Welsh genealogies, the

husband of Gwenteirbron was Æneas Lydewig, and by him she was mother of S. Cadfan. Fragan must have been a second husband. His kinsman Cado was the Duke of Cornwall, son of Gerant, who fell at Llongborth. This being the case, he was probably son of Erbyn, Prince of Devon, who died about 450. Winwaloe's cousin would accordingly be S. Selyf or Solomon, Duke of Cornwall, and also of Breton Cornouaille, and he would be akin to S. Cybi. This relationship at once explains the numerous foundations of Winwaloe in Cornwall. At Gunwalloe his holy well is choked with drift sand. There his feast is on the last Sunday in April. In Devon the parish church of Portlemouth is dedicated to him, under the name of S. Onolaus.

4 GISTLIAN, *C. Wales, 5th cent.*

OWEN, *Mk. Lavingham, end of 7th cent. (L.)*

ADRIAN, *B.M. St. Andrews and Comp., MM. Scotland,*
circa A.D. 870 (L.)

GISTLIAN was a son of Cynyl of Caer Gawch, a chief who occupied a walled caer or fortress on one of the porphyry and purple-red Cambrian headlands above S. David's Head, the remains of which stronghold are visible to this day. Gisthan was brother of Non, mother of S. David, and of Gwen, mother of S. Cybi. Gisthan, or Justhanus, established a monastery at Hên Fynyw, which was the old Roman Minevia, the site of which has not been determined with accuracy, but which is probably covered by the sands that are heaped up in the lap of Whitsand Bay, and are overrun with low growing yellow roses. To this point the old Roman road, the Via Julia, leads, but so far no traces of the ancient settlement have been discovered. Here Gisthan ruled as abbot and bishop. When S. David arrived in Menevia, after having been trained by Paul Hên, or "the Aged," and had founded churches in many places, he saw in vision an angel, who informed him that old Menevia, or "The Bush," was not a suitable site for a monastery, for that from it scarce one in a hundred would be saved, whereas the glen of the Alun, the Glyn Rhosyn, was so good, that every one buried in its cemetery would be certain to obtain mercy. Thus he related to his uncle, who thereupon shifted his quarters to the more favoured spot. If we translate this marvellous story into plain English, we should say that common-sense had spoken to S. David, and

told him that it would be far better to establish a college in a sheltered valley, where there was good soil with abundant water, than on the edge of the sea, exposed to the furious gales from the west, where the sand was ever shifting, the soil was naught, and there was no spring water Gisthan died in the sixth century.

- 5 KIERAN OF SAIGIR, *B Ossory, in Ireland and Cornwall*, CIRCA A D 552 (L).

JACUT, GWETHENOC, *Abbs.*, and CREIRWY, *V Brittany*, 6th cent.

CARON, *B. Cardiganshire*

KIERAN. The oratory and cell of the saint, which were overwhelmed with sand many centuries ago, were discovered and dug out in 1835 by Mr. William Michell of Comprigney, near Truro. A description, accurate and precise, of the church as found by him is printed in Prebendary Hingeston-Randolph's "Register of Bishop Grandisson" (Lond, 1897, p 608) In 1844 the Rev. William Haslam, then curate in charge of the parish, published a book, in which he gave an account of its "discovery and restoration" Previous to this the Rev. C Collins Trelawny published "Perranzabulo: the Lost Church Found," which went through seven editions (1837-72). Neither of these writers saw the church in its original state, and owed much to Mr. Michell's account. In 1880 Mr Haslam returned to the subject, in a book entitled "From Death to Life," and quietly appropriated the discovery to himself. Not only did Mr Haslam do this, but he undertook mischievous "restoration," that is to say, adaptations to his own fancies The altar was found north and south. Mr. Haslam, taking it for the tombstone of S Kieran, erected it east and west over the body of the saint, and placed a new granite slab on top, inscribed S. Piranus Three skeletons had been found by Mr Michell, with their feet only under the altar. Mr Haslam pretended to have discovered the skeleton of S Piran himself Small reliance can be placed on his statements; the only trustworthy account is that by Mr Michell, which must be read where indicated.

JACUT, GWETHENOC, and CREIRWY, according to the legendary life of S Gwenoleus or Winwaloe, were born in one day of one mother, S. Gwen. Their father was Fragan or Brychan, but not he of Brecknock This couple migrated to Armonica from Britan at the close of the fifth century The three

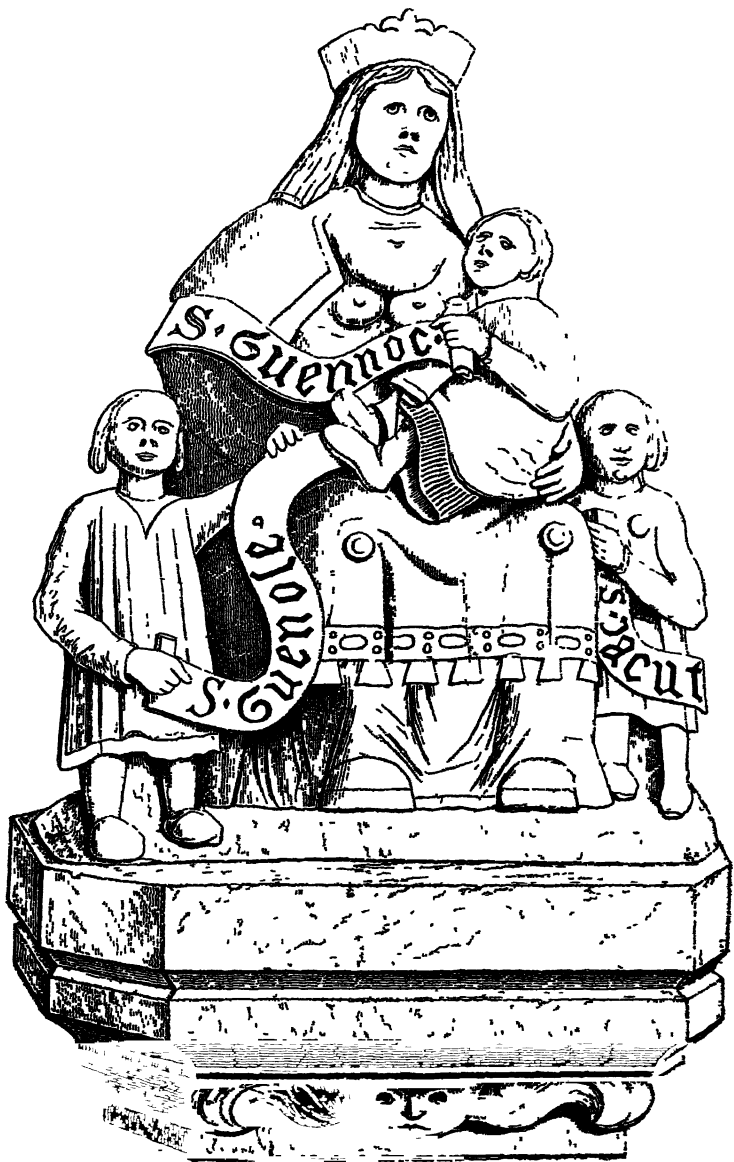

SAINT GUENN AND HER THREE SONS.
Monument in Brittany

brothers, Jacut, Gwethenoc, and Winwaloe were educated by S Budoc Their names are not known in Wales, but they are famous in Brittany Their mother had three breasts, and she was able to suckle all three simultaneously. Some curious representations remain of the three-breasted Gwen. When grown to man's estate the brothers retired into solitary places, and Jacut and Gwethenoc found rest for their souls in the island of Landouart The ancient kalendar of S M'cen gives March 3 as the feast of S Jacut, but in the dioceses of S. Brieuc and Dol he was commemorated on March 5 Creirwy was the sister, and she also led a solitary life. Jacut, along with Winwaloe, was a disciple of S. Corentin. One day when Creirwy was driving geese out of the yard one of the birds flew at her, pecked out and swallowed her eye Winwaloe killed the goose, opened its crop, took out and replaced the eye, and his sister thenceforth saw as well as before A more famous brother than Winwaloe was S Cadfan; but the Welsh accounts give Æneas Lydewig as the husband of Gwen of the Three Breasts, and not Fragan It is, however, possible that Gwentierbron was twice married, and that Cadfan was son by one husband, and the three commemorated to-day were by the other, as also S. Winwaloe.

CARON, a bishop, who founded the church of Tregaron, in Cardiganshire. His date is unknown.

- 6 *Translation of SS. KYNEBURGA, W. Abs., KYNESWITHA, V. Abs., and TIBBA, V at Peterborough, end of 7th cent. (L.).*

BALTHER and BALDRED, *H H. Tunningham, in Northumberland, A D 756 (L.).*

- 7 DEIFER, DIHEIFYR, or DIHAER, *C Flintshire, 6th cent. EASTERWIN, Ab. Monkswearmouth, A.D. 785*

DEIFER, DIHEIFYR, or DIHAER was a son of Arwystli Gloff, or "the Lame." His brother was Tyfrydog, and his sister S Marchell, foundress of the cell that became later the abbey of Strata Marcella. They belong to the sixth century. He founded Bodfan, in Flintshire.

EASTERWIN, a kinsman of Benedict Biscop, became a monk of Wearmouth, and although of noble blood, he held the plough,

and worked in the mill and at the forge He had an open, pleasant countenance Whilst Benedict was away, Easterwin ruled the establishment He was seized with his last sickness whilst Benedict was in Rome, and he died in 686.

- 8 SENAN of *Innscathy, B. Ireland*, circa A.D. 546 (L).
 RHIAN, *Ab. Pembrokeshire*, date uncertain
 FELIX, *B. Dunwich*, A.D. 654 (L).
 DUTHAC, *B. Ross*, A.D. 1253 (L).

SENAN In the text I have said that I suspected that the S. Sanç venerated in Brittany, at Plouzanç, was a different person from the Bishop of Innscathy I no longer hold this opinion I think that there can be little doubt that the S. Sennen who built a church at Land's End, Cornwall, was Senan of Innscathy The Bieton legend clearly identifies the abbot who settled at Plouzanç with this famous Irish saint, and he is commemorated in Brittany on the same day as in Ireland The church of S. Senan, at the Land's End, is dedicated to him; so, perhaps, was Zennor, but it is reputed to be named after a female saint, Senara.

RHIAN is called by William of Worcester (*Itin* p. 164) "S. Ranus, abbas"; and by Leland (*Itin* v. 29) "S. Reanus, abbas" He lived in Pembrokeshire, where he founded Llanrhan

- 9 CONSTANTINE, *K.M. Cornwall; also March 11* (see below)
 BOSA, *B. Northumbria*, A.D. 705 (L).
 MERIN, *6th cent.*, see *January 6*, and GWYNHOEDL, *January 1*.
- 10 KESSOG or MAKESOG, *B. Ireland and Scotland, 6th cent.* (L)
 FAILBHE *the Little, Ab. Iona*, A.D. 754
 FAILBHE the Little, abbot of Iona from 747 to 754, died at the age of eighty.
- 11 CONSTANTINE, *K.M. Cornwall and Scotland, circa A.D. 576 or 600* (L.), see also *March 24*.
 ÆNGUS OF KELD, *B. Ireland, circa A.D. 824* (L.)

- 12 PAUL, *B. Léon, in Brittany*, A.D. 573 (L)
 GREGORY *the Great, Pope, Rome*, A.D. 604 (L)
 MURAN, *Ab. Fathinnus, Ireland*, circa A.D. 650 (L)
 ALPHEGE *the Bald (the Elder)*, B. A.D. 951, also
September 1.

Paul, Bishop of Léon. The Life by Wmonoc has been published by Dom Plaine in the *Analecta Bollandiana*, 1882, vol. 1. pp. 208-58, and by M. Charles Cuissart in *La Revue Celtique*, vol. v (1883), the first from a Paris, the second from a Fleuri codex, and this is a great acquisition, as the Life given in the Bollandists was unsatisfactory. Wmonoc wrote in 884, but admits that he had an earlier life to go upon.

Paul's father was Porphus, a Romanised Briton, and he was born at Cowbridge, in Glamorganshire. He had eight brothers and three sisters. Among the latter was Sativola or Sidwell. We learn the names of the rest from other sources, S. Wulvella and S. Jutwara.

In Cornwall he founded Paul's, near Penzance, and he is also patron of Ludgvan. Between these two churches is Gulval, of which his sister Wulvella is patroness.

- 13 MOCHOEMOG, *Ab. Liathmor, Ireland, middle 7th cent.*
 (L).
 KENNETHA, *V. Scotland*
 GERALD, *Ab. B. Mayo, circa A.D. 700.*

KENNETHA or KEVOCA is really Caomhan or Mocoemog, Abbot of Liathmor, in Tipperary. The history of the life of this saint having been lost in Scotland, by a curious blunder he was converted into a female virgin saint, and as such appears in Scottish calendars.

- 14
 15 CONLAETH, *B. Sodor, circa 520.*

CONLAETH was the hermit selected by S. Bridget to be her chief artist, and she associated him with herself in the government of her monasteries. She set him to read aloud to her.

nuns whilst they were at their meals He is variously called Conlaith, Conlaed, and Conlian He was a bishop, and he drove in his chariot to call on S Bridget, when she was so pleased with his piety that she retained him. He became first bishop of Kildare This can hardly have been before 490 He is thought to have died about 520.

16 COLUMBA, *V.M. Cornwall (L.)*.

FINAN *the Leper, Ab. Swords and Innisfathen, Ireland,*

CIRCA A D. 610.

BONIFACE QUIRITINE, *B. Ross, in Scotland, 7th cent (L.)*.

FINAN OR FINIAN THE LEPER was born in Ireland, in Ely O'Carrol, and of an illustrious family. Being desirous of perfection, he took on himself the leprosy of a child who came to him to be cured, and sent the child away healed He became a disciple of S Columba He was most desirous to visit Rome, but was forbidden by the saint. Thereupon Columba, to mitigate the disappointment of the man, bade him lay his head in his lap. Finan did so, and when he awoke was able to give a graphic description of the Eternal City, which he had visited in dream Maggots bred in his sores, and these he termed his good mates; but after thirty years he was cured.

Whether Finan, who was abbot of Swords, is the same as Finan the disciple of Columba, is doubtful Two other monasteries are attributed to him, Innisfathen and Ardfinan, "the high place of Finan," in Tipperary. But almost certainly these are quite distinct persons The disciple of Columba died about 575, and the Abbot of Swords is held not to have died till later According to the legend of Finan or Fintan Munnu of Taghmon (*see October 21, L.*) this saint was also a leper. The Irish saints seem to have passed on their complaints as well as the miracles they wrought from one to another Fintan died in 625

17 PATRICK, *Ap. Ireland, A D. 465 (L.)*.

BECAN, *H Iona, A D 675*

WITHBURGA, *V. Dereham and Ely, A D. 743; also July 8 (L.)*.

- 18 FINNIAN OF FRIGIDIAN, of Moville, in Ireland, B. Lucca,
 A D 589 (L.)
 COMMAN, C Tyrconnel, A D 688.
 EDWARD, K M. Wareham, A D 978 (L.).

- 19 CYNBRYD, M. Denbighshire, 5th cent.
 LACTEAN, Ab Ireland, A D 622 (L)
 ALKMUND, M Derby, A D 800 (L.)
 CLEMENT, B Dunblane, A.D 1258

CYNBRYD, one of the many reputed sons of Brychan He founded the church of Llanddulas, Denbighshire, and was slain near it by the Saxons at a place called Bwlch Cynbryd, or Cynbryd's Pass

CLEMENT, Bishop of Dunblane, introduced the Dominican order into Scotland He had received the habit at the hands of Dominic himself Foidun tells us that he was a famous preacher, and that he had great facility in acquiring languages, also that he was a man mighty in word and deed before God and man. He found the church in Dunblane in a deplorable condition of neglect It had been impoverished by his predecessor, and the divine mysteries were celebrated in the cathedral only thrice a week, like a country chapel He laboured to restore the dignity of divine worship, and to rebuild his cathedral

- 20 CUTHBERT, B. Lindisfarne, A D. 687 (L.)
 HERBERT, H P Derwentwater, A.D 687 (L.).

- 21 ENDA, Ab Aranmore, circa A D 540 (L.).

- 22 FAILBHE I., Ab Iona, A.D 679.
 THOMAS OF LANCASTER, M. Pontefract, A.D 1311 (L.).

FAILBHE I was of the noble race of Conall Gulban, in Tyrconnel. Finan, Abbot of Rath, was his brother, and Iona was recruited from this stock; the headship of the abbey was

for long hereditary in the family of Columba Failbhe became abbot on the death of Cumin in 668, and was succeeded by Adamnan in 679. He twice revisited Ireland, probably in connection with the Paschal controversy.

- 23 FINGAR OF GWINGAR, *M.*, and PIALA, *VM Cornwall*,
circa A.D. 520 (L).

MOMHAEDOC, *Ab Ireland*, circa A.D. 600

ETHELWOLD, *H Farne*, circa A.D. 723 (L)

FINGAR and PIALA. Fingar is also known as Gwingar or Wyn-car. In Brittany he is commemorated on December 14. Not only does a parish bear his name, but also a chapel in the cathedral of Vannes, and another at Pluvigner, where some of his relics are preserved. His festival is observed as a double; and he is regarded in Brittany as having been a bishop. S. Piala, his sister, was the original patroness of Phillack, in Cornwall. Later clerics changed the dedication to S. Felicitas.

In the text I have said that the Theodoric of the Acts is probably Corotic, but it is more probable that he was the Tewdric, a petty prince of Cornwall, who appears repeatedly as a tyrant. Tewdric had his *Llys* or Court in S. Kevern parish, and a palace on the Fal, as we learn from the Acts of S. Kea, at a place now called Goodern (Gwydd-tiern). If Tewdric were, as I suspect, the son of Budic of Domnonia, then his date would be about 510-26.

- 24 CONSTANTINE, *K M. Cornwall and Scotland*, circa 600,
see below, and March 11 (L).

DOMANGART, *of Sheve Donart, B. Ireland* (L)

HILDELITHA, *V. Abss. Barking*, circa A.D. 720 (L)

DUNCHAD OR DONATUS, *Ab. Iona*, A.D. 716, *also*
May 25

CONSTANTINE. According to the legend, he was son of Padarn, King of Cornwall, but this is a mistake of the Latin scribe. His father was Cadwr,¹ Duke of Cornwall, reputed to

¹ Cadwr may have become Padwr, just as the Goidelic Cieran became the Brythonic Pieran, and the monkish writer latinised Padwr into Paternus.

be a cousin of the renowned King Arthur. Harding, in his "Metrical Chronicle," says—

"Duke Cador's sone, of Cornwall bounteous,
Afore had been one of the table rounde
In Arthures time."

It is pretended, but this is mere fable, that after Arthur had received his death-wound on the field of Camlan he nominated Constantine to be his successor, and the British forces continued for several years under his command to make stubborn resistance to the Saxons. It was against him that Gildas launched his ferocious letter in 547. He styles him, "the tyrannical whelp of the unclean honess of Devon." Why he should have cast this insulting epithet at the mother of Constantine is not known. Her name is unrecorded, but it was part and parcel of Gildas' manner to throw dirt against every one, especially such as were of his own race and family. He accused Constantine of murder and sacrilege, because he had killed two youths who had taken sanctuary. The traditional account of the circumstance is as follows—The youths were the sons of Mordred, who laid claim to the throne and stirred up rebellion against him, and made common cause with the Saxon foe. After several battles the rebels were defeated and put to flight. One of the youths fled to Winchester, and took refuge there in the church of S Amphibalus, but was killed by Constantine before the altar. The other escaped to London, was captured in a monastery, and put to death. That there is a foundation for this legend is probable enough; in fact, Gildas shows that Constantine did kill two youths, kinsmen, and it is probable enough that he was justified in so doing. They were traitors to the national cause. What angered Gildas was, not that they were put to death, but that they were put to death sacrilegiously. Gildas says—"Not one worthy act could he boast of previous to this cruel deed; for many years before he had stained himself with . . . many adulteries, having put away his wife. For he had planted in the ground of his heart a bitter scion of incredulity and folly, . . . watered with his vulgar domestic impieties," &c. Not much weight can be placed on the words of this scurrilous writer, matched only by the coarse and indecent pamphleteers of the later Georgian age, but we may allow that Constantine was not a very virtuous prince.

In 588 or 589 he was converted, according to the Irish and Cambrian Annals.

The story of his conversion is told in the Life of S Petroc¹ Constantine was hunting near Bodmin, when the stag he was pursuing fled to the hermit's cell, and took refuge at his feet Constantine coming up, purposed to kill the stag, but his purpose failed when he saw how that the innocence and holiness of the solitary were recognised even by dumb animals He entered into himself, and repented of his disorderly life (See the story in the Life of Constantine, March 11, p 214) But, on the other hand, we are told that the real motive of the conversion of Constantine was grief at the death of his wife This does not agree with what Gildas says, but it is not improbable that he may have been reconciled to his wife after a temporary separation, and have loved her better than he did before. The Aberdeen Breviary informs us that this was the true motive of his conversion, and, further, that his wife was an Armorican Princess

So completely did he sever himself from the world, that it was supposed by some that he had been murdered by Conan, his successor

But he retired to a cell on the sands in the parish of S Merryn, near Padstow, where was a well, and where he could be near Petroc, through whom he had been brought to the knowledge of himself. S Cadoc may have been hard by at the time; he was a Welshman, and Petroc possibly may have committed to him the direction of the contrite old king The other churches founded by Constantine are one in the deanery of Kerner, on a creek of the Helford River, and Milton Abbot, in Devon, on the Tamar These were probably dedicated by him before his conversion, as we do not hear of him having been long in Cornwall after this event Had he continued in his native land, moving from place to place, the rumour that he was dead could hardly have spread. At the same time, it is possible that after having resided a while in S Merryn he went to the Helford estuary, settled there for a while, and then, as Conan, prince in his room, objected to his presence in Cornwall, he moved across the Tamar into Devon, and then, that being inconvenient, he betook himself to Menevia, and placed himself under the direction of S. David. In the Life of S. David we read that Constantine, on his conversion, came to the monastery in Menevia, "and submitted his stubborn neck, which had never before been bridled, to the yoke of humility in the cell of

¹ I assume that the Constantine of the Life of S Petroc is one with the King of Cornwall.

this father, and there he remained a long time performing faithful service " It is difficult to reconcile dates here, as David died before this

From Wales he removed to Ireland, "and there for the love of Christ," relates Hector Boece, "he laboured for some time in the service of a miller, disguised as a poor man, till at length he was induced by a monk, to whom he made himself known, to shave his head, and devote himself to a religious life in a monastery, where he lived with such piety and devotion, that he became a pattern of all virtues to the rest of the monks, and, after some time, was sent by the bishop of that place to instruct the people of Scotland in the faith of Christ." There he founded the church of Govan, on the Clyde, and was buried there.

Doubts have been cast on the identity of the Cornish Constantine with the saint of that name who toiled and died in Scotland at the close of the sixth century. But all the best authorities concur in describing the Scottish Constantine as the son of Cadur, Duke of Cornwall. The notice of his conversion in the Irish Annals points to his having been known in Ireland, and when we find that both in Cornwall, Scotland, and Ireland his festival is observed on the same day, March 11, it is hard not to conclude that the same man is commemorated. That he should have wandered about so much is quite in accordance with the practice of Celtic saints, who were possessed with restlessness that never allowed them to remain long in one place.

In the text (March 11) I have adopted the legendary life as basis, and given his death as occurring in 576; but if he be, as is probable, the Constantine converted in 589, then his death cannot be put earlier than just before 600.

DUNCHAD succeeded Dorben as abbot of Iona in 713. He was son of Kenfoelaid and grandson of King Malcov, or Moelcova, consequently was of the Columban family, and inherited the abbacy according to the law that constituted the headship, an office to which one of the family had a hereditary right. He had been an abbot at Kill-lochuir, in Ulster, before he succeeded to Iona. He was abbot when Egbert arrived from Ireland and induced the monks to receive the Roman Paschal cycle, and tonsure. Thenceforth Egbert continued to reside at Iona until 729. Dunchad did not live long after obtaining the abbacy of Iona, for he died in 716, on May 25, the day on which his festival was usually kept; but in Scotland his day is March 24.

- 25 CAMIN, *Ab Inneskeltra, Ireland*, A D 653 (L.).
 ALFWOLD, *B. Sherborne*, A D 1075 (L)
 WILLIAM, *child M. Norwich*, A.D 1141 (L)
 ROBERT, *child M. Bury St. Edmunds*, A D 1181

ROBERT, a child found murdered at Bury, and this furnished a convenient excuse for pillage and butchery of the Jews, A D 1181.

- 26 MOCHELLOC, *Ab. Ireland, beginning of 7th cent.*
- 27 TYFEI, *M Pembrokeshire and Carmarthen, early 6th cent*

TYFEI was the son of Budic, an Armorican prince, and Arianwedd, the sister of S. Teilo. Whilst a child, he was accidentally killed in the early part of the sixth century, and the popular voice has proclaimed him a martyr. He owes his admission into the Kalendar to his having belonged to a princely and saintly house. His brother was S Ismael, who was a favourite disciple of S. David. In Dynevor Park, under the shelter of the hill, overhung by noble trees, nestling into a warm corner, with the meadows of the Towey before it to the south, is the little church of Llandyfeisant, dedicated to him, and probably the scene of his "martyrdom." He was, however, buried at Penally, in Pembrokeshire. Soon after, Budic, who had come to Wales from Armorica, returned to it, and became there the father of S. Oudoc, afterwards Bishop of Llandaff.

28

- 29 GWYNLLYW FILWR OF WOOLOS, *K.C. Monmouthshire, circa 520.*

GUNDLEUS or GWYNLLYW FILWR (the Warrior), now known as S. Woolos, was a prince of South Wales, son of Glywys, of the line of Cadell Deyrnllwg. The kingdom was called Glywysig, and comprised a portion of Monmouthshire and of Glamorgan. On the death of his father the sons divided up the kingdom among them, and Pedrog (Petroc) alone went short, but he had professed the religious life. But according to the

Welsh pedigrees Petroc was son of Clement, who may have been uncle of Gwynllyw.

The portion that fell to Gwynllyw was the marshy district now called Wentloog level, between Newport and Cardiff, but running back to the feet of the mountains. His residence was on the height near where now stands S. Woolos's Church, Newport, commanding a splendid prospect of his marshy territory, with the glittering Severn estuary beyond. The Caldecott and also the Wentloog levels had been reclaimed by the Romans, and the second legion, stationed at Caerleon, had banked out the tide, but since the legion had been withdrawn, doubtless all had reverted to swamp.

Gwynllyw fell in love with a granddaughter of Brychan of Brecknock, named Gwladys, and sent to ask her hand, but the king, her father, treated the messengers with contumely. "She enjoyed a high reputation, was elegant in appearance, beautiful in form, and wore silk dresses," says the Life of S. Cadoc.

Gwynllyw, highly incensed, armed three hundred of his men and swooped down on Talgarth, in Brecknock, where the damsel was, seated her behind him on his horse, and galloped away with her. The king, her father, pursued, and a fight took place at Rhw Carn, near where now are the Beaufort Ironworks, and where were the confines of the territory of Gwynllyw. In this fight several hundred lives were lost. According to the story, it would have gone ill with the ravisher had not King Arthur, who happened to be near, come to the rescue.

We possess in addition to this account given in the Life of S. Cadoc another, a Life of S. Gwynllyw, written to glorify him, and it is instructive to see how the biographer altered facts to suit his ideas of what ought to have been. In this latter document the story of the marriage reads very differently. "When by the general advice of the inhabitants he desired to get married, he sent ambassadors to Brychan, king of Brycheiniog, for he had heard of the gentleness and beauty of his daughter Gwladys, she being requested as a bride was promised, and given that he might enjoy legal nuptials." Not a word about the elopement.

So, on the same authority, we learn, "When Gwynllyw reigned, all the inhabitants were obedient to the laws, no one then dared to injure another. Peace was confirmed, there were no contentions in his time, he was a pacific king." But when we turn to the Life of S. Cadoc we have another account altogether. "On a certain night some of Gwynllyw's thieves went for the purpose of committing a robbery to a town wherein dwelt a religious

Irishman, who was a hermit, and devoutly served God. *These thieves the aforesaid Gwynllyw loved, and incited to robbery*" And again: "Cadoc's father, the aforesaid Gwynllyw, was given up to carnal allurements, and frequently instigated his soldiers to robbery and plunder, and he lived contrary altogether to what was just and right, and disgraced his life with crimes" This was, of course, in his unconverted days, but this is a fair instance of the manner in which some of the monastic biographers not only evolved the lives they wrote out of their inner consciousness, but even deliberately altered or suppressed facts that did not comport with their ideas of what the saints should have been. But at a much later date Alban Butler did the same. These unscrupulous hagiographers wrote for edification, and not as historians.

In one point both biographers are agreed, in the goodness of Gwladys, and her readiness to lead a holy and self-denying life, in her eager response to the call of Divine grace.

When Gwladys was in a fair way to become a mother, four lamps shone miraculously every night, one in each corner of her chamber. This is merely a hagiographer's way of saying that she liked to keep a light burning in her room at night. Her eldest child was called Cathmael, afterwards known as S. Cadoc.

This child was the precursor of a large number of brothers and sisters. When the couple had their quiver as full as possible, it occurred to them that it was high time for them to think of their souls. The legend says that this thought was prompted by an angel, who told Gwynllyw to build a church at a place where he saw a white ox with a black spot between the horns.

According to the Life, Gwynllyw and his wife thereupon went in search of the spot, and the king made over his principality to S. Cadoc. Probably he did nothing of the sort, but built a church of wattles, within a bowshot of his caer or fortified residence. And this spot is that where now stands S. Woolos's Church.

He and his old wife lived on in their fortress, a furlong distant, and they fasted together, bathed together in the Usk when the tide was up, and sometimes when the tide suited bathed twice a day. When S. Cadoc became a saint and abbot at Llancarvan he disapproved of the old people tubbing together, and remonstrated. They could not understand his scruples, but he insisted, and, convinced against his will, Gwynllyw suffered his imperious son to remove the old woman to a distance—

within an easy walk—and build her a separate cabin, and enjoy on her a little less publicity in her bathing arrangements

In his last sickness Gwynllyw was visited by his son and by S. Dubricius

The form of religion—repeated bathing—seems to have struck the mediæval Latin monks with astonishment, so unaccustomed were they to cleanliness, and they considered it explicable only as the severest form of self-imposed asceticism. In this particular the Celtic saints towered above such as S. Thomas à Becket, who, when dead, was found to have his inner vestment “boiling over” with vermin; towered above the biographer of Becket also, who could admire such filthy habits

In a field within a short distance of the church of S. Woolos “there was not long ago,” writes Mr C. O S Morgan in the *Archæologia Cambrensis* (1885), “a moated mound, on the summit of which was planted a clump of fir-trees. There are several of these mounds about the country. They consist of a circular conical mound, having a flat table-top, usually about fifty feet in diameter, and surrounded by a deep fosse or moat. The summits are always flat. This mound is now in the grounds of Springfield, laid out by the late Mr. Gething. It is, however, no longer a mound, but is buried up to the top with the spoil brought up by the shafts during the excavation of the tunnel of the Great Western Railway, which runs underneath. Its site, however, is still marked; for, in order to preserve it, as the fir-trees were all cut away, I suggested to Mr Gething to collect the large masses of rock brought up out of the tunnel and place them in the form of a cairn on the summit of the mound. This mound used to be called ‘The Grave of S. Woolos’, but that was incorrect, as these mounds were not burial-places, but the dwellings or strongholds of the chieftains or rulers of the district, and in subsequent times were converted into castles by the erection of stone edifices on their summits in lieu of the timber or wattled structures which originally crowned them. This mound I believe to have been the dwelling of Gwynllyw, the prince of this district, where he founded his church in close proximity to it; and I fully believe that that mysterious portion of S Woolos’s Church, generally called S Mary’s, is the church, or rather the site of the *templum*, first erected by our saint, and enlarged and altered at various subsequent periods, but always spared by adding on the east end, like the church of S. Joseph of Annathea at Glastonbury, when the great abbey was added on to the east end of it.”

In their old age, as already said, Gwynllyw and his wife Gwladys were separated, and she retired to the banks of the Ebbw River, where she continued bathing in a spring of coldest water

The precise spot has probably been fixed by Mr Morgan. He says. "On the banks of the river, above Ebbw Bridge, is a cliff, on the top of which is a small spot of ground, adjoining Tredegar Park walls, of less than half an acre, on which there is a very old cottage. This small detached spot of ground has always belonged to the church of S Woolos, and was part of the glebe land; and when the glebe lands were sold a few years ago, it was purchased by Lord Tredegar. A short distance off, in the park, there issued from the bank a remarkably beautiful spring of very cold water, over which a bath-house was erected in 1719, and it was always called 'The Lady's Well.'" Mr. Morgan conjectures that Lady's Well is a corruption of Gwladys' Well, and that the explanation of this piece of land having belonged from time immemorial to the church of S. Gwynllyw is, that it was the site of the hermitage of the mother of S. Cadog. There was once probably a chapel on the rock, as the place is still called "The Chapel."

Recently, moreover, Lord Tredegar has discovered the tumulus in which she was buried, hard by the chapel and the well.

30 REGULUS or RULE, *B. Senlis, commemorated in Scotland, 4th cent (L).*

31 TURGOT, *B. St. Andrews, Scotland, A.D 1115.*

TURGOT was prior of Durham. On August 1 he was consecrated bishop of St Andrews. He was confessor to S Margaret. York claimed ecclesiastical jurisdiction over Scotland, and this was resisted by King Alexander. The king and Turgot had many discussions. The bishop desired to appeal to Rome, but Alexander allowed him only to go to Durham, where he died in 1115.

APRIL

- 1 GILBERT, *B. Cauthness*, A.D. 1245 (L.)
- 2 EBBA and Comp., *VV. MM. Coldingham*, A.D. 874, see
EBBA, August 25 (L.)
- 3 RICHARD, *B. Chchester*, A.D. 1253 (L.).
- 4 TEYRNOG, *in Denbighshire*, TIGHEARNACH, *B. Clones*,
Ireland, A.D. 550 (L.).
GWIER, *H. at St Neots, Cornwall, before 9th cent*

TEYRNOG or TYRNOG was of the family of Ceredig, and was brother of Tyssul and Caranog. He lived in the sixth century. A suspicion arises whether he be not the same as Tighearnach—one of the many of that name commemorated in Ireland; but the most eminent was the Bishop of Clones, known also as S Ternoc, who was formerly patron of Llanderneau, but which now honours S Tenenan. Tigernach, of Clones and Clogher, was held at the font by S Bridget, and educated at Rosnat; but whether that was Candida Casa, or the Valhs Rosma, now S. Davids, is uncertain. His preceptor there was Monennus. This Tigernach died in 549, and his festival is observed in Ireland on the same day as Teyrnog's in Wales. He is patron of Northull, in Cornwall, where he is called S. Torney Tigernach, or more correctly Tighearnach (anglicised into Tierney), is the Irish form of the Welsh Teyrnog. See also S. Tenenan, July 16

GWIER or GUIER was an anchorite, who lived where now is S Neots, in Cornwall, and when Neot arrived there he took up his residence in a cell that had formerly been occupied by this ascetic.

- 5 DERFEL GADARN, *C. Merionethshire, 6th cent.*
PROBUS and GRACE, *CC Cornwall.*

DERFEL GADARN or "the Mighty" was a member of a saintly family, brother of SS. Suhen, Cristiolus, and Rhystud.

He was famous as a warrior, and was present in the battle of Camlan, in 542, where he greatly distinguished himself, but the latter part of his life was devoted to religion, as a hermit in Meroneth-hire His image of wood, that was greatly venerated, was taken to Smithfield in 1538, and was there burned Derfel's wooden "horse" and "stick" were in existence at Llanderfel not many years ago, and may be still There Bryn Derfel (Derfel's Hill) was much resorted to by the common people at Easter, in order to have a ride on Derfel's horse.

PROBUS and GRACE have a magnificent church dedicated to them in Cornwall, with a tower splendidly wrought in carved granite They were probably Cornish saints, husband and wife, according to tradition

The church was made collegiate by Athelstan in 926 In front of the chancel screen is the legend, "Jesus, hear us, thy people, and send us Grace and Good for ever"—a play on the names of the patrons Two skulls found under the altar, at the restoration of the church, are believed to be those of the two saints, and are placed in a reliquary in the north wall of the chancel The proper name of the parish is Tressilian, or the Habitation of Sulien, but it is commonly called Probus The village feast is on July 5, which is probably the right day; but there is also a fair there on April 5

6 ELSTAN, *B. Wilton*, A.D. 981.

CELSUS, *Abp. Armagh*, A.D. 1128 (L.).

ELSTAN, a monk of Abingdon, trained under S. Ethelwold Whilst building the monastery the workmen had their food supplied by Elstan, who acted as cook, and washed the dishes, swept the floors, and did all the menial work One day S Ethelwold chanced to find him thus engaged in scullery work, and was surprised that he had not committed the dirty task to an underling. The story is told by William of Malmesbury that Ethelwold said, "This obedience of thine has caught me unawares; but, as a good soldier, plunge your hand in the boiling caldron, and pluck me forth a piece of meat" The good disciple obeyed, and drew forth his hand unharmed Everything miraculous in this story depends on whether the caldron was "boiling" or not. It was very easy for tradition to magnify into a marvel a very simple occurrence, and as William of Malmesbury wrote in 1140, there intervened about one hundred and eighty years between the incident and the

record during which the story might grow. Elstan was afterwards abbot of the house, and eventually became fifth Bishop of Wilton. He died 981.

- 7 BRYNACH, *Ab. C. Wales and North Devon*, circa A.D. 450.
 LLYWELYN and GWRNERTH, *CC. Montgomeryshire*, 6th
cent

GURON or GORAN, *C. Bodmin*, middle of 6th cent

BRYNACH WYDDEL, or "the Irishman," was married to Corth or Cymorth, one of the daughters of Brychan, King of Brecknock. He was a priest, and spiritual instructor to the king and his family. He had four children, all numbered among the saints. Not only was he priest, but also abbot.

A Life in Latin, of the twelfth century, is apparently based on Welsh ballads.

For a while he was in Armoica, and when he desired to come to Wales he put a stone on the water, mounted it, and was wafted over to Milford Haven, at the mouth of the Cleddau. There the daughter of the prince became enamoured of him, but as he resisted her advances, she sent men to murder him, and one stabbed him with a lance. Thereupon a swarm of winged ants fell on the man, and so stung him that he suffered great torture and died. The saint then bathed his wound in a spring, ever after called Ffynnon Gôch, or the Red Well.

Finding the place too hot for him he went on to the river Gwain, in Pembrokeshire, that flows into the sea at Fishguard, but did not remain there long. He proceeded to the river Caman, where an angel had informed him a site for a monastery would be pointed out to him by a white wild sow and her piglings. Here he lit a fire, and this was regarded as the assertion of a right to the place. The lord of the district seeing the smoke came hastily to know who had dared to light a fire; but he was a good man, and was at once pacified, and he not only gave land to S Brynach, but also committed his sons to him for instruction. The saint now built a church at the foot of Carn Ingh, above Nevern. Two stags from the forest drew his car, and the cow that gave milk to the monastery was committed to the custody of a wolf. One day Maelgwn Gwynedd came that way, killed and cut up the cow, but no fire would heat the stew made of its flesh. Brynach then restored his cow to life, and gave the king a good repast of loaves he plucked

from an ancient oak-tree that grew near, and the brook for the occasion flowed with wine

Brynach is said to have travelled much, and to have visited Rome. A church in Devon, Braunton, is dedicated to him, and is locally said to have been founded by him on his way home from Italy. Perhaps he put into the bay for water, or repairs to be done to the stone on which he floated. On the roof is a representation of Brynach, or Branock as he is called at Braunton, being the site of his monastery indicated by the sow and her little pigs. Leland, in his *Itinerary*, says, "I forbear to speak of S Branock's cow, his staff, his oak, his well, and his servant Abel, all of which are lively represented in a glass window of that church." This has long perished. Of Abel nothing is known. The mediæval biographer, not relishing the fact that Brynach was a married man and the father of four children, changed his story into one of temptation by a beautiful damsel, daughter of a chieftain, and his strenuous resistance to her seductions.

LIIWELYN and GWRNERTH. Llywelyn was the son of Tregonwy. He founded a religious house at Welshpool, and ended his days at the monastery of Bardsey. Gwrnerth is said to have been his son, but according to another account was his brother, which is more probable. A religious poem by S Tyssilo called "The Colloquy of Llywelyn and Gwrnerth" is found in the Red Book of Hergest. Both saints were commemorated on the same day.

GURON or GORAN was a solitary who resided at Bodmin, surrendered his cell to S Petroc, and probably retired to Gorran, near Mevagissey, where is a church dedicated to him. He died in the middle of the sixth century. When Petroc came to Bodmin, Guron very readily received him, surrendered his cell, and went elsewhere.

8

- 9 MATERIANA, *W. in Merionethshire and Cornwall*, circa
A. D. 500.

DOTTO, *Ab. Orkneys*, A. D. 502.

MATERIANA, to whom two churches in Cornwall look as their founder, *z. e.* Tintagel and Minster, was probably Madrun, a daughter of Vortimer, who married Ynyr Gwent, petty king of

Gwent Below the Wood, or that portion of Monmouthshire that comprised the Caldecott level and the rolling land south of Wentwood. The chief town here was the old Roman city of *Caer Went* (*Venta Silurum*). In this town *Ynyr* received *S. Tathan*, a refugee from *Armorica*, who had been in *Glamorgan-shire*, where he had met with annoyance from *Gwynllyw*, the King of *Wentloog*. To him *Ynyr* gave land, and *Tathan* constructed a monastery. *Ynyr* is numbered among the saints as well as his wife. *Madrun's* sister, *Anna*, was married to *Cynyr* of *Caer Gawch*, the mother of *Non*, who bore *S. David*. *Madrun's* own children were four, three of whom were saints. Probably on the death of her husband *Madrun* retired from the world. She took with her a handmaid, *Anhun*, and along with her founded the church of *Trawsfynydd*, in *Merionethshire*. Whether before or after this she went into *Cornwall* is not known. It is worthy of notice that the church of *Trevalga*, which lies between the two foundations of *Materiana*, is one of *S. Petroc's* churches, and that *Davidstow* is not far off. *Petroc* was probably cousin of *Gwynllyw*, who had retired from the world, and lived near the *Usk*. The whole of this district was thickly colonised from *Gwent* and *Brecknock*.

10

11 GUTHLAC, *H. Croyland*, A. D. 714 (L.).

12

13 BURIANA, *V. Cornwall* (also *May 29*).WINOC or GWYNOCH, *B. Scotland*, circa A. D. 878CARADOG, *P. C. Wales*, A. D. 1124 (L.)

WINOC or GUINOC was a bishop, and is said to have excommunicated the Scots in their war against the Picts, and to have assisted King *Kenneth* by his advice and prayers in a great battle, in which he completely broke the power of the enemy.

He is said to have died about 838.

14 GWODLOEW or WYLLow, *C. Cornwall*, end of 6th cent.

GWODLOEW was the son of *Glywys* the Cornishman, son of *S. Woolo*, of *Newport*, or *Gwynllyw Filwr*. *Glywys* was called a Cornishman because he left *South Wales* and settled in the

western peninsula, where, probably, he married, and where his son remained and founded the church of Lanteglos, by Fowey, where he is venerated under the name of S Wyllow His father is called in Cornwall S. Gluvias.

According to the Welsh pedigrees, there was a son of Gwynllyw, called Gwyddlew, the father of S. Cannen, whereas Gwodloew is the son of Glywys the Cornishman. But of Gwyddlew nothing whatever is known, and we may be pretty sure that there is a mistake, and that Gwodloew and Gwyddlew are one and the same That Gwodloew is the Gudwal who became Bishop of Aleth, now Saint Malo, in or about 627, is possible The old Calendar of S Meven and the Latany of S Vougé call him Gudgual, but this can only be conjecture, as no particulars are given us in the Breton legend as to his parents What is more probable is, that we have in Gwyddlew the original founder of S Olave's, in Exeter, and S Olave's, at Poughill, near Bude Gwynllyw of Newport, now called Woolo, was by the English transformed into S Olavus, and it is likely enough that the same process took place in Exeter and on the confines of Cornwall

There is an inscribed stone at Stowford, near Launceston, with on it GUNGLEI, which in modern Welsh would be Gwynllyw or Gwyngllew This shows that a very similar name was current in the sixth century in the district, which is probably the date of the stone

The church of Lanteglos, by Fowey, was dedicated, according to Leland, to a hermit named Wyllow In Wyllow it is probable that we have again Gwodloew If so, this would be his last foundation. Leland says that Wyllow was murdered by a kinsman named Mellyn The Assize Roll of 12 Edward I (1284) gives this dedication at Lanteglos, so also does a will by Laurence Cok, dated 1502, and another by John Mohun, 1507.

- 15 PADARN, *B Cardiganshire and Radnorshire, and in Brittany*, circa 560 (L.), see also November 1.
RUADAN, *Ab. Lothra, in Ireland, 6th cent.* (L.).
- 16 MAGNUS, *M. Orkney*, A.D. 1110 (L.).
- 17 DOMNAN or DONAN, *H.M. Scotland*, circa A.D. 600 (L.).
STEPHEN HARDING, *Ab. Cîteaux*, A.D. 1134 (L.).

18 OLCAN, *B Ireland (see February 20)*LASERIAN, *B. Leighlin, Ireland, A.D. 639 (L.)*.MAILDULF, *H.C. Malmesbury, circa A.D. 673*

MAILDULF or MAIDULF was an Irish solitary, who about 660 appeared in the forest tract of Braden, off the Roman road from Cirencester to Bath. This woodland was a northern continuation of the great Selwood, and it ran, an unbroken sea of green, as far as the outskirts of Bath. Into this green sea Maudulf plunged, attracted by its solitude and its beauty, and there he constructed a rude hermitage, and opened a school. The Irish monks were at the time great masters of learning—Roman, Greek, and even Hebrew. Maudulf's school became a great centre of learning and of religion. One of his ablest and best pupils was S. Aldhelm, who succeeded him, and who saw Maudulf's burgh grow into an important abbey. The founder died about 673. He is named in a document of Sergius I., in 701 or thereabouts, as the founder of a church in honour of SS Peter and Paul.

19 ALPHEGE, *Abp M Canterbury, A.D. 1012 (L.)*.20 CEADWALLA, *K. West Saxons, A.D. 689.*

CEADWALLA mounted the West Saxon throne in 685, and after crushing the rival under-kings of the house of Cerdic, he prepared to extend his power. He fell on the kingdom of Sussex, and killed the king, Ethelwalch, but was driven back. He returned to the attack later with little better success. He subdued the Isle of Wight with the deliberate intention of putting all the inhabitants to the sword, and this he carried out with ferocious, un pitying savagery, killing men, women, and children, that he might replace the population with his own West Saxons, the first colonists having been Jutes. Having accomplished his bloody purpose, he handed over the spoil as vowed to S. Wilfrid, who does not seem to have lifted a finger to avert the massacre, and whose only eagerness was after the loot.

Ceadwalla threw down his crown in disgust in 688, and withdrew from the land to seek baptism at Rome. There he was received by Pope Sergius I., who baptized him on Holy Saturday, and he died a few days after. The Pope ordered a laudatory epitaph to be inscribed on the tomb of this murderous monster. He died 689.

21 BEUNO, *Ab Wales, 6th to 7th cents.*

MAELRUBH, *M Ireland and Scotland, A.D. 772.*

ANSELM, *Abp. Canterbury, A.D. 1109 (L)*

BEUNO was uncle and spiritual guide to S. Winefred; he was grandson of Gwynllyw Filwr (*see March 29*) He was nearly related to both S. Cadoc and S. Kentigern. He was a native of Powys, and the son of the old age of his parents, who committed him to be educated by S. Tangwn, son of the Welsh bard-saint Talhaian, a contemporary of Taliesin. Ynyr Gwent, who married Madrun, daughter of Vortimer, "gave him a gold ring and a crown," and gave up to him land and the people on it to form a sacred tribe in the West of Herefordshire, at Llanveino, near Clodock. Later on Beuno went to Berriew, in Montgomeryshire, where he was given lands also. But one day whilst there he heard a Saxon shouting to his dogs to pursue a hare on the further side of the Severn, and he at once resolved to leave a place made odious to him, because within sound of the English tongue. In a rage he returned sharply to his disciples, and said, "My sons, put on your clothes and shoes, and let us leave this place, for the nation of this man has a strange language which is abominable, and I heard his voice. They have invaded this land, and will keep it." Then he went deeper into the Welsh land and visited S. Tyssilio, and remained with him forty days. Thence he went to Cynan, son of Brochwel, king in Merioneth, who gave him Gwyddelwern. One day some nephews of Cynan came there and asked for food. Beuno killed an ox, and began to cook it, but the young men became impatient and rude, and this roused the anger of the saint, and he cursed one of the company, so that he died next day. Probably he got on badly with the nephews; anyhow, he left and went to the banks of the Dee, and settled there. The king of the country was one Caradog, who attempted to force Winefred to become his mistress, a beautiful girl, daughter of the man Temic, who had given shelter to Beuno, and when she ran away from him, he cut off her head as she was taking refuge in the church. The head fell within. At that moment Beuno came up and cursed the king, who at once dissolved into a puddle, and nothing solid of him was left. Then he put on the girl's head again, and she was sound, but a spring gushed from the place where her blood had fallen. This is the famous well of S. Winefred in Flintshire.

Then Beuno went to Cadwallon and gave him a gold sceptre

“worth sixty cows,” which Cynan, son of Brochwel, had given him, and this was in Carnarvon

The king gave him a tract of land that really belonged to a widow and her son ; and whilst Beuno was building there the widow came and remonstrated. Beuno was so angry with Cadwallon that he went to him and cursed him. But the matter was compromised, and another piece of land was granted to Beuno

Now it happened that among the workmen employed by Ynyi Gwent was a very good-looking youth, and the king's daughter, Digwg, fell in love with him. The king “chose to give the young man in marriage to his daughter, lest she should have him in some other way.” But the youth did not much relish being saddled with a princess, was oppressed with her highness and mightiness, or ashamed to show her the ancestral quarters, and whilst conducting her to his home took occasion, during her sleep, to cut off her head and leave her. He was incautious enough to commit the crime on the lands of S Beuno, who, discovering the corpse, set on the head again, whereupon the princess sat up, opened her eyes, and asked what had happened. On learning the circumstances she resolved not to pursue the runaway husband, but to remain near S. Beuno. A fountain sprang up here, also, where her blood had fallen. Soon after Digwg's brother, Iddon, came to investigate into the matter, and understanding that the husband had bolted with “the horses, the gold and silver” that belonged to Digwg, and had gone to Aberffraw, he asked Beuno to go with him after the youth. Beuno did so, and when Iddon saw the husband he cut off his head. Beuno immediately replaced his head, also, on the shoulders, and the man lived. Whether he was reconciled to his wife is not related. Beuno now obtained a settlement near Aberffraw, and there died.

This strange legend is at least of this use, that it shows us how the Celtic saints moved about from place to place with extreme restlessness, founding churches in different localities. Beuno lived during parts of the sixth and seventh centuries. He was buried, it is said, at Clynnog, but the honour is also claimed for Bardsey and Nevin. The Jesuit College of S Beuno is at Tremerchion, near S. Asaph. There are two fourteenth-century Lives in Welsh of S. Beuno, and he also figures in the Life of S Winefred. A saying attributed to him is, “From death flight will not avail.”

MAELRUBH was born in 642, and was descended from Niall of the Nine Hostages. In 671, at the age of twenty-nine, he

went to Scotland and founded Apurcrossan, where he presided for fifty-one years. According to Irish accounts he died a natural death, but the Scottish story makes him to have been murdered by Norse pirates in 722. In Scotland he is commemorated on August 27.

22

23 GEORGE of Cappadocia, *M*, circa 285 (L.).DYFNAN, *C. Wales*, circa 460IBAR, *B. Begery, Ireland*, circa A.D. 500 (L.)

DYFNAN was one of the family of Brychan, reputed to have been a son. He founded a church in Anglesea, where he was buried about 460.

24 MELLITUS, *B. London, and Abp. Canterbury*, A.D. 624 (L.).EGBERT, *Mk Iona*, A.D. 729 (L.).*Translation of S. IVO, B. Huntingdon*, A.D. 1001.25 MAUGHOLD or MACCALD, *B. Man, early 6th cent.* (L.).

26

27 ENODER or CYNIDR, *Ab. Brecknockshire and Cornwall, 6th cent.*

CYNIDR was son of Cynon, son of Ceredig of Cardigan, by Rhiengar, daughter of Brychan. Cynidr founded Llangynidr, on the Usk, and Kender Church, in Herefordshire, called Llanccinidr in the *Liber Landavensis*. He had a chapel, according to Dugdale, in an island on the Wye at Winforton, "Capella S. Kenedri." That S. Enoder or Enodoc, in Cornwall, was one of his foundations is probable, as so many of his family settled there. The name S. Enoder is to this day popularly known in north Cornwall as Smknedry, *i.e.* S. Kenedy. S. Cynidr was buried at Glasbury. The Latin clerks, knowing nothing of the native saints, transformed Enoder or Cynidr into

Athenodorus, a pupil of Origen and a martyr under Aurelian In Brittany he is known as S Quidi or Quidic. A chapel is dedicated to him in the parish of S Caradoc, in the diocese of S. Brieuc.

- 28 CRONAN, *Ab. Roscrea, Ireland*, circa A.D. 615 (L)
WINWALOE, *C. (see March 3)*.

WINWALOE. The Life of this saint, by Wrdestan, has been printed in the *Analecta Bollandiana*, T. VII. (1888).

- 29 WILFRID II, *B. York*, A.D. 744.

WILFRID II. was educated at Whitby under S. Hilda, and was one of the five holy prelates whom Bede mentions as having issued from that house. Wilfrid attached himself to the service of S John of Beverley as attendant priest and master of his household. When S John retired from his see he consecrated Wilfrid to be his successor. After some years he retired like his master, and ended his days at Ripon, in or about 744.

- 30 CYNWYL, *C. Carmarthenshire, Cardigan, and Carnarvonshire, 6th cent.*
ERKONWOLD, *B London, Ab. Chertsea*, A.D. 693 (L).

CYNWYL, the son of Dunawd and brother of Dainiol, the first bishop of Bangor. He assisted in the foundation of Bangor Iscoed. After a while he went south and settled in Carmarthenshire. He took up his residence on a promontory of land between two streams, confluent of the Cothi, and seems to have obtained control over a large tract of land, some fourteen to sixteen miles across, and extending from the mountainous core that throws out two arms, between which lies the great basin of the Cothi. Over the whole of this region he must have exercised jurisdiction. Five miles south the rock of Pendinas shoots up in the midst of the basin, and this certainly was at the time the residence of the chief of the district who gave to Cynwyl a place on which to establish his settlement at the head of the basin, on the Annell, that flows into the Cothi, and hard by the gold mines of Ogofau, that had been worked by the Romans.

Here, then, Cynwyl resided. To be away from the throng of men, and to be alone with God, he was wont to retire up the

lovely valley of the Annell, between the heathery and bracken-covered mountain sides, to a point where a great boulder that has fallen from above lies at the junction of a little rill and the Annell, where it comes down foaming from its mountain cradle. Here the old saint was wont to kneel in the bed of the stream and pray, till his knees had worn two holes in the rock. Such is the local legend. More probably he employed the boulder top. But till within the memory of man, the farmers were wont to drive their cattle to this spot and scoop the water out of the hollows over their backs as a preservative against all ills.

There are three saints named Conval in the Scottish calendars; one was a disciple of S Kentigern, and his name occurs as among the bishops next after Kentigern in the Litany of Dunkeld. It has been suspected that Conval and Cynwyl are one; but according to the Scottish authorities, Conval was an Irish prince, who floated over to Scotland on a stone, and landed on the banks of the Clyde. The stone was afterwards called S. Conval's chariot, and men and cattle were brought to touch it to be healed. His body was supposed to lie at Cumnock. Another Conval was trained at Crossraguel. He is commemorated on September 14, and the first on September 28. A third Conval was king, and is invoked as such in the Litany of Dunkeld. He was a ruler in the time of S Columba. There was again another, who was king in 819, and reigned till 824.

Whether the disciple of Kentigern was Cynwyl, who afterwards settled at Caio, or not, cannot be decided. There are several reasons for believing in an association of Kentigern with the Apostle of the Cothi Valley, but the Welsh authorities do not mention any expedition by him to Scotland, although that he went there is by no means unlikely.

Cynwyl also had an establishment at Cynwyl Elfed, in Carmarthenshire, and at Aberporth, in Cardiganshire. Penrhos, in Carnarvonshire, is also dedicated to him. Close to both Cynwyl Gaio and Cynwyl Elfed are dedications to the Pumpsaint, that is, to the Five Brother Saints, sons of Cynyr Farfdrwch, and of the family of Cunedda. Cynyr lived at Caio, and it is quite possible that he may have given the land to his saintly sons, who received and transferred it to Cynwyl, and placed themselves under his direction. They were certainly older than he. The Five Brothers lie at Pumpsaint, in Caio parish, but their church is in ruins. Some association between them and Cynwyl there must have been. There was formerly a church in Brittany in the time of S Convoyon, Abbot of Redon, in the

middle of the ninth century, dedicated to him, as S Cunvolus, so that apparently those of the British who fled to Armonica before the Saxons carried with them the thought of the apostle of the Cothi Valley. For an account of the Five Saintly Brothers see *November 1*.

MAY

- 1 BURIANA, *V Cornwall, also April 13, May 12 and 29, and June 4 and 19*

ASAPH, *B Flintshire, 6th cent. (L.).*

Translation of S BRIOCH, B. Wales and Brittany, 6th or 7th cent. (L.), also August 8.

KELLACH, *B Ireland, 7th cent (L.).*

- 2 GLUVIAS, *C. Cornwall, 6th cent.*

GLUVIAS or GLYWYS the Cornishman, was one of the sons of Gwynllyw the Warrior (see *March 29*), Prince of Gwentloog, who was the founder of S. Woollos, Newport, and of Gwladys of Brecknock, who lies buried under a mound in Lord Tredegar's Park. Why Glywys was called "of Cornwall" does not appear clearly, but he probably fell under the influence of his brother S Cadoc of Llancarvan, who certainly exercised authority and made a foundation in Cornwall, and it is probable that he sent his brother Gluvias to superintend them. After a long time spent in Cornwall he returned to his native land, and founded a church at Coed Cernw, "The Cornishman's Wood." A parish bears his name in Cornwall. His son Gwodloew, under the name of Willow, is founder and patron of Llanteglos, by Fowey (see *April 14*).

- 3 FUMAC, *B. Botriphnie, date not known.*

ETHELWIN, *B. Lindsey, A. D. 720*

ETHELWIN was second bishop of Lindsey after its separation from the diocese of Mercia. A part of his life was spent in Ireland, where he studied, the renown of the learning in the Irish monasteries being great. But he returned to his native

land, and at the request of Ethelred was consecrated bishop by Theodore, Archbishop of Canterbury This was about 680, and he died in 720, having been given Eadgar as coadjutor in 701 on account of his infirmities.

- 4 MELANGELL OF MONACELLA (*see May 27*).

- 5 HYDROC, *C. Cornwall, 5th cent.*

HYDROC. The church of Llanhydrock, in Cornwall, bears this dedication, and the parish revel is held on this day.

- 6 EADBERT, *B Lindisfarne, A.D. 698 (L).*

- 7 LINTARD OR LETARD, *B. at Canterbury, also February 24, which see (L).*

JOHN OF BEVERLEY, *Abp. York, A.D. 721 (L).*

- 8 INDRACT AND COMPANY, *MM ; see February 5 (L)*

INDRACT and COMPANY are said to have been Irish, and to have settled near Glastonbury, where they were murdered Probably Indract was the Abbot of Iona murdered by the English on March 12, 853 It is said that Ina, King of Wessex, brought the relics to Glastonbury, but this is doubtless a mistake, and for Ina we must suppose Edgar to be meant.

- 9 GOFOR, *C. Monmouthshire, uncertain date.*

GOFOR. A saint of unknown date. He is the patron of Llanover, Monmouthshire, in which are, or were, nine springs close to each other, called S. Gofor's Well.

- 10 COMGAL, *Ab. Bangor, in Ireland, A.D. 601 (L)*

- 11 FREMUND, *M. Offchurch, Warwickshire, date unknown*

- 12 BURIANA, *V. Cornwall.* The parish feast is held on this day at S. Burian, as being old S. Burian's Day, that day being May 1 (*see May 29*).

ETHELHARD, *Abp. Canterbury*, A.D. 803.

ETHELHARD was first Bishop of Winchester, and appointed to Canterbury in 780. He corresponded with Alcuin, and died 803.

- 13 MAEL and SULIEN, *CC. Wales, early 6th cent.*
MEREWENNA, *V. Rumsey, circa 970.*

MAEL or MAHAEL was one of the companions of S. Cadfan from Armorica to Britain. He became a member of the College of S. Illtyd, and afterwards removed to Bardsey. Sulien, called also Silin, with his brothers, Rhystud and Cristiolus, accompanied S. Cadfan from Armorica, and also retreated finally to Bardsey. There are dedicated to him the churches of Llan-silin and Wrexham, in Denbighshire, and Silian, in Cardiganshire. (See his Life, *November 8*.) He is coupled with Mael in the dedication of the churches of Colwen, in Merionethshire, and Cwm, in Flintshire.

MEREWENNA, Virgin Abbess of Rumsey, after it had been remodelled by Edgar in 967, was probably of British origin, judging from her name. She must not be confounded with either S. Morwenna of Cornwall, or S. Modwenna of Burton. She died about 970. S. Modwenna died three centuries earlier, and Morwenna five centuries before.

- 14 DYFAN, *M. Glamorganshire, 2nd cent.; also May 24*

DYFAN or DERUVIANUS was one of the company of whom Elfan, Ffagan, and Medwy were others, said to have been sent by Pope Eleutherius to Britain at the request of Lucius. The names come from the Book of Llandaff, a compilation of the twelfth century, and from William of Malmesbury. The whole story is more than doubtful. Dyfan was certainly a Briton, and his pedigree has been preserved. Medwy and Elfan were also British. Churches dedicated to these saints are in the neighbourhood of Llandaff, and there only; consequently, it is probable that there were such people. It is also possible that they may have visited Rome. That is about all that can be said concerning them. We may conclude from the name of the church dedicated to S. Dyfan, Merthyr Dyfan, *i.e.* his *Martyrium*, that he suffered martyrdom.

- 15 BRITWIN, *Ab. Beverley*, A.D. 733 (L).
- 16 CARNECH, *Ab B. Ireland*, circa A.D. 530 (L)
 CARANTOG or CARANOG, *Ab B. Cardiganshire and Cornwall* In Ireland called CAIRNECH, 6th cent (L).
 BRENDAN, *Ab Clonfert*, A.D. 577 (L)
 SIMON STOCK, *C. England and Bordeaux*, A.D. 1265 (L).

CARANOG or CARANTOG, of whom the life is given in the text, is patron of a church in Cornwall. Both Wales and Ireland claim to have given him birth. In Ireland he is called Carnech. When the Exeter Domesday was compiled, the Church of Crantock, in Cornwall, was already in existence.

Among the rocks on the coast of Llangranog, in Cardiganshire, is one formed like a throne, which is called the Eisteddfa (seat) of Carannog. According to the Welsh pedigrees, Caranog was the son of Corun, grandson of Cunedda. He is honoured as well in Brittany, in the diocese of S. Pol de Léon.

- 17 MATHERNUS, *H.C. Cornwall*, circa A.D. 460 (L).
 CATHAN, *C. Carmarthenshire*, circa A.D. 600
 CATHAN, *B. Bute*, circa A.D. 710

MATHERNUS or MADRON is the patron of a church in Cornwall. Mr. Borlase conjectures that Llanpadarn has been corrupted into Madron. This does not seem probable, as there does not seem in Cornish to have been such a permutation of *p* to *m*. He was probably a local saint, or one connected with Brittany, where he is also honoured, and two churches are dedicated to him.

CATHAN was the son of Cawrdaf, son of Caradog Freichfras, thus being of princely family. Cawrdaf was prince of Brecknock. Cathan passed to Scotland, and became a bishop in Bute.

- 18 ELFGIVA, *Q.W. Shaftesbury*, A.D. 971 (L).
- 19 ALCUIN, *P.Mk. at Tours*, A.D. 804 (L)
 DUNSTAN, *Abp. Canterbury*, A.D. 988 (L).

20 COLLEN, *C. Denbighshire, and as COLAN in Cornwall,*
*7th cent*ETHELBERT, *K M. Hereford, A D. 792 (L.).*

COLLEN was a Welsh saint of the seventh century. He is the patron of Llangollen in Denbighshire, and Colan in Cornwall. According to some of the Welsh pedigrees he was the son of Pedrwn, the son of Coleddog (mentioned in the Triads as one of the "Three Ineloquent Men of the Court of Arthur"), but, according to others, the son of Gwynog, of the family of Caradog Freichfras. His Life, written in Welsh, and still untranslated, says that he was the son of Gwynog, and adds that his mother was Ethni Wyddeles (the Irishwoman), the daughter of Matholwch, an Irish prince. His Life states that he went to be educated to Orleans, where he remained for eight years and a half, during the wars of Julian the Apostate, which is an absurdity. Just at that time, in order to bring to a speedy termination the incessant wars between the Pagans and the Christians, a Pagan of the name of Bras challenged, as the champion of Paganism, to fight any Christian that might be pitted against him, laying down that the losing side should henceforth adopt the religion of the conqueror. To this the Pope consented, but when he came to look for his man he could find no one that would consent to enter the combat. However, he was directed at last by a voice from heaven to S. Collen, who was at that time at Porth Hamwnt. The challenge was accepted without the slightest hesitation, and both met, armed for the conflict. Collen, in the first encounter, had the misfortune to have his hand a little bruised, but Bras very kindly gave him a little ointment to put upon it, at the same time endeavouring to persuade him to give in, and believe in his Pagan god. The hand was forthwith healed, but instead of returning the ointment box, Collen threw it into the river, lest either should get further benefit from it. This time Collen felled his antagonist, who implored him not to kill him, and promised to embrace the Christian religion. He was in due time baptized by the Pope, and thereupon "the whole Greek nation believed and was baptized." As a souvenir of this signal victory, the Pope gave Collen a wonderful lily, which he afterwards brought to this country, "and it is said that that lily is still at Worcester."

Collen afterwards came to Glastonbury, where in three months' time he was elected abbot. This post he soon resigned for a mode of life that was "heavier and harder," which consisted

principally of preaching here and there. He again got tired of this, and returned to Glastonbury, where everything went on quite smoothly for five years, when he happened to quarrel with some of the people, and, cursing them, left for "the mountain of Glastonbury" (probably Glastonbury Tor), and made his cell in a quiet spot beneath a rock. As he was in his cell one day, he heard two men talking about Gwyn ab Nudd, and saying that he was the King of Annwn (the Under-World) and the Fairies. Collen put his head out, and told them to hold their peace, as those were merely demons. They told him to hold his peace, and, besides, he would have to meet Gwyn face to face. By-and-by Collen heard a knocking at his door, and in answer got the reply, "It is I, the messenger of Gwyn ab Nudd, King of Annwn, bidding you to come to speak with him on the top of the hill by mid-day." The saint persistently refused to go day after day, until at last he was threatened with the words, "If you don't come, Collen, it will be the worse for you." This disconcerted him, and, taking some holy water with him, he went. On reaching the place, Collen beheld there the most beautiful castle that he had ever seen, with the best-appointed troops; a great number of musicians with all manner of instruments; horses with young men riding them; handsome, sprightly maidens, and everything that became the court of a sumptuous king. When Collen entered, he found the king sitting in a chair of gold. Collen was welcomed by him, and asked to seat himself at the table to eat, adding that beside what he saw thereon, he should have the rarest of all dainties, and plenty of every kind of drink. Collen said, "I will not eat the tree-leaves." "Hast thou ever," asked the king, "seen men better dressed than these in red and blue?" Collen said, "Their dress is good enough, for such kind as it is." "What kind is that?" asked the king. Collen said that the red on the one side meant burning, and the blue on the other, cold. Then he sprinkled holy water over them, and they all vanished, leaving behind them nothing but green tumps.

Collen certainly passed into Brittany, as the church of Langolen, near Quimper, in ancient Cornouaille, venerates him as founder.

In some old Welsh kalendars his festival day is given as the 21st.

21 GODRICK, *H. Finchale*, A.D. 1170 (L.).



GWELY MELANGELL

- 23 WILLIAM, *M. Rochester*, A.D. 1201 (L.)
 WILLIAM. From the Annals of the Church of Rochester it appears that his death took place in 1201
- 24 FFAGAN, *C. Glamorganshire*, 2nd cent., also August 8
- 25 ALDHELM, *B. Sherborne*, A.D. 709 (L.).
- 26 AUGUSTINE, *Abp. Canterbury, Apostle of Kent*, A.D. 604 (L.).
- 27 MELANGELL, *V. Wales, end of 6th cent., also January 31, and May 4.*
 BEDE THE VENERABLE, *Mk. Jarrow, in Northumberland*, A.D. 734 (L.).

MELANGELL or MONACELLA was a daughter of Cywlch, the son of Tudwal, according to some accounts, but of Tudwal according to others, and was descended from the Emperor Maximus and his British wife Elen. Her mother was an Irishwoman. The story goes that her father desired to marry her to a chieftain under him, but either she disliked the man or the thought of marriage, and determined to run away. Accordingly she found an opportunity to escape, and secreted herself at Pennant, one of the most lonely and lovely spots in Montgomeryshire, at the head of the Tanat. Her story is represented on the frieze of the carved oak screen of the church there.

In this spot, sleeping on bare rock, she remained for fifteen years. One day Brochwel Ysgythrog, Prince of Powys, was hunting and in pursuit of a hare, when puss escaped into a thicket, and took refuge under the robe of a virgin of great beauty, whom the huntsman discovered. She faced and drove back the hounds. The huntsman then put his horn to his lips, and there it stuck as if glued. Upon this up came the prince, and he at once granted a parcel of land to the saint, to serve as a sanctuary, and bade her found there a convent. This she did, and she lived in a cell which still remains, though somewhat altered, at the east end of the church. She was buried in the church, after her called Pennant Melangell, and fragments of a

very beautiful shrine remain built into the walls, but sufficient to allow of its reconstruction.

The cell of S Melangell is, as said, to the east of the church, and has no communication with it. It goes by the name of Cell y Bedd, or Cell of the Grave, and it has a door and a window. In this originally stood the shrine. Her *gwely*, or bed, lies on the opposite side of the valley, a quarter of a mile south of the church.

Melangell is considered the patroness of hares, which are termed her lambs. Until last century so strong a superstition prevailed that no person would kill a hare in the parish, and even later, when a hare was pursued by dogs, it was believed that if any one cried "God and Melangell be with thee," it would surely escape. In the Welsh calendars she is also commemorated on January 31 and on May 4.

28 LANFRANC, *Abp Canterbury*, A.D. 1089.

29 BURIANA, *V Cornwall; also April 13, May 1 and 12, June 4 and 19.*

ERBIN, *C. Wales, as ERVAN in Cornwall*, circa A.D. 450.

DAGAN, *B. Ireland and Scotland*, circa A.D. 609.

Translation of S. DYFRIG or DUBRICIUS

BURIANA. This saint is commemorated on many days in Cornwall, but this is the special day of her cult; on the same day in Ireland, Brunech the Slender, daughter of Crimthan. She came to England along with S. Piran (Kieran). In the Life of S. Kieran we are told, "The mother of the saint, who had become a faithful Christian and holy servant of God through the ministry of her son, wished to reside with him, so he built her an abode not far from his cell, and she dwelt there with a community of devout women, whom she had gathered about her: among these was Brunech, a virgin exceedingly fair, and daughter of a chieftain. The holy mother of S. Kieran loved her deeply, because she was her foster-child, and also because she was so lovely in character as in person. But the chief of the country of Hy Fiach, by name Dymna, having heard of her beauty, came with soldiers and carried her off from her cell. Many days he kept her imprisoned in his rath, for he was bewitched by her

beauty. Then Kieran arose and came to Dymna, to demand his sister; but on no account would the chief give her up. 'Never,' said he scornfully, 'will I let her go, unless to-morrow at day-break a cuckoo shall wake me from sleep.' It was mid-winter, and in the night there was a great fall of snow, but not a flake fell where the man of God and his companions tarried. When morning dawned, behold on every turret of the chieftain's castle a cuckoo was perched, uttering plaintive cries. The tyrant arose in alarm, threw himself before the saint, and dismissed the damsel." However, the chief was quailed only for a while, and he recommenced his persecution. According to the legend, Brunech died of fright, but was brought to life again by S. Kieran—that is to say, she fainted, and was revived. When Kieran left Ireland and came to Cornwall he must have taken the virgin with him, or rather, his mother took her, to avoid further persecution.

Nothing has been recorded of S. Buriana's life and labours in Cornwall, except the general tradition that she spent her days in good works and great sanctity; but the place where she dwelt was regarded as holy ground for centuries, and can still be pointed out. It lies about a mile south-east of the parish church which bears her name, beside a rivulet on the farm of Boshiven, and the spot is called the Sentry or Sanctuary. The crumbling ruins of an ancient structure still remain there, and traces of extensive foundations have been found adjoining them. If not the actual ruins, they probably occupy the site of the oratory in which Athelstan, after vanquishing the Cornish king, knelt at the shrine of the saint, and made his memorable vow that, if God would crown his expedition to the Scilly Isles with success, he would on his return build and endow there a church and college in token of his gratitude, and in memory of his victories. It was on that wild headland, about four miles from Land's End, that S. Buriana took up her abode; and a group of saints from Ireland, who were probably her friends and companions, and who seem to have landed on our shores at the same time, occupied contiguous parts of the same district. There she watched and prayed with such devotion, that the fame of her goodness found its way back to her native land; and thenceforward Brunsech the Beautiful, by which designation she had been known there, was enrolled in the catalogue of Irish saints; but her Christian zeal was spent in the Cornish parish that perpetuates her name.—(J. Adams: "Chronicles of Cornish Saints," in the *Journal of the Royal Institution of Cornwall*, 1873)

ERBIN was a son of Constantine the Cornish king, and brother of Digain. Erbin was father of Geraint, Prince of Devon. He was in all probability uncle of the Constantine of Cornwall inveighed against with such gall by Gildas. (See, for fuller notice of him, *January 13*, the day on which he is also commemorated.)

DAGAN was a Celtic saint, educated at Banchor, in Ireland. He mistrusted Augustine, and resented his claims to exercise authority over bishops of an ancient church that had existed for three centuries at least in Britain before he appeared on the scene. He refused to break bread and eat under the same roof with SS. Laurence and Mellitus, so wrathful at their astounding pretensions was this stalwart old saint.

Translation of S DYFRIG or DUBRICIUS. His body was taken in 1120 from Bardsey Island, where it reposed, to be enshrined in Llandaff Cathedral.

30 *TUDGLYD, C. Wales, 6th cent*

WALSTAN, C. Baber, in Norfolk, A.D. 1016.

TUDGLYD was one of the sons of Seithenynd, and when his father's territories were overwhelmed by the sea, he and his brothers, left without earthly inheritance, sought one above that was heavenly and eternal. They became members of the college of Dunawd at Bangor Iscoed, on the Dee. There are no churches founded by him or dedicated to him in Wales. He belongs to the sixth century.

WALSTAN was the son of wealthy parents at Baber, near Norwich. From them he received a pious education. At the age of twelve he renounced his inheritance, and engaged himself on a farm at Cossey, in the neighbourhood, and remained as a poor humble farm-servant till the day of his death, unmarried, and setting such an example of piety, that after his death he was regarded as a saint. That he was the son of rich parents is almost certainly a fable, invented to enhance his merits. He was probably born in the same class of life in which he lived and died. The date of his decease is 1016.

JUNE

- 1 RONAN, *H. Brittany, 6th cent (L)*, see also RUMON,
January 4

TEGLA, *V. Denbighshire and Radnorshire, A.D. 750*

WISTAN, *K.M. Evesham, A.D. 849 (L.)*

TEGLA or THECLA is commemorated on this day in Wales, also on September 23 and October 15. At Llandegla, in Denbighshire, her Holy Well was celebrated for the cure of epilepsy, called S. Tegla's evil. It is questionable whether this saint be the companion of S. Paul, because a dedication of the kind would have been quite contrary to Celtic usage. It is probable that the Welsh Tegla was some local saint. September 23 is the day on which the companion of S. Paul is commemorated, and the Welsh Tegla having June 1 and October 15, looks much as though she were some different personage. She must not be confounded with Thecla, Abbess of Kitzingen (October 15), who almost certainly was a Saxon, and was a disciple of S. Boniface. It is due to a confusion of persons that the Welsh Tegla is commemorated on October 15.

- 2 BODFAN, *C. Carnarvonshire, middle of 7th cent.*

ODO, *Abp. Canterbury, A.D. 959; also July 4, which see (L)*

BODFAN, son of Helg, whose territory was destroyed by the great inundation that formed the Lafan Sands. This low land on the coast of Carnarvon now suffered a like fate to that which had overtaken the cantref of Gwaelod nearly a century before. The Lafan Sands are in Beaumaris Bay. Helg, called Foel, or "the Bald," embraced a religious life together with his son. The date is about the middle of the seventh century.

- 3 COEMGEN or KEVIN, *Ab. Glendalough, A.D. 618 (L.)*.
CWFYFAN, *C. Anglesey, Carnarvonshire, and Denbighshire, 7th cent*

MALCOLM, *K. Scotland, A.D. 1093.*

CWYFAN or CWYFEN, in Irish Ciarbán, was the son of Brwyneu Hên, or "the Aged," of the family of Caradog Freichfras. Sometimes on June 2. For the 2nd we have Welsh Almanacks of last century, and a note by Edward Llwyd, given in "Celtic Remains." For the 3rd some glosses, in an old hand, in a book of "Preces Privatæ," published in 1573, the Calendar in "Allwydd neu Agoriad Paradwys," 1670; "Iolo MSS Cal," and Rees. The 3rd, therefore, is the best supported day.

- 4 NENNOCHA or NINNOC, *V. Abs. Brittany, 8th cent.*
(L.); see also p. 107
BREACHA, *V. Cornwall, 5th or 6th cent.* (L.).
BURIANA, *V. (see May 29).*
PETROC or PEDROG, *Ab Carmarthenshire, Pembroke-
shire, Cornwall, and Devon, 6th cent.* (L.).
CROIDAN, MEDAN, DAGAN, *CC. disciples of S. PETROC,
end of 6th cent.*
- 5 TUDNO, *C. Carnarvonshire, early 6th cent.*
BONIFACE, *Abp. M. Mainz, A.D. 755* (L.).

TUDNO, the son of Seithenyn, and brother of SS. Gwynodl and Mern, was founder of Llandudno, in Carnarvonshire (see Gwynodl, *January 1*) The Whetstone of Tudno was one of the Thirteen Treasures of the Isle of Britain, "which Merlin took with him when he sailed away in the House of Glass, no more to be seen." The whetstone would sharpen the sword of every hero immediately, and always destroy the weapon of a coward. According to another account, it so poisoned the blade of whoever employed it, that whoever was wounded with the sword that had been whetted was sure to die.

- 6 GURWAL, *B. Brittany, 6th cent.* (L.).
GULWAL or GUDWAL, *B. Devon and Ghent, 7th cent.*
(L.).

GURWAL, whose life is given in the text, is thought to have been the same as S. Gudwal, and if so is probably Gwodloew,

son of Glywys of Cornwall, who was one of the sons of Gwynllyw Filwr. But if so, then he cannot be the same as Wyllow, the martyr of Lanteglos (see *April* 14). Gurwal or Gudwal succeeded S. Malo as Bishop of Aleth in 627. In the ancient Kalendar of S. Meen, and in the Litanies of S. Vougay, he is called Guidgual, and his festival is observed in the diocese of S. Malo on June 7. But in most martyrologies he is inserted on the 5th.

- 7 COLMAN, *B. Dromore, in Ireland, 7th cent (L.)*.
 MERIADOC, *B. Vannes, Brittany, 7th cent.*
 ROBERT, *Ab. Newmunster, in Northumberland, A. D.*
 1159 (L.).

MERIADOC was of the royal race of Cynan Meiriadog or Conan of Brittany, and was born about 626, and brought up in the court of Armonca. He devoted himself to the ecclesiastical state, and received orders from the hands of Hincweten, Bishop of Vannes; but instead of labouring for the salvation of the souls of other men, he considered only the perfection of his own, and for this object retired into a solitude near Pontivy, where he made a point of conscience of bending his knee a thousand times a day at the name of God, and as often during the night, which, as a judicious writer, the Père Lobneau, reckons, implies eighty-six or eighty-seven genuflexions per hour, or about one and a half per minute. On the death of S. Hincweten, Meriadoc was elected in his room, and as he refused the dignity, was carried from his cell by force. He seems to have gained great goodwill by his gentleness and pitifulness to all in trouble, and several churches in Brittany are dedicated to him. His popularity extended to Cornwall, and he is the patron saint of Camborne. A curious old Cornish miracle-play exists that contains his legend.

- 8 LEVAN, *C. Cornwall, 6th cent.*
 WILLIAM, *Abp. York, A. D. 1154 (L.)*.

LEVAN or LEVIN is supposed to have been an Irish saint who came to Cornwall. It is possible that his name may be a corruption of Silvanus; in Carew's "Cornwall," Porthlevan is called the Port of Siluan, and it is significant that in the parish of Burian, his fellow Irish saint, there was a chapel dedicated to S. Siluan. If so, it is also possible that

one of the earliest inscribed stones in S Just, not far off, bearing the inscription "Sil . . . hic jacet," may mark his tomb. S Just is not far from S Levan, and a Celtic church was named after the founder, and not the saint buried in it. Of S Levan no records remain, but plenty of local legend, which is not more untrustworthy than the collections of fables concerning Celtic saints made by biographers in the twelfth century in Ireland and Wales. S Levan's cell is still shown at Bodellen, in the parish that bears his name. Between that and the church is a three-cornered garden; this belonged to a woman named Joanna. She was there one Sunday picking pot-herbs, and seeing S Levan go on his way to the sea to fish, she abused him for desecrating the holy day. He retorted that there was no more harm in fishing than in picking vegetables. Angry because she answered him again, he declared that, if any girl were baptized in the water from his well and called Joanna, she would prove a bigger fool than his interlocutor. From that day to this no parents will have a daughter so named at S. Levan, unless baptized at S. Sennen. The path by which the saint walked to the rocks from which he fished is said to be greener than any other turf, even to this day. On the south side of the church is his seat, a rock split in two, and it is said that the split widens annually, and when so wide that a pack-horse with panniers can pass between, then the world will come to an end.

One day, as S Levan was fishing, he caught two breams on his line. Not wanting so much, he threw both back into the sea, but again caught both; he caught them a third time, and then saw that there was some reason for it, so he took them home, and found there his sister Breacha, who had come over with her two children to lunch, and who was hungry herself, and the children simply ravenous. These latter ate so greedily, that both choked with the fish-bones. This produced a lasting coolness between Breacha and her brother.

But there is another conjecture admissible, relative to S. Levan, that he was the disciple of S. Tugdual. Thus Levan drew up a collection of the grants made to his master.

9 MADRYN or MATERIANA (*see April 9*).

COLUMBA, *Ab. Iona*, A.D. 597 (L.).

BAITHEN, *Ab. Iona*, A.D. 601.

BAITHEN or BAITAN was cousin-german and immediate successor to S. Columba in the government of the establishment at

Iona. The story is told that the great saint and founder saw in vision three chairs set in heaven, made respectively for Kieran, Baithen, and himself, the first of gold, the second of silver, and the third of glass, because he himself was "brittle and fragile, in consequence of the battles fought on his account" When eating, Baithen invoked God between every mouthful, and when reaping, he held up one hand in prayer whilst he reaped with the other. He ruled four years, and died in 600.

10 **RHYCHWYN**, *C. Carnarvonshire, middle of 6th cent.*

ITHAMAR, *B. Rochester, A.D. 671 (L.)*

IVO, *B. Huntingdon, 7th cent. (L.)*

MARGARET, *Q. Scotland, A.D. 1093 (L.); also November 16.*

RYCHWYN was one of the twelve sons of Helig the Bald, who devoted themselves to religion when their father's territories were submerged (see Bodfan, *June 2*).

11

12 **TERNAN**, *B. Scotland, A.D. 431.*

Translation of S. ODULPH, P.C. Evesham.

TERNAN or **TORANNAN** was High Bishop of the Picts, and had been baptized by S. Palladius. He is said to have gone to Rome, where the Pope gave him a bell, which however he forgot, and left behind at his lodgings, probably not valuing it. The bell followed him with the instinct of a dog. Being without seed corn, he sent to the Pictish chief and asked to be given some. The Pict forwarded to him a sack full of sea-sand. Ternan, nothing abashed, sowed the sand, and gathered from it a harvest of yellow wheat. This is a rendering into hagiographical language of a very simple fact, that Ternan, having no wheat, employed "maram," a wild corn that grows on sandy districts near the coast, and makes passable cake. It is still employed in Iceland and the Faroe Isles. Ternan died about 431.

13 **SENNAN** or **SEANANUS**, *B. Ireland, A.D. 544; see March 8 (L.)*

SENNAN or **SEANANUS**, of Iniscathy, is commemorated in the Welsh calendars on this day, also on March 1 and 7. In Brittany

on March 6. He is the patron of Plousane. In Cornwall S Sennen, at Land's End, is dedicated to him. There are churches named in his honour at Llansannan, in Denbighshire, and Bedwelly, in Monmouthshire. In Irish martyrologies he appears on March 8, and under this his life is given in the text. He was intimately acquainted with S. David.

- 14 DOCMAEL or DOGMAEL, *H. Pembrokeshire, beginning of 6th cent ; also October 31.*

DOCMAEL or DOGFAEL, son of Ithel ab Ceredig, was a founder of four chapels in Pembrokeshire, and of a chapel, now destroyed, in Anglesey. He belongs to the beginning of the sixth century. He was commemorated also, according to the Welsh calendars, on October 31. He is said to have had a chapel in Liskeard, Cornwall.

- 15 NON, *W. Mother of S. David (see March 3)*
TRILLO, *C. Denbighshire and Merionethshire, early 6th cent*

VEHO or VOUGA, *B. Brittany, 6th cent. (L.).*

ELFLEDA and ETHELHILDA, *VV. Winchester, circa A.D. 950.*

EADBURGA, *V. Winchester, A.D. 961.*

TRILLO, one of the sons of Ithel Hael, who came with S Cadfan from Armorica to Wales, and became a member of the college of Bardsey. He is still remembered in Brittany as S. Drel, but there it is fabled of him that he came with Joseph of Arimathea. The Latin form of his name is Drennæus.

VEHO or VOUGA was an Irishman by birth, born about 518, who came to Brittany rather than occupy the see of Armagh, to which, according to the legend, he was elected, but to which he probably had a hereditary right, after the custom of the Irish Church. The remembrance of him seems not to have remained in his native land. The Irish form of the name is Fiech.

He stepped on to a stone on the coast, and the stone floated away with him, and conveyed him to Brittany, where it grounded at Penmarc. The people on shore, seeing this swimming rock, thought it must be a ship that had lost mast and sail, and came out to pillage it. To their amazement and disappointment they

found nothing on it but one man and any amount of limpets. No sooner had Veho left the rock than it swam away again and returned to Ireland; but a fragment remained, which is now shown in the churchyard of the chapel of S Vouga, at Treguenec. This piece of stone had served Veho as a pillow on his voyage, and in it remains the impress of his head. Veho lived as a hermit near where he had come on shore. However, he was resorted to by so many people that he left, and retired into a forest at Landebecher, near Lesneven, where he died in or about 585. S. Feock, in Cornwall, is dedicated to him.

The very curious litany of S. Vougay is valuable as containing a number of names of Celtic saints. It is reprinted in Graveran and Kerdanet's edition of Albert-le-Grand's "Lives of the Saints of Brittany," Brest, 1837. The church and parish of S Vougay lies half-way between Lesneven and S. Pol de Léon.

EDBURGA or EADBURG was the daughter of King Edward the Elder and Elgiva his third wife. When only three years old, so the tale was told, her father called her to him, and set before her, on one side a number of jewels and female ornaments, and on the other a book of the Gospels and a chalice, and offered her the choice. She at once seized on the latter. This is perhaps not remarkable, as books of the Gospels were in richly-chased metal covers, studded with jewellery, and doubtless much more sparkling and attractive than the ornaments. However, the king, her father, accepted the choice as an indication of her vocation, and he gave her up to be educated for the religious life at Winchester. There she soon won the hearts of the sisters. She rose at night and cleaned the sandals of the nuns whilst they slept. She died about 960.

On the same day are commemorated her half-sisters, Elfleda and Ethelhilda, who were nuns with her at Winchester.

16 ISMAEL, *B. Pembrokeshire and Carmarthenshire, 6th cent.*

CURIG or CYRICUS, *B. Wales, 6th cent.*

ISMAEL was the son of a chieftain in Brittany, who was forced by a dynastic revolution to leave his native land. This chief was Budic. Budic landed in Dyfed or Pembrokeshire, and married Arzanwedd, the sister of S. Teilo, by whom he had two children, Ismael and Tyfei. Both children were devoted to religion by their mother, probably because at the time there seemed to be no prospect for Budic of restoration to his posi-

tion in his own land, and because there was no inheritance for her sons, as she had married out of her tribe. S. Teilo took charge of the children. S. Teilo and Ismael attached themselves to S. David, and were with him when he came to Glyn Rosyn, the valley of the Alun, where now stands the Cathedral of S. David. They arrived at evening, and lighted a fire.

About half a mile down, nearer the coast, is a porphyry rock, starting up somewhat abruptly, which had been enclosed with rude walls, and turned into a caer or fortress by Boia, an Irish Goidel, who held the land around. When he saw the rising column of smoke he was very wroth, and went to the spot to demand by what right squatters had planted themselves on his land without permission. But the grave and saintly appearance of David, and the obvious harmlessness of the three men, allayed Boia's fears, and he returned to his fortress, where at once his wife stormed at him for not killing the intruders. This wretched woman, unable to work her husband into resentment, sent her serving-girls to bathe in the river near where the saints were settled. Then Ismael and Teilo, in disgust, begged their superior to leave the place, saying, "We cannot endure this, nor look on those naughty women." But David bade them be comforted—the annoyance would not last long; their patience and indifference would tire the girls out.

The persistence of Boia's wife at last prevailed, and the Irish chief would have expelled, and perhaps killed, David and his companions, had not another chief named Paucant, son of Liski, come upon him when unawares, penetrated at night by an unguarded entrance into the caer, and murdered Boia and his wife in their sleep. After that he set fire to the wooden buildings in the camp. The remains of Boia's fortress remain, and bear his name, Clegr Fwya, and the port into which Liski and his son ran their keels is still called Porth Lisky.

Tyfei had been murdered whilst a child (see *March 27*). Budic returned to Brittany, and had the good fortune to recover his principality, and to extend his supreme authority over the whole of Cornouaille. Soon after his return there he became the father of S. Oudoc. Ismael remained with S. David, and was consecrated suffragan-bishop of Menevia, we are told, but this must be understood in the Celtic sense, as one of the bishops maintained in the monastery of David. One church in Carmarthenshire and five in Pembrokeshire are dedicated to him.

CURIG or CYRIACUS, termed "the Knight" or "the Blessed" in Welsh literature, is said to have settled in Wales in the sixth century, and to have landed at Aberystwyth. Accord-

ing to one Welsh MS (Iolo MSS 145) he was the son of Unen, son of Cynfach. He is supposed to have been Bishop of Llanbadarn, and Giraldus Cambrensis speaks of his pastoral staff as being preserved in his time in S. Harmon's Church, Radnorshire. When Latin monks invaded Celtic churches, they got rid of the native dedications, or altered them to suit saints in the Roman calendar. This has been largely done with dedications to or foundations of S. Curg. There was a child, Cyriacus, whose head was dashed against a marble stair, when his mother, Julitta, was brought before the Roman magistrate at Tarsus, in Cilicia, and Curg, the Welsh bishop, has been converted into the child martyr. Thus Newton S. Cyres, near Exeter, and S. Juliot's, on the Cornish coast, as well as Llangang, in Wales, are now supposed to honour the child Cyriacus and his mother, in place of the Bishop of Llanbadarn. There are six Welsh hymns in honour of the martyr Curg, wherein he is represented now as an infant, then as an adult, showing the confusion between the bishop and the boy of Tarsus.

Egloskerry, near Launceston, was dedicated to him originally, as the name indicates. In later times, here also the dedication was altered to S. Cyriacus.

Curg is probably the same saint as is known in Brittany as Kérec or Guevroc. In the *Legendaries* of Léon and Foelgoat he is described as having been of obscure or uncertain birth, and the Welsh lists of saints likewise say nothing of his ancestry. He left Wales with S. Tugdual, both having been disciples of S. Illtyd at Llantwit, and settled at the mouth of the Menou, in Domnonia, where his foundation afterwards bore the name of Loc-Kirecq. Thence he migrated to Ploudaniel, in Léon, where he founded a college called Traun Guevroc, in a gloomy valley. Here S. Paul of Léon met him, and saw him in the midst of a blaze of light. S. Paul induced him to leave the place and settle among the ruins of the old Roman city of Occismor, near the now decayed town of Lesneven, and the famous pilgrimage resort of Folgoat.

One Sunday morning he saw a peasant cutting a bunch of rushes, wherewith to stop a gap in his hedge, through which the cattle got in and spoiled his corn. The saint cursed him, and thereupon the rushes remained glued to his arm and breast. It was only after he had acknowledged his fault that the saint released him of the adhesive rushes. The date of his death is about 547.

In Brittany, Kirecq or Guevroc is venerated on February 17, but Curg is commemorated in the Welsh calendars on June 16.

- 17 ALBAN, *M. Verulam*, A.D. 304, *see June 22 (L)*
 MYLLIN, *C Montgomeryshire, uncertain date*
 NECTAN, *B M. Devon and Cornwall, 5th cent.*
 BRIAVEL, *H. Forest of Dean, Gloucestershire.*
 BOTULPH, *Ab*, and ADULPH, *B. Lincolnshire, A.D. 655*
 (L)
 MOLLING, *B. Ferns, in Wales known as MYLLIN, A.D.*
 697 (L.).

NECTAN is said to have been a brother of S Morwenna, and one of the family of Brychan of Brecknock. He settled on the headland of Devon that forms one of the horns enclosing the Bristol Channel, but his name is also associated with a stream and waterfall near Tintagel, in Cornwall, and a chapel in the parish of S. Winnow. There is a local tradition that when S. Morwenna was dying, her brother ministered to her, and raised her head that she might with her dying eyes look on Wales, whence she had come. Nectan died a martyr at Hartland, and was there buried. His name does not occur among the sons of Brychan in the Welsh lists, and in this, as in other cases, "son" means no more than a member of the Brecknock princely tribe—a nephew, a grandson, or one even more remotely related.

18

- 19 BURIANA, *V. Cornwall (see May 1).*
- 20 *Translation of S. EDWARD, K.M Shaftesbury, A.D.*
 982 (L.).
- 21 CORMAC, *Ab. Durrow, Ireland, end of 6th cent.*
 MAEN or MEVEN, *Ab. Brittany, called in Cornwall*
 MEWAN, *7th cent. (L.).*

MEVEN is the Mewan of S. Mewan near S. Austell, in Cornwall, and also the S. Mewan of Mevagussy.

In the life of S. Meven, Maen or Conard Maen, he is said to

have been a son of one Erc, and to have been a native of Gwent, and akin to Samson of Dol, on his mother's side.

Samson was consecrated by S Dubricius about 550. He resolved on leaving Wales for Armorica, and was in Cornwall at some time after his consecration, and there he met S Petroc, as is related in the life of the latter saint. As he attended the Council of Paris in 557, it was probably between 550 and 557. The Life of S Maen says that he accompanied his uncle to Brittany.

It was on their way to Brittany that Samson with his disciples and retinue halted in Cornwall. They tarried first at Southill, near Callington, then went on to the mouth of the Fowey, where they remained till news reached them that they might safely adventure themselves in Brittany. At this time S. Samson founded the church of Golant, and Mewan those of S. Mewan and Mevagissy.

On reaching Brittany he remained some while at Dol, and was much employed by Samson. The latter went to Paris to see whether he could not obtain Judual, the rightful prince of Domnonia, and set him up against Connor, the usurper. Whilst Samson was in Paris, Mewan travelled to and fro, working up the minds of the dissatisfied against Connor. On one of these expeditions he was traversing the vast central forest of Brechian, when he came on a clearing about a *tref* occupied by a refugee Briton named Caduo. He had lived there in peace with his family; but his children had all died, and he felt his loneliness. He received Mewan as a fellow-countryman with warmth; "Come in," said he, "I have plenty of hay and straw on which to litter you." He fed them well, and Mewan and his followers made the night musical with psalms. Before they left, Caduo said to his guest, "I am solitary, come and live here with me as long as I am above ground, and then take it all for yourselves."

After a little meditation Mewan agreed to this. And thus was the first instance of one of the ecclesiastical colonists founding a monastery in the forest. All previous monastic settlements had been by the seaside. It was more than this, it was the first real attack made on the mighty forest which held the centre of the land. During his life, Caduo placed Mewan at Trefoss, a farm beyond the river, true to the principle that the *lann* and the *plou* should be separated, and not too near each other, as distinct organisations under distinct heads.

It was to the monastery of S. Mewan that Judicael fled from his brother Hoeloc or Alan I., and there the prince acquired

such a love for monastic life, that after he left it to mount the throne and take to himself a wife, he sighed for the peace of the forest retreat, and finally resigned a crown he had not much capacity to bear, and reverted to the life of a monk. Mewan is thought to have died about 640. The touching story of his disciple Austell is told under the name of the latter. The date given is that considered probable by M. de la Bordene. Lobineau gives it as 617, but that is perhaps too early. Judicael's retreat was in 605 to 610, and Mewan was then his abbot. But it is quite uncertain how long Judicael remained on the throne after his accession. Probably his incapacity declared itself pretty speedily, and he retired after a short reign to place himself once more in the hands of Mewan. I should be disposed to think this was in 627, and that this would be also about the date of the death of the saintly abbot.

22 ALBAN, *M. Verulam*, A.D. 304 (L.).

WINEFRED, *V.M. Flintshire*, see November 3 (L.).

23 ETHELDREDA, *V. Abbs. Ely*, A.D. 679; also October 17.

24 VEOP, *V. Cornwall* (see July 1).

GERMOC, *K.C. Cornwall*

BARTHOLOMEW, *P.H. Farne*, A.D. 1182 (L.).

GERMOC or GERMOE was a member of a tribe in Ireland, related to the chief, but perhaps on account of a quarrel or out of restlessness, he and his sister Breaca came to Cornwall and settled on the south of the Tregonning and Godolphin range, near Mount's Bay. A local Cornish saying is that Germoc was a king, and Breaca a midwife. This means that he was of princely race, and that she was invoked by women in labour. In the churchyard outside S. Germoc's Church is a granite seat called S. Germoc's chair.

25 MOLOC or MO-LUOCH, *B. in Scotland*, circa A.D. 592.

SOLOMON, *K.M. Cornwall and Brittany*, circa A.D. 547.

MOLOC or MO-LUOCH is not to be confounded with the illustrious Molua, of Clonfert. His original name was Lugardh or Lua, with the honorific prefix *mo*, and the endearing suffix of

oc. He is mentioned by S. Bernard in his *Life of S. Malachy*, where, in describing the reconstruction of the abbey of Bangor, in Ireland, he goes back on its past history, and relates how that Congal had been the spiritual father of many thousands of monks. "Verily, the place was holy, and fruitful in saints, plentifully rendering a harvest to God, so that one of the sons of that sacred congregation, Luan by name, is said himself alone to have been the founder of a hundred monasteries. . . . Finally their shoots so filled both Ireland and Scotland, that the words of David seem to be a prophecy of these very times "Thou visitest the earth, and blessest it; thou makest it very plentifulous." In the Irish martyrologies, Moluach is remembered. Ængus calls him "the pure and brilliant, the son of Lismore, in Alba." The Aberdeen Breviary has some wonderful stories concerning him. He was educated by S. Brendan, and he went about founding churches. One day, requiring a square iron bell, he asked a blacksmith to hammer him out one, but the man replied that he had no charcoal. Thereupon S. Moloch brought rushes, and the fire was kept up with them till the bell was made, and this bell was long preserved in Lismore. He was at the time in the north of Ireland, and he wanted to take ship for Alba, but as he was unable to procure one, he stood on a stone and drifted on the waves, using the stone as a vessel, till he came to the mouth of the Firth of Lorne, and sailed up it, past Mull, and landed on the island of Lismore, and thus his bell was lost to Ireland for ever. Not finding the islanders amenable to his teaching, he went to Melrose, but the abbot sent him back to Lismore, and now success attended his ministrations. He went much about, and founded churches in many places. He was buried in the church of Rosmarley. His staff is still in existence, and is in the possession of the Duke of Argyle. He died in 592 or thereabouts.

SOLOMON or SELYF was the son of Gerant ap Erbin (S. Ervan), and brother of S. Cyngar, Caw and S. Iestyn. He was duke or princeling in Cornwall, and married S. Gwen, sister of S. Non, and by her was father of S. Cybi. It may be suspected that both Launcells (Llan Selyf) and Lansallos were of his foundation; though in later days, when the Latin Church obtained the mastery, Launcells was dedicated to S. Andrew. Lansallos was thought to be dedicated to a female saint, Ildierna or Salwys. The latter is a corruption of Selyf. Of Ildierna nothing is known. Tiern is kung, and the name is made up of Selyf-tiern, that is to say, Selyf the King. In Brittany he is revered as a martyr, and his date is advanced a century. But as he is there

represented as father of S Cybi, there can be no doubt as to his identity with Sil-Tiern, or Solomon, king in Cornwall. The Bretons represent him as the son of Congar, whereas he was actually the brother of that saint and martyr. They also make him the father, instead of uncle, of S Constantine, as likewise of S Eldad, whom they confuse with S Illtyd, whereas Eldad was son of a different Gerant, not the Prince of Devon. According to the legend, Solomon or Selyf became a king in Léon, and it is probable enough that in some of the disturbances and rivalries that distracted the principality he may have left Cornwall and established himself in Léon. The princes and saints of Cornwall and of Brittany are so inextricably mixed up together, as to lead us to suspect that in the sixth century the Domnonian and Cornish kings held sway in the portions of Armorica they had colonised, and that the Breton Cornouailles and Domnonia were portions of this realm, just as the Duchies of Normandy and Anjou were afterwards appanages of the English crown, though in inverse manner, as England was conquered by the Normans, whereas Armorica was occupied and annexed by the British.

If this be the explanation, then it is not surprising to find Selyf in the Continent as well as in Cornwall.

In Armorica we are told the natives by no means relished the forcible occupation of their land by colonies from Britain, and were in constant revolt. Unquestionably the inhabitants of Armorica were pagans, and had not received the Gospel before the arrival of the fugitives from Britain. The legend represents King Solomon as imposing Christianity on the natives, and as their resenting it and rising in revolt against him. A fight ensued, and he was killed. But all this is very uncertain.

Great confusion has reigned among Breton hagiographers relative to Solomon. There were three of the name—Solomon I., of whom an account has just been given, who died about 550; Solomon II., who died about 632; and Solomon III., who was killed in 857. The first and last are both reckoned as saints and martyrs. Solomon III. was a great scoundrel, who obtained his throne by murder. Nevertheless, as he died a violent death, he is considered to have been a martyr. The Bretons throw back Solomon I. to a much earlier period, so as to make him grandson of Cynan Meiriadog, and give him as wife a daughter of Flavius Patricius, daughter of Avitus, but the only authority is a fabulous life in the Breviary of Vannes. In Brittany he is called Salaun, and the scene of his death Merzer (*i.e.* Merthyr, in Welsh) Salaun.

- 26 TWROG, *disciple of S BEUNO, C. Carmarthenshire and Merionethshire, 6th cent*

Translation of S. BRYNACH, C. in Wales

TWROG, son of Ithel Hael, attended S Cadfan from Armorica to Wales; he was a disciple and amanuensis of S. Beuno. Twrog's book, called Tiboeth, which he wrote for his master, and which was kept in Clynog church, is now supposed to be lost.

27

- 28 AUSTELL OR AUSTLE, *H.C. in Brittany and Cornwall, 7th cent.*

AUSTELL was a disciple and friend of S. Mewan or Mevan, who is commemorated on June 21. There is, unfortunately, no record as to whence he came or who was his father; but as Samson and Mewan left Gwent on account of the Saxon invasion shortly after 550, it is probable that Austell was one of the company. S. Samson, we are told, took with him a large band of disciples, and tradition accuses him of carrying off with him into Brittany all the manuscripts he could collect. "Scarce am I reconciled to this Samson," says old Fuller, "for carrying away with him the monuments of British antiquity. Had he put them out to the Bank, by procuring several copies to be transcribed, learning thereby had been a gainer, and a saver had he only secured the originals; whereas now her loss is irrecoverable, principal and interest. Authentics and transcripts are all embezzled; nor is the matter much whether they had miscarried at home by foes' violence, or abroad by such friends' negligence." But it must be remembered that everything that was left would have been destroyed by the Saxons. On reaching the coast, Samson dismissed his ship, and procured a waggon to convey his load of holy vessels and choice manuscripts across the country. This was in Cornwall. From hence they crossed to Brittany.

According to Welsh tradition, Samson returned in his old age to Wales, and his cross is still shown at Llantwit Major. On which occasion Maen and his companion and friend, Austell, were in Cornwall, must be left in uncertainty. All we know of Austell we derive from the life of S. Maen, and that is little.

He was a priest and a solitary, and he was under the direction of S Mewan, and loved him as his own soul

A pretty story is told of the death of the old abbot. As he lay a-dying, he saw his friend at his bedside, with his face bathed in tears. The dying man put out his hand and wiped away the tears from Austell's eyes, and said, "Weep not. I, your father, go before. In seven days prepare to follow me."

S Maen or Mewan died on June 21, and on June 28 he was followed by S Austell. The brethren resolved on laying him beside his spiritual guide and friend, and opened the sepulchre of Maen, when they saw that the body they had laid in it on the back was moved away to the right side, to make place for the loved disciple.

It is very probable that S Austell, in Cornwall, is a foundation of this companion of S. Maen. Two churches, that of S Mewan and that of Megavissy, that adjoin S Austell, have this Mewan or Maen as their founder. On the tower of the church is represented Christ between a pilgrim or hermit with a rosary, on the right, and an archbishop on the left, with crozier. Leland says that Austulus, to whom the church was dedicated, was a cenobite. Doubtless, the figure on the left hand of Christ is S. Samson of Dol, who, in the middle ages, was represented as an archbishop, and it was fabled that he had been Archbishop of York, and had received the pall from the Pope.

29

30 *EURGAIN, V. Flintshire, 6th cent.*

EURGAIN was the daughter of the tyrant Maelgwn Gwynedd, King of the Britons, who died of the yellow plague in 560. She was married to Ehdyr Mynfawr. There was another saint of the same name, daughter of Caradog, a princeling of Glamorgan. She founded Cor Eurgain, which afterwards became S. Illtyd's College of Llantwit.

JULY

- I JULIUS and AARON, *MM. Caerleon, Monmouthshire*,
A.D. 304 (L.)
- SERVAN or SERF, *B. Orkney and Fife*, circa A.D.
460 (L.)
- CEWYDD, *the Welsh Rain-Saint, C. Radnorshire and
Glamorgan, 6th cent.*
- VEEP or WENNAPA, *V. Cornwall, early 6th cent.*
- LEONORE, *B. Léon, circa A.D. 560 (L)*

JULIUS and AARON. Although there is no early record of their martyrdom, it is difficult not to acknowledge the tradition of their having suffered at Caerleon, the Roman Isca Silurum, as well founded. The names so singularly united, one Latin, the other Hebrew, seem unlikely of being invented in this combination. The martyrs were probably soldiers of the second Augustan legion, which was quartered at Caerleon, although Gildas says they were citizens. The churches or *martyria* over the spots where they suffered were of early foundation. That of S. Aaron was at the camp of Penrhos, half a mile north of Caerleon. The site of S. Julius' chapel is near a point of land about which winds the Usk, about half a mile down the river, where some remains of the building still exist, built into a modern residence. The name Julius is locally changed into Julian.

CEWYDD, the Welsh S. Swithun, was a son of Caw of Prydyn (North Britain), who was lord of Cwm Cawlwyd in the north, but being compelled to leave his territory, settled in Anglesey. He is the saint who among the Welsh was credited with determining the weather for them for forty days, like S. Swithun, according as it rained or otherwise on his festival. A curious story is told in the Life of S. Cadoc relative to his father, Caw:—"On a certain day Cadoc was digging the ground about his monastery"—which he was founding in Scotland—"when he found a collar-bone of some ancient hero of incredible size." Then he vowed he would not eat nor drink till he had learned to whom it had belonged. That night an angel appeared to him and bade him resuscitate the giant whose collar-bone he had

got hold of. This he did next day. He dug up a great skeleton, and further, he infused into it new life. The resuscitated giant knelt at the feet of Cadoc and announced that he was Caw of Prydyn, who had been killed in battle. Cadoc then set him to dig the ground for his garden. "Therefore, from that day to the death of the man of God, the digger performed by digging what had been commanded him."

VEEP, WYMP, WENNAPA, are probably the same person; Veep being, indeed, a modern corruption of Wymp or Wennapa. This saint is the Welsh Gwenafwy, daughter of Caw, and sister of SS Samson of York, Eigrion, and Peirio. Eigrion came into Cornwall, and Gwenafwy must have come with him. No foundations by her brother can now be recognised, but there are two of hers, one of which preserves her name in its Latin form or approaching it, Gwennap, and the other in its popular contraction as Veep. In the fourteenth century Bishop Grandison reconsecrated the church of S Veep and dedicated it anew, this time to SS Cyniacus and Julitta. Probably the legend of S Wennapa had been lost, and it was inconvenient for a church to be deficient in proper lessons for the festival of the founder. But another object was to get rid as far as might be of the local saints and bring all to the dull uniformity of the Latin Kalendar. But the people would not forget their ancient patron, and the village feast of July 1 remains as her commemoration. In the parish was in 1236 a cell of S Carroccus, that is to say of S. Caradoc, father of S Malo; and a Llan of S Gwynog, her nephew, son of Gildas, a disciple of S Cadoc, adjoins her settlement. Caw, the father of S Veep, had been a chief in North Britain at the end of the fifth century, but the invasion of the Picts and their repeated ravages drove him south. He settled in Anglesey, where lands were given him by Maelgwn Gwynedd; but his children went into South Wales, where King Arthur granted them lands; some, however, clearly were obliged to go elsewhere, into Cornwall and Brittany. Caw's family is reckoned as the third holy family of Britain. Aneurin the poet was one of his grandsons, otherwise known as that acrimonious Gildas who thought it seemly to pour out his ill-temper in abuse of his native race. Another son, and brother of Veep, was Ædan, disciple of S David, and Bishop of Ferns, in Ireland.

LEONORE. In the text a summary has been given of the fables related of him. It is possible to come to a tolerably clear understanding relative to him by comparison of the lives of the saints of his family. Lobineau considered him to be the son of Hoel the Great and of Alma Pompæa, but his father is

also called Eloc, which is merely a form of Hæloc, *æ* being a common Celtic diminutive His brother was S Tugdual or Tudwal In one of the dynastic revolutions that occurred so frequently in Armorica as in Wales, his father had to fly to Britain, and he committed Tugdual and Leonore to the care of S Iltyd. Leonore was ordained by S. Dubricius at Caerleon Then, about 535 he went to Brittany at the head of a large colony of monks and lay-folk, and disembarked on the shore at Crévelin, on a spot of land just west of S. Malo The land was dense with forest a little way back from where the blast from the sea twisted and withered the trees, and Leonore set his disciples to work to make a clearing. The lay colonists who had placed themselves under his leadership did not like the situation, and deserted to found settlements elsewhere The monks worked hard at cutting down the timber. They used fire to clear the wood, but were unable to consume it, because green. The ground was encumbered with trunks. The legend is to the effect that these were miraculously transported to the sea by a flood. Probably the monks managed to roll the logs down into the water at low tide, and they were carried away when the tide rose The legend is picturesque. It represents the whole forest as floating away like islets of verdure. The ground cleared, the next thing to be done was to till it, and here we have introduced the oft-repeated tale of stags harnessed and drawing the plough.

Whilst engaged in this work, one day the share turned up a statue of a ram of pure gold, which he put aside, saying, "Gold is for kings and not for priests."

It was to the settlement of S. Leonore that Judual fled from Connor, who sought to murder him Connor learned where he was, and went to the monastery in quest of him. Leonore put the prince in a boat, and when Connor demanded that he should be surrendered, pointed to the vessel ready to sail. Connor, furious at losing his victim, boxed Leonore on the ear, then mounted his horse to ride away. As he was shortly after thrown and broke his thigh, he supposed that he was thus punished for having struck the saint. However, he continued to annoy him, and Leonore entered into the conspiracy started by Samson of Dol to obtain the restoration of Judual and the expulsion of Connor Judual was at the court of Childebert Leonore now took the gold ram which he had found, and went with it to Paris, where he was well received, and the king was delighted with the statue, and in return promised his protection against Connor, and gave Leonore rights of sanctuary as far as

the sound of his bell reached; but he could effect nothing with Childebert towards the restoration of Judual

The legend of his life describes the mode of existence in the monastery — "At cockcrow the monks celebrated matins (*nocturnas vigiliis*) and lauds (*matutinas laudes*). As soon as dawn broke they returned to their duties of hard labour. While thus engaged they said the canonical hours, that is to say, prime, second, terce, and sext. A little before nones (3 P.M.) they left work and went to the church, praising the Father, Son, and Holy Ghost by saying *Benedicite omnia opera*, to the end of the psalm. Then they said the office, and after that took their refection. But before going to table, they tithed their repast and cast the tenth to the birds and beasts, for there were no poor in those parts, they had all in common."

Leonie in Brittany is Lunaire. His tomb is shown in the parish church that occupies the site of his foundation. His festival was kept in the diocese of Léon on July 1, at Dol on February 16, at S. Malo on July 16, and at Coutance on July 3.

- 2 OUDOC, *B. Llandaff*, A.D. 564 (L).
SWITHUN, *B. Winchester*, A.D. 862 (L).
- 3 PEBLIG or PUBLICIUS, *C. Carnarvon*, 5th cent.
GERMANUS, *B. Man*, 5th cent. (L).

PEBLIG (PUBLICIUS) was either son or grandson of Maxen Wledig (MAXIMUS) and Elen, and lived in the fifth century. He settled in Carnarvon.

- 4 *Translation of S MARTIN, of Tours.*
- 5 MODWENNA, *V. Abs. Burton-on-Trent* (see July 6).
MONGUNNA, *V. Abs. Ireland*, circa A.D. 650.
ODO, *Abp. Canterbury*, A.D. 958 (L).
EURFYL, *V. Montgomeryshire, uncertain date.*
PROBUS and GRACE, *CC. Cornwall* (see April 5).

EURFYL or ERFYL, who founded the church of Llanerfyl, in Montgomeryshire, is of uncertain date, and next to nothing is known of her. The old inscribed tombstone in the churchyard of Llanerfyl is not hers, as has been generally supposed.

- 6 MORWENNA, *V. Cornwall, 5th cent.* (L.)
 PALLADIUS, *B. Ireland, circa A.D. 430* (L.).
 MONYNNNA, *V. Ireland and Scotland, circa A.D. 518*
 (L.).
 MODWENNA, *V. Abss. Burton-on-Trent, 7th cent* (L.).
 SEXBURGA, *W. Abss. Ely, A.D. 699* (L.).
- 7 ILTUT or ILLTYD, *Ab. Wales, 6th cent.*
 MEDRAN and ODRAN, *CC. Ireland, 6th cent.* (L.).
 MERRYNN, *C. Cornwall (see January 6)*.
 ETHELBURGA, *V. Abss. Faremouthers, A.D. 695* (L.).
 HEDDA, *B. Winchester, A.D. 705* (L.).
 WILLIBALD, *B. Eichstadt, A.D. 786* (L.).
Translation of S. THOMAS A BECKET, A.D. 1220

ILTUT or ILLTYD was a native of Brittany or Armorica, where his festival is observed on November 7, and was the great-nephew of S. Germanus, of Auxerre. The Welsh authorities call him "the Knight," and it is probable that he was engaged in a military career for some time. He served in the court of Saul, King of Morganwg. One day the king was out hunting, when, feeling hungry, and being near Llanancarvan, he ordered his men to go to S. Cadoc's abbey and take what was required for their meal. Thus they did, Illtyd alone refusing compliance. He "stood afar with a hawk, which he sometimes loosed and directed after birds"

Then a miracle occurred: the earth swallowed up the men and the stolen meal. Thus so affected Illtyd as to work his conversion. All the land about Llanancarvan was at this time a great unreclaimed swamp, and the truth of the story probably is, that in hunting that day several of the king's men were smothered in a bog, and that Illtyd was for a while in extreme danger himself, and when almost despairing of escape from the morass, vowed his life to religion.

He left the king, and, with his wife and attendants, retired to the banks of the Dawnon, and built himself a cabin, and others for his servants, of bushes and reeds. The huts they thatched, "that it might not ram on their beds." Then he dreamt that the place was unsuitable.

Next morning, early, he bade his wife get out of bed and collect the horses. She at once obeyed, and went out to catch the steeds without a stitch of clothes upon her, covered only by her flowing hair. On her return, leading the horses, and that in a high wind that was keen with frost, Illut, instead of being ashamed of having lain comfortably in bed whilst sending his wife out naked to run after the horses, "greatly regretted that he had loved such a person; and he vowed to desert her," which the monkish biographer considers the height of virtue.

The story goes on to say that the poor woman, shivering with cold, having brought the horses, wanted to go back to bed and get warm, but Illut threw her garments at her head, and bade her pack, and kept her out of bed. "She put on her clothes and sat down, and begged with a trembling heart to be allowed to get into bed again at his side." But Illut absolutely refused to share the blanket with her, and drove her away.

The real truth of the story is, that the first community founded by Illut was one in which the married people lived together, as was usual in Celtic religious communities of the first period, and probably the transition to the second stage is marked by the settlement at Llantwit Major. At Llantwit, Illut made a square enclosure, enclosed within a mound and palisades, and within were bee-hive huts occupied by the monks, and seven small stone churches.

One day the chief of the country was hunting a stag, and the poor beast, much harassed, fled to the religious settlement, entered the hut of Illut, and lay down at his feet. The chief followed and demanded the stag, thus the saint refused to give up.

It is a pity that the saint did not exhibit as much humanity to his wife as he displayed to the stag.

She remained where he had left her for some time; but at last, moved by affection, she went to Llantwit, where she found him clothed in skins, his face soiled, his hands hard with work. He drove her away, and for having dared to come after him she was afflicted with blindness. However, she sought him once again, and then he interceded for her; she was cured of her blindness, but forbidden ever to come near him again.

Illut had much difficulty with the chief of the tribe of the land, who demanded tribute of the ecclesiastical tribe, and doubtless also called forth the retainers for war. The superintendent of the prince, for making this demand, was cursed by the saint, and thereupon he melted down into a lump of bee's-

wax. Nevertheless, the prince insisted on his rights, and at last Iltut left Llantwit and took refuge in a cave. One day a messenger of Gildas was passing the cave, carrying a bell as a present to S David, when suddenly the bell began to ring violently of its own accord. Hearing the bell, Iltut looked out of his cave and asked to be allowed to ring the bell. This was granted, and he then returned it. But when the bell reached its destination it was mute, and remained so till surrendered to Iltut. Then Iltut returned to Llantwit, but it was to fresh quarrel with the chief of the land. He paid a visit to Brittany, and in a time of famine was able to send corn from Wales for the relief of the famishing people. He died in Armorica, at Dol. None of the Welsh calendars give the 7th July as his feast; only Wilson in his second edition of the "Martyrologe" (1640), and Father Stanton, "An English Menology" (1887).

- 8 KILIAN, *B.M. Wurzburg*, A D. 689 (L.)
 WITHBURGA, *V. Dereham, in Norfolk*, A D. 743.
 GRIMBALD, *Ab. Winchester*, A.D. 903 (L.)
 EDGAR, *K. English*, A D. 975 (L.)

WITHBURGA was the youngest daughter of Anna, King of the East Angles. As a child she was brought up at Holkham, where subsequently a church was dedicated in her honour, but when her father fell in battle she took refuge at Dereham. For some time she was sustained by the milk of a hind. She died about 743.

- 9 EVERILDIS, *V. England, 7th cent.* (L.)

10

- 11 DROSTAN, *C. Scotland, circa A.D. 600* (L.)
 CYWAIR or COWAIR, *V Merionethshire, uncertain date.*

CYWAIR or COWAIR is a virgin saint of whom nothing is known. The little church of Llangower, in Merionethshire, is dedicated to her.

12

- 13 MINVER, *V. Cornwall (see November 24).*
 DOGFAN or DOEWAN, *M. Pembrokeshire and Denbigh-
 shire, 5th cent*
Translation of S. JUTWARA, V.M at Sherborne, circa
A.D 700.
 MILDRED, *V. Abss. Thanet, 8th cent. (L.).*

DOGFAN, DOGWAN, or DOEWAN, was one of the many sons of Brychan Brycheiniog. He was slain by the pagan Saxons at Merthyr Dogfan, meaning his *martyrium*, in Pembrokeshire, where a church in his memory was erected. It is not easy to understand how the Saxons could have got into Pembrokeshire at this time. It is more probable that he fell a victim to some of the corsairs who were continually harassing the coast.

The cloudberries growing on the Berwyn mountain are popularly called Mwyar Doewan, his berries.

JUTWARA or JUTWELL was the sister of S. Sidwell, consequently also of S. Paulus Aurelianus. Her sister Wulvella was settled at Laneast, in Cornwall. The adjoining parish is Lanteglos, dedicated to S. Julitta, and in it is the holy well called Jutwells. The rededication to Julitta probably took place when reconsecrated by one of the bishops of Exeter. It is not possible to say by whom Lanteglos was originally founded, and who was its first patron, but it is within the range of probability that it was Jutwara or Jutwell, the sister of the two commemorated at Laneast. Jutwara was killed by her brother, to whom she had been falsely accused of incontinence. He cut off her head. Where it fell a well bubbled up. She rose, took up her head and carried it to the church. Her body was translated to Sherborne Abbey.

- 14
- 15 ADEODATUS or DEUDEDIT, *Abp. Canterbury, A.D. 664*
(L.).
 DONALD, *C Scotland, circa 716 (L.).*
 EDITH OF POLESWORTH, *Abss Warwickshire; see*
September 16 (L.).
Translation of S. SWITHUN, at Winchester, A.D. 970,
see July 2 (L.).

- 16 HELIER,
- H.M. Jersey, 6th cent (L.)*
- .

TENENAN, *B. Brittany, 6th cent.*

TENENAN, son of Tinidor, an Irish prince, probably Tighernach, is venerated in Brittany, at Lauterneau. There exists a suspicion that he is one and the same as the Irish Tighernach, Bishop of Clougher and Clones, whose day, however, is, in Wales and Ireland, April 4.

- 17 CYNLLO,
- K C. Wales, circa A.D. 460*

KENELM, *Boy M. Winehambe, in Gloucestershire, A.D. 819 (L.)*.

CYNLLO, son of Mor, was uncle of Pabo post Prydain and of Jalhaiarn. He is tutelary saint of three churches in Radnorshire, and of two in Cardiganshire. He is termed Cynllo the King, and it is probable that he was a chief, who, towards the end of his days, embraced the religious life. His date is about 460. At Llangoedmor, in Cardiganshire, the marks of his knees and the prints of his horse's hoofs are still shown in the rock, also his "brewing tubs" in the rocky bed of the river.

- 18 THENEW,
- W. Scotland, A.D. 574 (L.)*
- .

NINE DAUGHTERS OF S. DONALD, *VV. Scotland, 8th cent. (see July 15)*.

19

- 20 ETHELDWITHA,
- Q. W. Winchester, A.D. 903*
- .

ETHELDWITHA or EALSITHA, widow of King Alfred, was daughter of Ethelred and Eadburg of Mercia. She began the foundation of a convent for women at Winchester along with King Alfred, and after his death she retired into it, but did not survive her husband many years, and died in 903.

21

22

23

- 24 WULFHAD and RUFINUS, *MM at Stone, in Staffordshire*, circa A D 658 (L)
DECLAN, *B. Ardmore, Ireland, 6th cent* (L).

- 25 CYNDEYRN, *C. Carmarthenshire, 6th cent.*
JUDOC, *P H Brittany*, circa A.D. 668 (see December 13).
MORDEYRN, *C Nantglyn, in Denbighshire.*
Translation of S LEWINA, V.M. Seaford, in Sussex,
and at Berg, in Flanders, A.D. 1058

CYNDEYRN was the son of Arthog, of the family of Cunedda, and is not to be confounded with Cyndeyrn or Kentigern, the founder of the bishopric of Llanelwy or S. Asaph

LEWINA was a virgin martyr of whom nothing is known, save that she reposed at Seaford, in Sussex, whence her body was transported to Berg, in Flanders, in 1058. This day is a fair-day in Seaford. The usual miracles were supposed to attend the translation

26

- 27 HUGH OF LINCOLN, *Boy M*, A D. 1255 (L).

- 28 SAMSON, *B Dol, in Brittany*, circa A D. 565 (L).

SAMSON In the text an inaccuracy occurs (viii p 607). When Samson left Wales, it was not merely the vision that induced him to depart, but the fact that the yellow plague was raging there, and also that he was desirous of recovering his patrimony in Armorica.

In the more genuine Life of the saint, the story of his ordination is told quite differently. It was an accident. The bishops, among whom was S Dubricius, were assembled on the Feast of the Chair of S Peter (January 18 or February 22) in the monastery of S German to consecrate two bishops, "but," says the biographer, "according to ancient usage" three bishops were always ordained together, and to make up the third they

consecrated Samson. He did not, as stated in the text, cross at once to Brittany, but to Cornwall, and landed at Padstow, where, as we learn from the Life of S. Petroc, he was visited by that saint. He founded a chapel at Padstow on the height near Place House. Then, we are told, he was visited by and took counsel with a certain Wiman, a monk endowed with the gift of prophecy. Probably this saint accompanied him, he is the Withenoc who was commemorated at Bodmin on November 7, and was the brother of S. Winwaloe, and was founder of Lewannick, near Launceston. From Padstow, Samson made his way, we may conjecture, to Petherwyn, where his cousin Padarn had a large settlement.

Petherwyn was a really extensive territory, and it was afterwards annexed to Tavistock Abbey. And probably it is to this visit that the story belongs of Padarn running to meet Samson with one shoe and stocking on his foot and the other bare. Samson went thence to Southill parish, where he founded the church. It was apparently on his way thither, at Treacor or Tregear, that the incident occurred of the interference with the people who were performing idolatrous rites about a menhir. S. Samson is said to have cut a cross on the stone. The stone has disappeared, unless it be that which bears an inscription to Cumregnus, son of Maucus, and which does carry on it a cross. This stone is nine feet high, and is now in the rectory grounds. The chieftain of the district was Gwedian or Gwythian, and we may suppose that his *tref* was the great manor of Killland, to which in later times S. Samson's was attached.

From Southill, Samson went to the mouth of the Fowey, and founded Golant, whilst his companions, Mewan and Austell, made other foundations near. Probably at this time also he made an excursion to the Scilly Isles, where one has ever since borne his name.

He tarried in Cornwall till the time seemed ripe for him to make a descent on Brittany. He arrived there about 548, and he landed near Dol. On reaching the shore he found there only a poor little hovel, before which sat a man plunged in despair, with his eyes on the sea. Within were two women, his wife and daughter, very ill. The new-comer was able to treat them, so that they recovered, and the man in gratitude offered to Samson any bit of land on his claim that he fancied. Samson searched the "desert" as it is called—that is to say, the wild, uninhabited country—and found an old Roman well choked with earth and overgrown with brambles. He selected the spot, and set to work to establish there his monastery. When, in

550, S. Mewan was sent across country by Samson to Vannes, with a commission, he found the whole country entirely given over to forest and moor, with hardly any population. As the country was so thinly inhabited, the missionary work of Samson must have consisted mainly in planting in suitable positions the several colonies that continued to arrive from Britain. On the left bank of the Couesnon, at no great distance from the mouth, is a great granite basin, nearly five feet in diameter and three feet deep, decorated with eight granite crosses; apparently a font for baptism by immersion. This font is in a village of the commune of Pleine-Fougères, called L'Île Saint-Samson, and it is supposed to date from the mission of the saint. But Samson had not come to Brittany merely to found settlements. The Dumnonian sovereignty had been usurped by one Conmor, and the rightful prince was a refugee at the Frank court.

Samson resolved to obtain his restoration. Leaving his monastery in charge of one of his cousins, he went to Paris, and there endeavoured to persuade King Childebert to take up the cause of the prince, whose name was Judual. The Frank however, would not actively interfere, but he was quite ready to allow Samson and Judual to make an attempt against Conmor. "The more these British fight one another, the less trouble they will occasion me," thought Childebert. So he let Judual go. Samson at once took him off to the Channel Islands, where they collected a band of adventurers and disciplined them, whilst his agents on the mainland did their utmost to rouse the people to revolt. When ripe for action Samson and Judual crossed to Armorica, and many people flocked to their standard. Conmor was defeated in three battles, and killed in 555.

Samson attended the third Council of Paris in 557, and died about 565.

When in the ninth century Nominoë founded Dol as an archbishopric with jurisdiction over all the dioceses of Brittany, the story was invented that Samson had been Archbishop, some said of Menevia, others of York. We find Giraldus Cambrensis in the twelfth century gravely relating that Samson had been Archbishop of S. David's. The connection with York rose out of an error. There was a Samson, son of Caw, who was priest at York, but he was a very different person from Samson, son of Amwn. Then to give the Archbishop of Dol a quasi-official right to bear the pall, it was further fabled that Samson had received this ornament and symbol of authority from the Pope. Accordingly he is usually represented as an archbishop, with crozier and pall. As much misconception exists as to what the

pall implies, a word may here be added relative to it. The pall was originally a part of the dress of the Emperors of Rome, and they specially allowed a few persons to wear it, as, for instance, eminent philosophers whom they desired to favour. Without special license, it was treason to wear the imperial dress. The bishops of Rome received their palls from the emperor as symbols of his favour. When the seat of government was removed to Constantinople, and later, when the Western Empire broke up altogether, then the Popes took it on themselves to grant palls as symbols of good-will. It had no other meaning whatever. It did not symbolise the conferment of archiepiscopal rank. And, indeed, S Paulinus consecrated Honorius to be Archbishop of Canterbury in 627, without having received any pall himself, and Honorius lived as archbishop for seven years before a pall was sent to him. Paulinus, also, received a pall for York in 634, but he had fled from his see before it arrived, and he took it with him to Rochester, and wore it as suffragan to Canterbury till his death.

The earliest and only really trustworthy Life of S. Samson has been tampered with by some later hand, which has introduced a number of miracles that did not exist in the Life when written. But the style in which these latter are composed is smooth and flowing, whereas the original is written in very rugged Latin. It is consequently easy to eliminate all this fabulous matter intruded into an otherwise trustworthy biography.

- 29 LUPUS, *B. Troyes*, A.D. 479 (L.).
 30 ERMENGYTHA, *V. Thanet*, A.D. 680.
 TATWIN, *Abp. Canterbury*, A.D. 734 (L.).

ERMENGYTHA was one of the daughters of Ermenred, King of Kent, and sister of S Ermenburga or Domneva, the foundress of Minster-in-Thalet. Ermengytha retired to her sister's convent, and spent her life there in peace. She does not occur in any early martyrologies or kalendars.

- 31 GERMANUS, *B. Auxerre*, A.D. 448 (L.).
 NEOT, *H. Cornwall*, circa A.D. 877 (L.)

AUGUST

- 1 CENNYDD OF KENNETH, *H Gower, 6th cent (L).*
 ALMEDHA, *VM Brecknockshire, 6th cent (L).*
 SIDWELL OF SATIVOLA, *V.M. Exeter, 7th cent.*
 ETHELWOLD, *B. Winchester, A.D. 984 (L).*

ALMEDHA or ELINED (*see* Life in text) The churches of Llanelien, in Brecknockshire, and of Helland, in Cornwall, are perhaps dedicated to her. There is a parish of Lanhelen, in the diocese of S. Briuc, in Brittany, that was probably dedicated to her originally, though now supposed to have as patroness the mother of Constantine the Great.

SIDWELL or SATIVOLA is said to have been a virgin saint of British origin, and to have had three sisters—Jutwara, whose translation is celebrated at Sherborne on the 13th July, also Eadwara and Willgith, but these are certainly not Celtic names. But Willgith we find as Wulvella or Wilvella at Laneast associated with her sister Sidwell, and I strongly suspect that Eadwara or Jutwara is the Jutwell of Lanteglos. Sidwell is said to have been sister of Paulus Aurehanus. If, as is probable, the church of S Paul at Exeter, which is within the confines of the ancient British city, was founded by Paulus Aurehanus, then it is not surprising to find near it the church of S Sidwell. But in Exeter she is said to have suffered martyrdom, her head having been cut off by a scythe, and then thrown into the well, since reputed holy, in the parish. But it is very doubtful that she was a martyr, and it may be suspected that the symbols of a scythe and well were adopted from her name and originated the fable of her martyrdom. More probably she and her sisters moved west and settled beyond the Tamar. At Laneast, where she and Wulvella are commemorated, is her holy well, called Jordan, whence water is always drawn for baptisms. In one of the church windows is a fragment of stained glass representing Wulvella as a crowned and veiled virgin.

- 2 ETHELDRITHA, *VR. Croyland, circa A.D. 834 (L).*
 PLEGMUND, *Abp. Canterbury, A.D. 914.*

PLEGMUND lived for many years as a hermit. He was one of the preceptors of King Alfred. He was elected Archbishop

of Canterbury, and received consecration at the hands of Pope Formosus. Several sees were vacant at the time, and Plegmund consecrated on one day seven bishops in his cathedral church of Canterbury. He it was who crowned Edward the Elder at Kingston-on-Thames in 900. He died in 914.

- 3 WALTHEOF, *Ab. Scotland*, A D 1160 (L).
- 4 BUAN, *C. Carnarvonshire*, 7th cent.
MOLUA, *Ab Clonfert, Ireland*, A D 606 (L).
- 5 CEITHO, *C. Cardiganshire*, 6th cent (see Nov 1)
OSWALD, *K M Northumbria*, A D. 642 (L).
- 6 ACCA, *B Hexham*, A D 740 (L).
- 7
- 8 FFAGAN, *C Glamorganshire*, 2nd cent.
HYCHAN, *C Denbighshire*, 5th or 6th cent.
ILLOG, *B. Montgomeryshire*, as ELLIDIUS in the Scilly Isles, 7th cent

FFAGAN was, according to the legend, sent by Pope Eleuthesius, with Dyfan, Medwy, and Elfan, to Britain (see *January 1*). He and his companions lived and died in Morganwg, and were not known beyond its limits.

HYCHAN was a son or grandson of Brychan of Brecknock, and is the patron of a church in the vale of Clwyd.

ILLOG or ELLIDIUS is the patron of the church of Hirnant, in Montgomeryshire. He is there commemorated on this day, as also, under the name of Ellidius, in the Scilly Isles, to which he doubtless retired. After the Latin Church had overwhelmed the national Celtic churches, the monks, knowing nothing of the native saints, altered their names to such as were familiar to them, and so S Ellidius became S. Hilary. Not far from Hirnant church is his well, and there is a tumulus close by called Carnedd Illog. According to the Tavistock Kalendar, quoted by William of Worcester, Ellid of Scilly, bishop, was commemorated on the same day as Illog in the Welsh kalendars.

- 9 FEDLIMID, *B Kilmore, in Ireland, circa A.D. 550 (L.)*.
 NATHY THE PRIEST, *C. Achonry, in Ireland, circa A.D. 605 (L.)*.
- 10 GERAINT, *K.M. Devon and Cornwall, A.D. 530*.
 BLANE, *B Bute, A.D. 590 (L.)*.
 BETELLIN, *H. Staffordshire and Croyland, circa A.D. 720 (see September 9)*
 MALCHUS, *B. Lismore, circa A.D. 1130 (L.)*.

GERAINT or GERONTIUS was a chieftain of Devon, grandson of Constantine of Cornwall, and son of S. Erbin or Ervan. He carried on the prolonged agony of struggle against the advancing Saxons. According to local tradition, the ancestral abode of Geraint was at Dinas Geren, *i.e.* the palace of Geraint, near Veryan (*Trans. Roy. Inst of Cornwall*, vol. II. p. 314). His wife Enid, daughter of a chief at Caerleon, is one of the purest and sweetest characters of mediæval romance. If there be any basis of genuine tradition at the bottom of the Mabinoge of Geraint, then the Prince of Cornwall delivered her father from great distress, he having been deprived of his lands and position by an usurping kinsman. Geraint married Enid, and took her home to Cornwall, where his father Erbin, exhausted by old age, resigned the conduct of government to him.

Geraint was so much in love with his beautiful wife that he spent all his time with her and could not bear to be absent from her for a day. Once he was lying asleep, and her tears fell on his breast, and she sighed. She was lamenting that he had thus lost his courage and dignity. But he misunderstood her tears, and believed that she had ceased to love him, and had given her heart to another. So he resolved to go to King Arthur, and he bade Enid run ahead of him and never speak a word on the way, till they reached Caerleon; and he further bade her wear the old and faded dress in which he had seen and loved her. Of the adventures on the way there is no need to tell, till near Caerleon, when Geraint was sore wounded, and in his sickness was nursed tenderly by Enid.

“ Her constant motion round him, and the breath
 Of her sweet tendance hovering over him,
 Fill'd all the genial courses of his blood
 With deeper and with even deeper love,
 As the south-west that blowing Bala lake
 Fills all the sacred Dee.”

And so all his doubt and mistrust passed away, and he loved Enid better, if that might be, than he had before.

“They called him the great Prince and man of men ;
But Enid, whom her ladies loved to call
Enid the Fair, a grateful people named
Enid the Good, and in their halls arose
The cry of children, Emids and Geraints
Of times to be. Nor did he doubt her more,
But rested in her fealty, till he crowned
A happy life with a fair death, and fell
Against the heathen of the Northern Sea
In battle, fighting for the blameless king.”

Tennyson, who composed the “*Idylls of the King*” at Caerleon, in a room overlooking the tidal Usk, did not describe Enid as more typical of a holy and sweet woman than does the old story-teller of the middle ages. Geraint fell in 522, some years before the death of Arthur, at Llongborth, which is doubtless Langport, in Somersetshire. He was possessed not only of an army, but also a fleet in the Severn, and Llongborth signifies the quay for ships. His death is thus described in a poem to his memory by Llywarch the Aged :—

“In Llongborth I saw the rage of slaughter,
And biers beyond all number,
And red-stained men from the assault of Geraint.

In Llongborth I saw the edges of blades in contact,
Men in terror, and blood on the pate,
Before Geraint, the great son of his father.

.

In Llongborth Geraint was slain,
A brave man from the region of Dyvnant [Devonshire],
And before they were overpowered, they committed slaughter.”

A saying attributed to Geraint is, “Short-lived is the hater of the saints” His own designation was, “the Friend of the Saints.”

Geraint is the subject of a tale in the *Mabinogion*, but it is of no historic value.

His sons were Cyngar, Selyf, Iestyn, Caw, and Cado, of whom

four are numbered among the saints, and possibly Tegau Eurfron was his daughter, the virtuous wife of Caradog Freichfras.

Much confusion has arisen through there having been three or four of the same name, princes of Devon.

The first, called by the Latin historians Gerontius, was appointed by the usurper Constantine, in 406, to the command of his army in Gaul. Eventually, mortified in his pride, Gerontius revolted against Constantine, and proclaimed Maximus emperor, but, deserted by his troops and defeated, he put an end to his own life, after having killed his wife and a faithful servant, 408

From him, Gerant, son of Erbin, was removed by more than a century. But, if we may trust the Welsh genealogies, there was about the same time another Gerant, son of Caranog, and father of S Eldad, Bishop of Gloucester.

There was another Gerant again, Prince of Devon, mentioned in a letter addressed to him in 705 by Aldhelm, Abbot of Malmesbury, accordingly nearly two centuries later than the times of Gerant ap Erbin. This last Gerant, at the beginning of the eighth century, fought against Ina, King of Wessex, and was driven back by him into the west, and Ina was able to erect a fortress at Taunton to guard the frontier. The Saxon Chronicle records a battle between Ina and Gerant in 710. A church in Hereford is dedicated to Gerant, the son of Erbin, so also is one in the diocese of Nantes. That of Gerrans, in Cornwall, was founded by him.

S Gérard, in the deanery of Porhoet and bishopric of Vannes, has him for patron.

There was anciently a chapel dedicated to this saint in the parish of Philleigh, in Cornwall, and the inlet or loop of the river Fal was called Polgerran. A headland in Mevagissey bears his name, and on Veryan or Carn Beacon is a mound traditionally held to be his tomb. Excavations made in this barrow in 1855 revealed the remains of a chieftain enclosed in a kistvaen or stone chest. Happily, however, it was not the saintly king who was disturbed, but a prehistoric warrior. The local tradition is that Gerant was a refugee from Wales, driven away by the Saxons, and being well received in Cornwall, fixed on a place called Curgurrell, where he built the castle called after him, Dingeran. After some years he resigned his crown to his son, and was buried in the mound above mentioned, along with a golden boat with silver oars. The treasure seekers in 1855 were sadly disconcerted not to recover these valuable deposits.

II

I 2 MEREWENNA, *V. Marhamchurch, Cornwall.*MUREDACH, *B Killala, Ireland, circa A D 580 (L).*JAMBERT, *Abp. Canterbury, A.D 790*

MEREWENNA is a reputed sister of Morwenna, and a daughter or grandchild of Brychan, of Brecknock She is the patroness of Marhamchurch, near Bude. The Welsh genealogists do not know of her, and we may strongly suspect that she is identical with Morwenna, the foundress of Morwenstow; but Morwenna is also not in the lists of Brychan's children Morwyn, in Welsh, signifies a virgin, and might have been applied to any of his maiden daughters who lived religious lives and founded churches. At Marhamchurch the festival of the foundress is observed on the nearest Sunday to the 12th August

JAMBERT was abbot of S Augustine's, at Canterbury, when chosen successor to Bregwin in that see The time was that when Offa, King of Mercia, was striving to assert his supremacy throughout England. In the anarchy that had succeeded the death of Ethelbald, in 757, the kingdom of Mercia had shrunk to narrow bounds, and Kent, Essex, and East Anglia had thrown off her yoke, while the Welsh were rallying to fresh inroads over her western border. None of the Mercian losses were more felt than that of Kent, for through it ran the main line of communication with the Continent Kent, moreover, was the seat of an archbishopric, to which the entire Church in the Anglo-Saxon realms looked as head. Some years elapsed before Offa could attempt the recovery of Kent, and the Mercian king sought to withdraw the midlands from the supremacy of Canterbury. To effect this, he petitioned Pope Adrian to erect an archiepiscopal throne at Lichfield Adrian consented, and sent the pall to Adulf, the first and only Archbishop of Lichfield and the kingdom of Mercia. This division took place about 786. But, in the meantime, by the battle of Oxford, in 775, Offa had recovered control over Kent Nevertheless, he desired to have the whole of Mercia in independence of Canterbury. Jambert naturally resented this, and Offa seems to have disliked him accordingly. It was not till after the death of Jambert, in 790, that the division ceased, and the archbishopric of Lichfield came to an end. Offa died in 794.

- 14 FACHNAN, *B. Rosscarbery, Ireland, circa A D 590 (L).*
JUST, *C. Cornwall and Montgomeryshire, 6th cent.*

JUST or UST and Dyfnig or Dommicus accompanied S Cadfan from Armorica, and the two in conjunction founded the church of Llanwmm, in Montgomeryshire. The festival of S Just was marked in the old breviary of the abbey of S Melanie, at Rennes, on 2nd September. There was a chapel near this abbey that was dedicated to him, and there is a parish under his patronage in the diocese of Vannes. In Brittany he is held to have been a bishop. But this Just is thought to have been the second Bishop of Rennes, and to have been a martyr. He is also called Justus, and his festival is observed variously on 2nd June and 2nd September. If he ever lived, it must have been in the fourth century, but nothing is known of him. Anyhow, this cannot be the Just of Cornwall and Montgomeryshire. But, indeed, it is most probable that the Cornish saint is not Ust of the Welsh kalendars, and that both are distinct from the saint of Brittany. Probably the Cornish saint Just in Roseland is Iestyn, the Prince of Domnonia, son of S. Gerant, and uncle of S Cybi; brother also of Cado, Duke of Cornwall, and of S Cyngar.

The dedication festival of S Just in Roseland, Cornwall, is on this day. He is not commemorated in the Welsh kalendars.

15

- 16 S. ERMEL, ARMEL, or ERME, *C. Cornwall and Brittany, 6th cent.*

ERMEL or ARMEL, the patron of Plon-ermel, was a Briton, cousin of Paulus Aurelianus or Pol de Léon, and he doubtless accompanied him to Brittany. He was trained by a certain Caron-cinal. A Caron of uncertain date, and reputed to have been a bishop, lived in Cardiganshire (March 5). Or Caron may be Guron, the hermit of Bodmin. All we know is that Ermel, after returning to the world, regretted having done so, and he revisited his director, who advised him to go to Armorica along with his kinsman, Paulus Aurelianus.

The party went over the Severn Sea, and Paul was probably the founder of the church that bears his name in Exeter. Ermel or Arthmael accompanied him when he went farther west. In the deanery of Powder he founded a church now called S Erme. He does not seem to have crossed to Armorica along with S.

Paul, but to have gone independently, and at the head of a separate colony.

Ermel and his companions landed in Lyonesse, at a haven called Aber-Benniguel. At once he organised a *plou* or people, and this bears his name as Plouermel. On account of the disturbances through the usurpation of Connor, Ermel thought it advisable to visit Paris, and crave the protection of Childebert. This was accorded him, and he was granted a bit of land near Rennes, where he founded a *lann*, now S. Armel des Boschoux. He himself lived in a cell. When Connor had been killed, in 555, and Judual was king, he returned to Plouermel. One day he was told that a dragon infested a cave near the river Seich. He at once went to it, bound his stole about it, drew it to the river, and cast the monster in.

He died about 562

In Cornwall, the Latin ecclesiastics, not knowing much, if anything, about him, converted his name into Hermes, and made that saint patron of S. Erme.

17 JAMES, *Deac. at York*, circa A.D. 650 (L.).

18 HELENA, *Empress. W.*, circa A.D. 328 (L.)

DAGÆUS, *B. Inmscathun, Ireland*, circa A.D. 560.

ERNAN, *Ab. B. Ireland*, A.D. 625 (*see MARNOC, October 25*)

INAN, *C Irvine, Scotland, 9th cent.*

DAGÆUS (in Irish, Deghadh) attended S Mochteus in his last illness, and ministered to him the viaticum. He lived in Iniskin, near Dundalk

19 CLEDOG or CLYDOG, *K.M. Brecknockshire, and as CLEATHER in Cornwall*, circa A.D. 482 (L.).

MOCHTEUS, *B. Louth, in Ireland*, A.D. 535 (L.).; also *September 19.*

CREDAN, *Ab. Evesham*, circa A.D. 781.

CLEATHER, founder of a church in North Cornwall, near Launceston, was one of the saintly colony from Brecknockshire, is said to have been a son of Clydwyn, and grandson of Brychan.

This means no more than that he belonged to the clan or family. There was a descent of the Goidels from Brecknock on North Cornwall, and the land was portioned out, so much among the secular tribal chiefs, and so much among the ecclesiastical chiefs. Of these Clether was one. Clether is probably the Clechre of the Life of S. Brynach. Brynach so moved Clechre by his exhortations that he left Carmarthen and went into Cornwall, where he died at an advanced age. At S. Clether is a sacred well, and chapel over it, with an altar in it. Clether is the Cledog or Clydog of the Welsh kalendars.

In a Welsh kalendar of the twelfth century, in the British Museum, November 3 is given as the day of S. Cledog. At S. Clether, October 23 is observed as the feast, because that is the day on which the church was reconsecrated in 1239. There can be little doubt that S. Cleer, near Liskeard, was originally founded by S. Clether. His chapel and well at S. Clether are in a singularly romantic situation. The great Laneast common stands up as a wall to the north; the south slope into the Inney valley bristles with horns of rock, and among these clefts, on a warm, sunny slope, secure from every wind, are the remains of the cell, and chapel, and well of the royal saint. If, as is probable, he was grandson of Brychan and son of Clydwyn, he was there with kinsmen about him. He must be distinguished from Cledog who is said to have died at Clodock, in Ewyas, now in Herefordshire; for this latter was the son of Gwynnar, and father of Cynfarch, from whom Taliesin was descended (Iolo MSS, p. 459).

20 OSWIN, *K.M. Northumbria*, A.D. 651 (L.).

EDBERT, *K. York*, A.D. 768

RONALD, *M. Orkney*, A.D. 1158 (L)

EDBERT became King of Northumbria on the abdication of Ceolwulf, who, after eight years of rule, laid down his sword in disgust and withdrew to a monastery. Edbert and Egbert were sons of Eata, and Egbert became Bishop of York. It was the object now of the Northumbrian kings to detach their realm from Canterbury as much as possible, and to give to York supremacy over Northumbria. Accordingly, Ceolwulf obtained from Rome the recognition of the see of York as archiepiscopal, and his brother Egbert became the first archbishop in 735. In 738 the archbishop's brother Edbert became king, and the joint character of their rule was shown in the "stycas" or copper coins issued

from the mint at York, bearing on the obverse the legend of the king, and that of the primate on the reverse.

"Never had the kingdom shown greater vigour, within or without, than under these two sons of Eata. Edbert showed himself from the outset of his reign an active and successful warrior. Though attacked at the same time on his southern border by Ethelbald of Mercia, he carried on in 740 a successful war against the Picts, and ten years later recovered from the Britons of Strathclyde the district of Kyle, in Ayrshire. So great was his renown that the Frank King Pippin sent envoys to Northumbria with costly gifts and offers of friendship.

In 756 Edbert, allying himself with the Picts, made himself master of the capital [of Strathclyde], Alclud or Dumbarton. But at the moment when his triumph seemed complete, his army was utterly destroyed as it withdrew homewards, only a few days after the city's surrender, and so crushing was this calamity, that two years after it, not only did Edbert withdraw to a monastery and leave the throne to his son Osulf, but the archbishop joined his brother in retirement, till both were laid side by side in the minster at York."¹ (For Egbert see *November 19*).

21

22 GWYDDELAN, *C. Montgomeryshire and Carnarvonshire, uncertain date*

SIGFRID, *Ab Monkswearmouth, A.D. 689.*

ARNULF, *Ab. S. Neots, in Huntingdonshire, 9th cent*

SIGFRID was elected in the room of Easterwin to govern the united monasteries of Wearmouth and Jarrow whilst Benedict Biscop was absent in Rome. He was a man of a delicate constitution, and suffering from lung complaint. When Benedict returned he also was in failing health, and after three years both Benedict and Sigfrid were obliged to resign themselves to their beds in their several cells; they, however, so desired to be together that Sigfrid was carried to where Benedict lay, and was placed in bed with him, and thus the two abbots lay, their heads on one pillow. Sigfrid died two months after, and Benedict sur-

¹ Green, "The Making of England," ed 1897, vol ii p 182 seq. I have merely cleared away the affectation in the writing of Anglo-Saxon names introduced by Freeman, and followed servilely by Green

vived him only four months. They were laid in one grave, A.D. 689.

ARNULF was a hermit living in the fens at the border of Huntingdonshire, in the region of the Gyrwas or Mid-English. The tradition is that he was of British origin. This is not so improbable as it would seem, for the fens proved a refuge for the Britons against their conquerors, and at the beginning of the eighth century they still spoke there the British tongue, as we learn from the Life of S. Guthlac. The name of Arnulf is, however, Scandinavian. His cell was destroyed in an incursion of the Danes. The name of this hermit does not occur in English kalendars, but is inserted here, as in French kalendars an Arnulph, bishop, occurs. The place where the saint had his cell is now called Eynebury or Arnulf's-bury, and is half a mile from S. Neots.

- 23 EOGAIN, *B. Ardstraw, Ireland*, circa A.D. 558 (L.).
TYDFYL, *M. Wales*, circa A.D. 460.

TYDFYL was a daughter of Brychan. The story goes that she with her father, then an old man, and Rhun, one of her brothers, were massacred by a party of pagan Picts and Saxons about 460, at a place afterwards called Merthyr Tydfyl. She was the wife of Cyngen, son of Cadell Deyrnllwg, and the mother of Brochwael Ysgythrog.

- 24 YARCARD, *B. Scotland*, circa A.D. 450 (L.).
25 EBBA THE ELDER, *V. Abbs. Coldingham*, A.D. 683 (L.)
26 PANDWYNA, *V. Eltisley, Cambridgeshire*.
BREGWYN, *Abp. Canterbury*, A.D. 762

PANDWYNA, whose life was written by Richard, rector of Eltisley, from popular tradition, was said to have been the daughter of a petty prince in Ireland or North Britain, who fled to the Cambridge fens to escape from a marriage designed for her by her father. She took refuge with a kinswoman who was prioress of a nunnery at Eltisley. There she lived a godly life, and was regarded as a saint. She was buried near a well, in sublime disregard of sanitary principles, which still bears her name, but was dug up and translated to the parish church in the

fourteenth century. The nunnery in which Pandwyna or Pandania lived was destroyed by the Danes. Eltislew also possessed the relics of S. Wendretha, a personage of whom even less is known than of Pandwyna. Whatever may be the origin of the name Pandwyna, that of Gwendraeth is distinctly Celtic. Notwithstanding the general impression that the Britons were exterminated from the east of England and the Midlands, there are indications that a good many remained. Even the name given to the supposed Angles who occupied Huntingdonshire and Cambridgeshire is suspiciously like a Celtic name Gyrwas (men reduced to slavery).

BREGWYN succeeded Cuthbert as Archbishop of Canterbury, and ruled the Church but three years; he died in 765. It appears to have been considered that investment with the office of Archbishop of Canterbury entitled the occupant of the see to be regarded after death as a saint.

- 27 DECUMAN OF DAGAN, *H.M. near Dunster, Somersetshire, and Pembroke*, circa A.D. 706 (L.)

MAELRUTH, *Mk. M. Mearns*, A.D. 722 *In Irish kalendars on April 21* (L.).

- 28 SAMSON, *B. Dol, in Brittany, and Cornwall*, circa A.D. 565 (L.); *see July 28*

Translation of S. RUMWOLD, Child C. at Brackley, Northamptonshire, circa A.D. 650.

RUMWOLD was of princely race in Northumbria; he was perhaps the son of Alcfrid by S. Kyneburga, daughter of Penda; but this is all very doubtful. The legend says that no sooner was the infant baptized than he at once spake and professed the Christian faith, and died whilst still in his baptismal innocence. But this seems to have grown out of what is probably the truth, that he was baptized as an adult and died shortly after. His death took place on November 3, at King's Sutton, in Northamptonshire, but his body was translated to Brackley, in the same county, on the 28th August, and three years after to Buckingham. The death took place about 650.

- 29 SEBBI, *K.C. East Angles*, A.D. 694 (L.).

- 30 FIACRE, *C. Breuil, 7th cent.* (L.).

- 31 EANSWITHA, *V* *Abss Folkestone*, A D 640 (L)
 AIDAN, *B. Lindsfarne, Ap Northumbria*, A D. 651
 (L).
 CUTHBURGA and QUENBURGA, *VV. Wimborne, in
 Dorset, circa 725* (L).

SEPTEMBER

- 1 SULIEN, *Ab. Wales, 6th cent.*

SULIEN or SILIN is said to have founded churches in Denbighshire and Cardiganshire, and to have spent most of his days in Bardsey. He accompanied S. Cadfan from Brittany. There S. Sulian is commemorated as the son of a Welsh prince, Brocmael. His brother is called Maen, and this may be the Mael who, according to the Welsh, was brother to Sulien. The Sulien known in Wales was son of Hywel ap Emyr Llydaw. No Brocmael is known there, but Brochwael Ysgythiog, Prince of Powys, is perhaps meant. The Breton story is that Sulian entered the religious life at a very early age, in fact, ran away from home and placed himself under the Abbot Gumarch, at Meibot—that is to say, Gwyddfarch, at Meifod, in Montgomeryshire. Gwyddfarch seems to have been the founder of this school, which passed afterwards under S. Tyssilio, son of Brochwael.

The father, very angry, sent to have the abbot killed, but his emissaries did not carry out his orders. Instead, Gwyddfarch dismissed the boy, who crossed the Menai Straits and settled in Bardsey, which took his name as Ynys Sulien. There he remained seven years, till recalled by his old master, who desired to entrust to him the charge of Meifod. On reaching the place, Sulien found that the old man was bent on making a pilgrimage to Rome, and he used his best endeavours to dissuade him from so doing, on account of his advanced age. On the death of Gwyddfarch, Sulien was elected in his room. In the meantime, his father had died, and his brother had succeeded to be head of the tribe. The wife of this brother fell desperately in love with the young abbot, and to escape her he fled. He retired to Bwlth, in Brecknockshire. But still an object of pursuit, he fled still farther, crossed into Brittany, and settled near Aleth, now S. Malo, where he remained till his death, on November 8

according to the S Malo Breviary, but his festival is celebrated on October 1. He was succeeded at Meifod by his brother S. Tyssilio. The Breviary of Léon marks his festival on July 29, and his tomb is shown at Plouer, on the Rance. It is quite possible to reconcile the Breton story with what particulars we know about Sulien. Bardsey was certainly called Ynnys Siln after him, and he founded churches in Denbighshire and Cardiganshire, but not in Brecknockshire. Sulien in Wales is commemorated on the same day as Sultian in Brittany. The date of his death would be about 570. The real discrepancy is in the name of the father. In some Welsh kalendars Sulien is also commemorated on September 2 and October 1; also with S Mael, on May 13.

2

3 **MACRIESS, B. Connor**, A. D. 510 (L.).

4 **MONESSA, V. Ireland**, circa A. D. 456 (L.).

RHUDDLAD, V. Anglesey, 7th cent.

Translation of S CUTHBERT, B., A. D. 995.

RHUDDLAD was a daughter of a king of Leinster who came to Wales and founded a church in Anglesey.

5 **MARCHELL OR MARCELLA, V. Wales**, 6th cent.

MARCHELL OR MARCELLA was the daughter of Arwysth Gloff. She founded Ystrad Marchell, near Welshpool, Montgomeryshire, where the Cistercian abbey of Strata Marcella was afterwards erected. Capel Marchell, in Llanrwst, Denbighshire, is now destroyed.

6 **BEGA, V. Abbs Cumberland**, end of 7th cent.; see also October 31 (L.).

IDLOES, C. Montgomeryshire, 7th cent.

IDLOES was the son of Gwyddnabi, and lived in the early part of the seventh century. In the Welsh proverbial triplets, called "The Sayings of the Wise," he is thus referred to—

"Hast thou heard what Idloes,
A man of meekness, amiable in his life, sang?
'The best quality is a good deportment.'"

- 7 MODOC, *B. Ferns*, CIRCA A.D. 632 (L.).
 DUNAWD, *Ab. Flintshire*, 6th cent
 ALKMUND and GILBERT, *BB. Hexham*, A.D. 780 and
 789 (L.)

DUNAWD FAWR was the son of Pabo Post Prydain, and in early life a distinguished warrior among the North Britons. Later in life he embraced the religious life, and in conjunction with his sons Denniol, Cynwyl, and Gwarthan, founded the celebrated monastery of Bangor Iscoed, on the banks of the Dee, in Flintshire. Dunawd was its first abbot.

- 8 CYNFARCH, *C. Flintshire and Denbighshire*, 5th cent.

CYNFARCH, the son of Meirchion, was a prince of the Northern Britons. He married Nefyn, one of the daughters of Brychan, by whom he had Urien Rheged. He dedicated the latter part of his life to religion. He is probably the author of the saying, "Whoso respects thee not, him respect not thou."

- 9 KIERAN, *Ab. of Clonmacnois*, A.D. 548 (L.).
 WULFHILDA, *Abss. Barking*, end of 10th cent.
 BERTELLIN, *H. Staffordshire*, CIRCA A.D. 720 (L.)

WULFHILDA was of noble Saxon family. She built and endowed the abbey of Horton, on her estate in Dorsetshire. When the abbey of Barking was reconstituted after having been wrecked by the Danes, Wulfhilda was appointed abbess, but at the same time governed her abbey at Horton. In the troubles that followed the death of King Edgar, she was driven away by Elfhrytha, the widow of the king, but was restored by Ethelred. She died about 980.

- 10 FINIAN or FINBAR, *B. Maghbile, Ireland*, A.D. 576.
 FRITHESTAN, *B. Winchester*, A.D. 933

FINIAN, of Maghbile or Merville, was an Irishman of noble birth. He received his education under Colman, of Dromore, by

whom he was afterwards recommended to the Abbot Caylan. This holy man sent him to Whithern, S. Ninian's monastery. Having spent some time there, he is said to have visited Rome, where he spent seven years, and was ordained priest. It is not certain when he founded Maghbile, in Down, but it was about 540, and S. Columba studied under him. He is not to be confounded with Finian or Frigidian, who became Bishop of Lucca. Finian, sometimes called also Finbar, was buried at Moville. He died in 576.

FRITHESTAN was one of the seven consecrated on the same day by Plegmund, Archbishop of Canterbury, and was appointed Bishop of Winchester. He ruled for twenty-three years, and died in 933. Shortly before his death he consecrated Birstan to be his successor.

11 DEINIOL THE CARPENTER, *B. Bangor, in Wales, 6th cent.; also December 10.*

DEINIOL or DANIEL THE CARPENTER was first Bishop of Bangor, and is said to have been consecrated by S. Dubucius in 516. (See also *Life, December 10.*) He was a son of Dunawd, of North Britain, who was driven from his territories and took refuge in Wales, and placed himself under the protection of Cyngen, Prince of Powys. Dunawd and his sons Deiniol, Cynwyl, and Gwarthan embraced the religious life, and founded the celebrated establishment of Bangor, on the banks of the Dee, in Flintshire. When Pelagianism spread in Britain a second time, S. David sent Deiniol over to a certain Paulinus, a bishop, to come from Gaul to the aid of the distracted British Church. A synod met at Llanddewi Brefi, in Cardiganshire, and through the eloquence of Paulinus, supported by S. David, Dubricius, and Deiniol, the truth prevailed. Bede says that Dunawd, the father, was at the conference with Augustine in 602. Daniel must therefore be placed as successor to his father about 608. The date of his death would be 620 or thereabouts, unless, what seems probable, Bede named another Dunawd, as the other circumstances of the life of Deiniol give him an earlier date. The synod at Brefi was before 569, and the slaughter of the monks of Bangor, at Chester, took place in 613. He was buried in Bardsey.

12 AILBE, *B. Emly, in Ireland, A.D. 527 (L).*

13 *Translation of S. AUGUSTINE OF CANTERBURY.*14 TEGWYN, *C. Merionethshire, early in 6th cent.*
TUDY, *C. Cornwall.*

TECWYN or TEGWYN was the son of Ithel Hael, and came to Britain with S Cadfan from Armorica. He was founder of a church in Merionethshire. There was another Tegwy, son of Dingad ab Nudd, but he had no festival.

TUDY is sometimes in the Exeter Episcopal Registers entered as S. Tudus, and sometimes as S Tudia. Among Brychan's supposed daughters was a Tydie. There is a S Tudy venerated in Brittany on May 11. He was a disciple of S Maudez, known in Cornwall as S Mawes, who certainly resided some time in the peninsula. S. Tudy plays no conspicuous part in the legend of his master. He was clearly young at the time, and in Brittany nothing is known of his after life. He is known in Wales as S. Tegwy or Tegwyn, and his festival in Wales is September 14, the same day as that of S. Tudy in Cornwall. This may be taken to establish the identity, and we must dismiss the notion that Tudy was a female saint. His name was made use of for a gross forgery. The archdiocese of Tours claimed jurisdiction over the whole of Brittany, and the Breton bishops resisted this claim. To substantiate it, the clergy of Tours produced a Life of S Corentin, in which it was said that the church of Cornouaille, being without bishops, sent Corentin, Winwalloe, and Tudy to S Martin to be ordained bishops by him, and that S Martin consecrated Corentin to be Bishop of Qumper, and appointed Winwalloe and Tudy to their monasteries as abbots. But, unhappily for the composer of the story, S Martin had been dead a century before these saints lived.

S. Tudy founded the monastery of Loc-Tudy, and was the apostle of the south-west of Cornouaille. It is to be regretted that, except for a few incidents of his life in the legend of S. Maudez, nothing further is known of him. At some period of his life he, as also his master, Maudez, were in Cornwall, where he founded his *lann*, where is now the church that bears his name, whilst Maudez lived an eremitical life near the spot where rose later the castle of S. Mawes.

15 MERRYIN OR MEADHRAN, *B. Ireland and Scotland, A.D.*

- 16 NINIAN, *B of the Eastern Picts*, circa A.D. 432 (L)
 AUXILIUS, *B Ireland*, A.D. 454.
 LAISREN, *Ab Iona*, A.D. 605
 EDITH, *Abss Polesworth*, circa A.D. 964 (L).
 EDITH, *V Wilton*, A.D. 984 (L).

AUXILIUS In or about 432 S. Patrick, on his return to Ireland from Rome, summoned to his aid two missionaries, named Auxilius and Iserninus. Probably he picked them up on his way. They would not have been of much use to him had they not been fluent speakers of the Celtic language, and we may assume that they were Celts, either from Armonca, Cornwall, or Wales. All we know of his career was that he passed through Auverre and Evreux, and probably sailed for Britain from the mouth of the Seine. Probus says that he crossed the country without stopping long on the way; but other writers assert that he spent some time in the country, and that he visited Menevia. There is a chapel near S. David's Head bearing the title of S. Patrick. Moreover, according to Welsh tradition the apostle of the Irish had been there before the birth of David. It is quite probable that he did go by the Via Julia to the old port of Menevia, whence the Irish coast can be seen in clear weather, and there took ship for Ireland. This will agree with what we learn, that he landed in Wicklow, but being repulsed by the natives, was obliged to take ship again, and finally came ashore in the Bay of Dublin.

We may presume that Auxilius and Iserninus were with him, unless summoned later.

About 456 Patrick held a synod, which was attended by Auxilius and Iserninus, and which drew up canons that are still extant. Auxilius died in 459, according to the Annals of Ulster; but the Four Masters give as the date 454—that is, actually 455—in which case the synod must have been about 454.

In the Martyrology of Gorman, Auxilius or Usaille is given on February 7. In the Book of Obits, of Christ Church, Dublin, his day is October 19. Colgan collected what notices he could of him as commemorated on March 19, and tells us that some martyrologies gave as his feast April 16, and again September 16. In the Martyrology of Tallaght is the entry on March 19, of Auxilius, "companion of S. Patrick and bishop." The Annals of the Four Masters give as the day of his death August 27.

17

18 *Translation of S. WINNOC (see November 6).*19 THEODORE, *Abp. Canterbury*, A.D. 690 (L.)

20

21 MABYN, *C. Cornwall*, circa 560

MABYN or MABENNA is a person unknown. It is much more probable that the church of Maben, in Cornwall, was founded by Mabon, the brother of S. Teilo, and the founder of the church of Llanfabon, in Wales. In Llandeilo Fawr there are two manors, one called that of Teilo, and the other the manor of Mabon. These were probably grants made by the King of Dynevor to the two brothers. In Cornwall Mabyn is supposed to be a maiden saint, but a mistake of gender is not uncommon where the history of the founder has been lost. There was another S. Mabon, son of Tegonwy ab Teon, to whom Ruabon church, Denbighshire, is dedicated.

22 LOLAN, *B. Scotland*, 5th cent (L.).23 *Ordination of S. PADARN*ADAMNAN, *Ab Iona*, A.D. 704 (L.).TEGLA, *V. Wales (see June 1).*24 MWROG, *C. Anglesey and Denbighshire*, uncertain dateROBERT, *H. Knaresborough*, A.D. 1218 (L.)25 CAIAN, *C. Anglesey*, 5th cent.FINBAR, *B. Cork*, A.D. 623 (L.).CEOLFRID, *Ab. Wearmouth*, A.D. 716 (L.).

CAIAN was son or grandson of Brychan, of Brecknock. He founded the church of Tregaiian, in Anglesey.

- 26 **ELFAN**, *C. Wales, 2nd cent.* (see **ELVAN**, January 1).
MEUGANT, *C. Anglesey, Denbighshire, Monmouthshire, and Brecon, 6th cent.*

MEUGANT, or **MEIGAN**, or **MAUGHAN**, was of princely descent, and a member of the college of S Illyd, from whence he removed to that of S Dubricius at Caerleon, to be with his father, Gwyndaf the Aged, who was abbot there, and probably to assist him in his charge. He is believed to be the same as **Maucannus**, Bishop of Silchester, in Hampshire, and to have been driven from his see by the incursions of the Saxons. He must have retreated into Cornwall, where are two churches of his foundation, S Mawgan, in the lovely vale of Lanherne, a church of singular beauty, and another in Kerrier. At the latter he is represented, on the keystone of the tower window, as a bishop with staff and mitre. In old age he retired to that Isle of Saints, Bardsey, where he died and was buried. There was another S Meugant, son of S. Cyndaf.

27

- 28 **MACHAN**, *B. Scotland.*
CONVAL, *C. Scotland, circa A.D. 630.*
LIOBA, *V. Abs. Bischoffsheim, circa A.D. 779 (L.).*

MACHAN was early sent from Scotland to be trained in Ireland. On his return to Alba he was ordained priest, dedicating himself to the Lord as some expiation for the crimes committed by his parents. He went to Rome, where he was consecrated bishop. In the Aberdeen Breviary is a wonderful story of how some oxen of his that were stolen by robbers were, at his prayer, turned into stone. His date is uncertain.

CONVAL, son of an Irish prince, became a disciple of S. Kentgern. He mounted on a stone and used it as a ship to convey him from Ireland to Alba, and he landed in the Clyde. The stone was long after regarded as possessed with miraculous powers. He died about 630.

- 29 **RICHARD ROLLE**, *H. Hampole, near Doncaster, A.D. 1349.*

RICHARD ROLLE was born at Thornton, near Pickering, and under the patronage of Thomas Neville, Archdeacon of Durham, was sent to study at Oxford. At the age of nineteen a desire

came on him to live the life of a recluse. On his return home he patched up, with the assistance of his sister, a habit suitable for a hermit, and ran away from home. On the eve of the Assumption he arrived at a little village church, where his devotion struck the lady of the manor, the wife of John Dalton, and one of her sons recognised him, having seen him at Oxford. Next day at mass, the young hermit, having obtained permission from the priest, mounted the pulpit and preached a respectable sermon. John Dalton invited the boy home to dinner, and after the meal had a chat with him, and finding the youth had quite made up his mind to live as a hermit, he gave him a cottage on his estate. There he remained for many years, writing a good deal, and in his old age he moved to Hampole, where he died in 1349.

30 NIDAN, *C. Anglesey and Scotland*, circa A D 620.

ENGHENEDL, *C. Anglesey*, 7th cent.

HONORIUS, *Abp. Canterbury*, A D. 653 (L.).

NIDAN was the son of Gwrfyw, the son of Pasgen, and was confessor to the saints at the college of Penmon, in Anglesey. He lived in the first part of the seventh century.

ENGHENEDL was the son of Cynan Garwyn, the son of Brochwel Ysgythrog. A church in Anglesey was dedicated to him. He lived in the early part of the seventh century.

OCTOBER

1 MELOR, *M. at Amesbury*; see January 3 (L.).

2 KEA, *Ab. B. Cornwall and Brittany*, 6th cent. (see November 5).

THOMAS CANTILUPE, *B. Hereford*, A.D. 1282 (L.).

3 EDMUND, *C. Scotland*, circa A.D. 1100.

EDMUND, son of Malcolm Ceanmore and S Margaret. He conspired with Donald Bane in an attempt to regain the Scottish crown from Duncan II., who was treacherously slain at Mordun, on the banks of the Bervie. After a three years' restoration, in which it is hard to say what share Edmund had in the

government, Edgar Atheling succeeded in enthroning his nephew Edgar, son of Malcolm, and in mutilating and imprisoning Donald Edmund, probably, hardly voluntarily betook himself to the Cluniac monastery of Montague, in Somersetshire, where he spent the rest of his days in the exercise of great austerities, and begged that he might be buried in chams. He died about 1100

- 4 CYBI, *Ab. Cornwall and Wales; see November 8 (L).*

Cubert Feast is on this day. The church of S Cubert, Cornwall, was undoubtedly dedicated originally to S. Cybi, and rededicated to S. Cuthbert.

- 5 CYNHAFAL, *C. Denbighshire, early in 7th cent*
MURDACH, *H. Argyleshire, date uncertain.*

CYNHAFAL was the son of S. Elgud, of the family of Caradog Freichfras. There is a poem by a fifteenth century Welsh bard that gives an account of a miracle performed by him upon Benlli the Giant, after whom the eminence Moel Fenlli, near Llangynhafal, is called. He tortured the giant, filling his body with agony and wildfire, which drove him to seek relief in the cool waters of the river Alun, which, however, refused its aid, and became dry thrice, retreating into the rock, so that the giant was consumed by heat, and left his bones on the bank. Nennius attributed the destruction of Benlli to the great S. Germanus.

- 6 CUMINE THE WHITE, *Ab Iona, A.D. 669, also February 24 (L).*

FAILBHE, *Ab Scotland, date uncertain (L).*

YWI, *Deac C. Wilton, end of 7th cent (L).*

MACCALLEN, *Ab. Waalsor, A.D. 978 (L).*

MALCHUS, *B Lismore, A.D. 1125.*

- 7 CYNOG OR CANOG, *M. Wales, circa A.D. 492.*

DUBTACH, *Abp. Armagh, A.D. 513.*

OSYTH, *V.M. in Essex, end of 7th cent. (L).*

CYNOG OR CANOG was the eldest son of Brychan, of Brecknock. Shortly after his birth he was committed to a holy man named Gastayn, by whom he was baptized. He is believed to have been murdered by Saxons at Merthyr Cynog, in Brecknockshire, in or about 492. This must have been in a piratical

incursion The *torque* or collar that his father gave him at his baptism was preserved at Brecon amongst its precious relics in the time of Giraldus Cambrensis There are several churches in Wales dedicated to him, mostly in Brecknockshire There is a church in Brittany that may bear his name, S. Cenneur, in the diocese of S. Malo.

DUBTACH succeeded Cormac in the see of Armagh in 497 Little or nothing is recorded of him, except that he ruled the see for sixteen years, and died in 513

- 8 CEINWEY, KAINWEN, OR KEYNE, *V. Wales and Cornwall*, circa A.D. 490 (L.).

TRIDUANA, *V. Scotland, uncertain date* (L.).

- 9 CADWALADR, *K.C. Anglesey, Denbighshire, and Monmouthshire*, A.D. 664; also November 24

CADWALADR, son of Cadwallon, was the last of the Welsh princes who assumed the title of chief sovereign of Britain. His power, however, was very limited, as Oswald the Bernician, after the defeat and death of Cadwallon, is said to have extended his sway over the Welsh as well as over the Saxons After a few years, Penda, of Mercia, revolted, and Oswald was killed in battle; and then, probably, the Welsh for a while recovered their independence. Cadwaladr would seem to have been of a quiet disposition, or else the British were too exhausted by their losses under Cadwallon, his father, to continue the struggle. A great plague broke out in Britain, and Cadwaladr rather ignobly ran away to Armorica to escape it. This was in 664; and notwithstanding his flight, he died of the pestilence. There has been some curious alteration of facts relative to the history of the reigns of Cadwaladr and Cadwallon, concerning which see Skene's "Four Ancient Books of Wales," 1 73-75. That Cadwaladr went on pilgrimage to Rome is a fiction, due to the confusion between him and Ceadwalla.

- 10 ERVAN, *C. Cornwall* (see ERBIN, May 29).

TANWG, *C. Mervonethshire, early 6th cent.*

PAULINUS, *B. York, A.D. 644* (L.).

TANWG was one of the sons of Ithel Hael, who accompanied S. Cadfan from Armorica to Wales He became a member of the college of Bardsey.

- 11 CAINECH OF KENNY, *Ab Ireland*, circa A.D. 599 (L)
 ETHELBURGA, *V. Abbs. Barking*, 7th cent (L)
- 12 FIECH, *B. Sletty, Ireland*, end of 6th cent. (L.)
 EDWIN, *K. Northumbria*, A.D. 633 (L)
 WILFRID, *B. York*, A.D. 709 (L).
- 13 FYNCANA and FINDOCHA, *VV. Scotland*, 8th cent (L)
 COEMGEN OF COMGAN, *Ab. Scotland*, 8th cent (L)
Translation of S. EDWARD THE CONFESSOR, A.D. 1163
 (L).

14 MANACCUS, *Ab Cornwall and Anglesey*, 6th cent

MANACCUS, bishop and confessor, according to William of Worcester, was buried at Lanlivery, in Cornwall. This is Mygnach, the son of Mydno, of Carnarvon, who was for some time registrar of the college of S. Cybi at Holyhead, and afterwards abbot. A dialogue in verse between him and Taliesin is published in the Myvyrian Archaeology, where he is called Ugnach. As his friend and master came to Cornwall, it is probable that he followed, and we have at least one church of his foundation in the peninsula; though it must be admitted that though Lanreath is at a great distance from Manaccan, it is conceivable that the S. Manacca there commemorated may be the same saint; but it is also possible that Manaccan is a misunderstanding of the Cornish *mynach*, a monk. The other name for the place is Minster, and it was a monastery.

- 15 LEVAN, *C. Cornwall* (see June 7)
 TUDUR, *C. Montgomeryshire and Monmouthshire*, late
 6th cent
 BROTHEN, *C. Merionethshire*, 7th cent.

TUDUR was one of the sons of Arwystli Gloff, or "the Lame" He was brother of Tyfrydog, Dibeufyr, Tyrnog, Twrog, and Marchell. He is said to have been buried at Darowam, in Montgomeryshire, and belongs to the latter half of the sixth century.

BROTHEN was a son of Helig ab Glanog. He and his brothers embraced a religious life when their territory was overwhelmed by the sea.

- 16 COLMAN, *B. Kilruadh, Ireland, 6th cent* (L)
 GALL, *HC Switzerland, circa A.D. 645* (L).
 KIARA, *V Kilrea, Ireland, A.D. 680* (L)
- 17 *Translation of SS. ETHELRED and ETHELBERT, MM*
Ramsey, Huntingdonshire, A.D. 670 (L)
Translation of S. ETHELDREDA, V. Abbs Ely, A.D. 679
 (L)
 NOTHELM, *Abp. Canterbury, A.D. 740*
 REGULUS OR RULE, *B. Scotland, 8th cent* (L)

NOTHELM was a priest of the church of London when chosen to succeed Tatwin as Archbishop of Canterbury. He afforded help to Bede in the compilation of his ecclesiastical history, by collecting traditions relative to S. Augustine and his companions, and afterwards, when in Rome, by copying various letters of the Popes, and other documents relating to England; thus we really owe to this prelate a deep and indelible gratitude for the pains he took, and for his appreciation of the importance of the work undertaken by Bede. He corresponded with S. Boniface in Germany. He died in 740. Many of the early archbishops leave names, and names only, in the history of the church of Canterbury, but this is not the case with Nothelm.

- 18 GWEN, *WM. Wales, circa A.D. 492*
 BROTHEN and GWENDOLINE, *CC. Wales, 7th cent*
 (L).

GWEN was daughter or granddaughter of Brychan, and wife of Llyr Merini, by whom she was the mother of Caradog Freichfras. She was murdered by the pagan Saxons at Talgarth, in Brecknockshire, about 492. No day is given her in the Welsh calendars.

She is not to be confounded with S. Gwen or Wenn, the wife of Selyf, Duke of Cornwall, and mother of S. Cybi, who belongs to the same period, and who founded a church in Cornwall.

Challoner gives on this day S. Gwendoline, as a festival in Wales; but S. Gwyddelan is commemorated on August 22. Possibly he means S. Gwen.

- 19 ETHBIN, *H Ireland, 7th cent (L.)*.
FRIDESWIDE, *V. Abss Oxford, circa A.D 735 (L)*
EADNOTH, *B.M. Dorchester, A.D 1016*
- 20 BRADAN, *B Isle of Man, 7th cent (L)*
FINTAN MOELDUBH, *Ab. Clenenagh, A.D 625.*
ACCA, *B. Hexham, A.D. 740 (L.)*.
- 21 TUDWEN, *C. Wales, end of 7th cent*
FINTAN MUNNU, *Ab. Taghmon, Ireland, A.D 635 (L.)*.
- 22 NWYTHON OR NOETHAN, *C. Denbighshire, 6th cent*
GWYNNOG, *C. Wales; Welsh kalendars on 22nd and
23rd (see October 26).*

NWYTHON OR NOETHAN was the son of Gildas y Coed Aur, and he and his brothers Dolgan, Cennydd (Kenneth), and Gwynnog were members of the colleges of Illyd and Cadoc. Two chapels founded by Gwynnog and Nwython formerly existed near the church of Llangwm, in Denbighshire. In the earlier Welsh kalendars both saints are commemorated on the same day, but Rees gives Gwynnog on October 26.

- 23 CLEATHER, *K.M Cornwall and Wales; see August 19
(L)*
COLUMBA, *V.M Cornwall (see November 13)*
ELFLEDA, *W Glastonbury, middle of 10th cent (L.)*.
- 24 CADFARCH, *C. Montgomeryshire, 6th cent. (L.)*.
MAGLORIUS, *B. Dol, in Brittany, A.D. 486 (L.)*.
- 25 CAIDAN, *C. Ireland, 6th cent.*
MARNOC, *B Kilmarnock, Scotland, circa A.D. 625;
also March 1, and ERNAN, August 18*

MARNOC OR MARNAN is identified in the Irish kalendars with Ernan, who sought to touch the hem of S. Columba's garment at Clonmacnoise, that is to say, Ma or Mo-Ernan or Ernog, the

ma or *mo* being a prefix indicative of affection He was for some time in Scotland, where he founded many churches He died at Tighernach in 625, and was there buried Nevertheless, the Aberdeen Breviary informs us his head was preserved at Kilmarnock, where it was washed every Sunday, and the water in which it had been washed was distributed, for a gratuity, to sick persons, to their great advantage In Ireland he founded or governed Rathnew, in Wicklow. There he is venerated on August 18

26 GWYNNOG OR WINNOW, *C. Wales and Cornwall, 6th cent. (L.)*

ANEURIN, *C. Wales, 6th cent. (L.)*

EADFRID, *C. Leominster, CIRCA A D 675.*

EATA, *B. Hexham, A D 685 (L.)*

CUTHBERT, *Abp. Canterbury, A D 758*

GWYNNOG, grandson of Caw, founded churches in Brecknockshire, and Glamorganshire, and Montgomeryshire He is called Gwynno, as well as Gwynnog

He was son of S. Gildas, and must have settled in Cornwall, where he is known as Winnoc, and Pinnock, and Winnow. He was a disciple of S Cadoc, and when this latter saint came to Cornwall and settled near the Fowey river, where already was a plantation of Veep, his aunt on his father's side, there he established a *Ilan*, now called Langunnet. He seems to have established a large ecclesiastical tribe, as he had churches at S Winnow, S. Pinnock, and Boconnock (Bodd-Gwynnoc). When S. Samson, son of Amwn Ddu, came to Cornwall on his way to Brittany, after having visited S Petrock, we learn that he was visited by Winnoc This, however, was a different saint, Gwethenoc, founder of Lewannick. Llanwnog, in the county of Montgomery, claims Gwynnog for its founder, and in the chancel window he is represented in stained glass in episcopal habit, mitred, and a pastoral staff in his hand; beneath is an inscription, which, when the window was perfect, ran: "Sanctus Gwnocus, cujus animæ propitiatur Deus Amen." It is of the fourteenth century.

EADFRID was a Northumbrian priest who visited Mercia, and effected the conversion of Merewald, the king of the Hwiccas. He founded the priory of Leominster. Merewald was the brother of Wulfhere, and is himself regarded as a saint. He had

been appointed by his brother under-king over the region represented now by Herefordshire, the British kingdom of Ewias

CUTHBERT was the fifth Bishop of Hereford, and thence he was translated to the archiepiscopal see of Canterbury. He corresponded with S Boniface, and at his instance King Ethelbald convened the synod of Cloveshoe. He governed the church at Canterbury for seventeen years, and died in 758

- 27 IA and BREACHA, *VV. Cornwall, 6th cent* (L.)
 ODVAN, *Ab Melrose, A D 563* (L.)
 ABBAN, *Ab. Magharnoid, Ireland, 6th cent* (L.)
 COLMAN, *Ab. Ferns, Ireland, A.D 632* (L.)
- 28 DORTHEN, *Ab. Iona, A.D. 713* (L.)
 ALFRED THE GREAT, *K.C England, A D. 901*
 EADSIN, *Abp Canterbury, A D 1050*

ALFRED THE GREAT, by some strange disregard, has not been inscribed authoritatively in the kalendars of the Church; but if any Englishman merited inclusion it was he, towering above many nobodies whose claims we cannot now adjudicate upon. Certainly it is strange that a bloodthirsty ruffian like Ceolfred, and mere feeble sanctimoniousness like Edward the Confessor, should be included, and not the greatest of Anglo-Saxon kings. He is in Wilson's Martyrology, of 1608, and in that of Father Stanton, of 1887.

EADSIN was chaplain to the Danish King Harold, and was consecrated Bishop of Winchester. When the Danish line closed with the death of Hardicanute, Eadsin had the satisfaction of crowning Edward the Confessor. On the death of Ethelnoth he was raised to be Archbishop of Canterbury, but failing health obliged him to resign some years before his death. He died in 1050.

- 29 COLMAN MAC DUACH, *B. Connaught, beginning of 7th cent.* (L.)
 KENNERA, *V. Galway, date unknown* (L.)
 SIGEBERT, *K.M. East Angles, A.D. 637* (L.)
 ELFLIDA, *V. Abss. Rumsey, in Hampshire, A.D. 1030*
 (L.)

ETHELNOTH, *Abp. Canterbury*, A.D. 1038.

ETHELNOTH was dean of the cathedral church of Canterbury, and he deserved to be entitled "the Good." Ethelnoth was advanced to be archbishop on the death of Living. He translated the relics of S. Alphege, and received the pall from Benedict VIII. He governed his church for about eighteen years, and died on 29th October 1038.

30 TALARICAN, *B. Scotland*, 6th cent

FOILAN, *B. Fosses*, A.D. 655 (L).

ARILDA, *V.M. Gloucester*, date unknown.

ISSUI or ISHAW, *M. Wales*, date unknown.

TALARICAN was a purely Pictish saint, it is believed, although the Aberdeen Breviary says he was an Irishman; but he is unknown to Irish historians. He is said to have been consecrated by Pope Gregory, and he was noted to have celebrated the liturgy daily. He laboured in the north of Scotland, and founded churches in the dioceses of Aberdeen, Moray, and Ross. S. Tarkin's Well is in Kilsyth. There is a church in Skye dedicated to him, so that apparently he extended his missionary labours so far. He probably died about 580.

31 DOGFAEL, *C. Pembrokeshire*, 6th cent (see June 14)

BEGA, *V. Cumberland*, circa 660, also September 6 and November 1 (L).

NOVEMBER

1 RHWYDRYS, MORHAIARN, PEULAN, *CC. Anglesey*, 6th and 7th cents

CLYDWYN or CLEDWYN, *K. Brecknock*, circa A.D. 490.

DINGAD, *C. Wales*, 5th cent.

GWYN, GWYNNO, GWYNNORO, CELYNIN, and CEITHO, *CC. South Wales*, 6th cent.

AELHAIARN, *C. Carnarvon and Montgomery*, end of 6th cent

GWENFYL and CALLWEN, *VV. in Wales, 5th cent.*

GWYNLLEN, *C. Cardiganshire, 6th cent.*

CLYDAI, *V. Pembrokeshire, 5th cent.*

CADFAN, *Ab. Bardsey, 5th and 6th cents.*

The Reconciliation of PADARN.

CYNDDILIG, *C. Somersetshire, late 6th cent.*

BEGA, *V. Cumberland, A.D. 660 (L.).*

THE DYFRWYR, *CC Wales, 6th cent.*

DONA, *C. Anglesey, early 7th cent.*

GWRYD, *a Friar, in Wales.*

There are in all over twenty Welsh saints commemorated on this, All Saints' Day, in the calendars

RHWYDRYS was an Irishman, a son of Rhwydri or Rhodrem, King of Connaught, who came to Wales at the end of the seventh century and settled in Anglesey. Morhaiarn was also a saint in the same island. Peulan, son of Paul Hên, or Paulinus, of Whitland, also settled in Anglesey in the early part of the sixth century.

CLYDWYN or CLEDWYN was the eldest legitimate son of Brychan, according to some authorities. On the death of his father, in or about 450, Brecknock was divided between him and his brother, Rhun Dremrudd. The latter took the eastern and most fertile portion, and left the barren, mountainous region to Clydwyn. The latter was a warlike prince, but of him very little is known. He was probably engaged all his time in fighting against the Irish Picts, who were occupying the seaboard and pushing inland up the valleys. Llangledwyn, in Carmarthenshire, was founded by him.

DINGAD was brother of Clydwyn, and in his old age entered the congregation of S. Cadoc. He is said to have been burned at Llandingad or Dingstow, in Monmouthshire.

GWYN, GWYNNO, GWYNNORO, CELYNIN, and CEITHO were the five sons of Cynyr Farfdrwch, of the family of Cunedda. They are reported to have been all born at a birth. Their father was prince at Caio, and probably occupied the fortress on the hill above the old Roman gold-mines of Gogofau. There was a church, a daughter church to Caio, dedicated to the five saints, Pumpsant; but there is another as well near Cynwyl Elfed, in Carmarthenshire; and Ceitho founded one at Llan-

geitho, in Cardiganshire, where he was also commemorated on August 5.

Probably their father made a grant of land to S. Cynwyl when he came there, and this saint planted his church on a tongue of land hard by, and gained an archi-priestal authority over a very large region, the rich broad basin of the Cothi. The five brothers, who were older than he, probably placed themselves entirely under his direction, as their two foundations are found near his, and also occupying a subsidiary position.

The story goes that in a storm of thunder and lightning they took refuge under a rock in one of the adits of the old Roman mine, laid their heads on a stone pillow and fell asleep, and are there still sleeping, not to wake up till either King Arthur reappears or a truly spiritual and apostolic prelate occupies the throne of S David. They have worn the stone into hollows with their heads, and turned it three times, till each side is marked with depressions. This pillow they cast away, to take another, and it has been set up near a great tumulus at the entrance to the mines and to Dolaucothi grounds. They lived in the sixth century. An inquisitive woman named Gwen, led by the devil, sought to pry on the saints in their long sleep, but was punished by being arrested in the cave, there ever to remain, save when there is storm and rain, when her vaporous form may be seen sailing about the old gold-mine in the air, and her sobs and moans are borne far off on the wind.

ÆLHAIARN was the son of Hygarfael, and brother of SS. Llŵchafarn and Cynhafarn. He was of a royal family, and his grandfather, Cyndrwyn, was prince of a part of ancient Powys. The valorous Cynddylan was his uncle. Aelhafarn founded a church in Merionethshire, and another in Montgomeryshire.

GWENFYL was one of the granddaughters of Brychan. Chapel Gwenfyl, founded by her, formerly existed in the parish of Llanddewi Brefi, in Cardiganshire.

CALLWEN was of the family of Brychan, and founded a church in Brecknockshire.

GWYNLLEU was son of Cyngar, of the family of Cunedda, and is supposed to have founded Nantcwnlle, in Cardiganshire.

CLYDAI was a daughter of Brychan.

CADFAN, eminent among Welsh saints, was commemorated on this day in Wales. He was a native of Armorica, and was the son of Eneas Lydewig, by Gwentairbron, a daughter of Emyr Llydaw, who was remarkable for having three breasts. He came over to Wales about the year 516, along with several others, in consequence of one of those dynastic revolutions

that occurred in every generation in Brittany as in Wales, owing to the distribution of lands and princely rights among all sons equally. His three-breasted mother was twice married, once to Eneas, and again to Fragan. By Eneas she had Cadfan, and by Fragan she had S Winwaloe. The refugees in Cornwall and Wales, not having any tribal rights there, devoted themselves to religion, and were by this means ingrafted into one of the saintly or ecclesiastical tribes. Cadfan became first abbot of the monastery of Bardsey, after it had been founded by Einion Fremm. He has been considered the tutelary saint of warriors. He founded churches, Llangadfan, in Montgomeryshire, and Towyn, in Merionethshire. Towyn has been celebrated in a poem written in the thirteenth century, in which the author commends the church for its choir, its sanctuary, its music, its warriors, and its waters of grace; as likewise for possessing three altars, one dedicated to S. Mary, the second to S. Peter, and the third—"happy was the town to possess the privilege of having it, for it was sent down by a hand from heaven," and was dedicated to S. Cadfan. He is called Catmon in the Life of S. Padarn. He is buried in Bardsey. Towyn claims his body, but this is due to a mistake, a misreading of a stone once standing there.

It is much to be regretted that no Life of this illustrious saint exists.

PADARN. The story of S. Padarn demands closer attention than has been accorded to it in the text; but the legend has been subjected to examination by M. de la Borderie (*Saint Paternus*, Vannes, 1893).

In the first place, it must be remembered that there were three of the name of Paternus—one Bishop of Vannes, consecrated in 465, another Bishop of Avranches, whose life was written by Fortunatus, and who was born at Poitiers about 480, and ruled as Bishop of Avranches from 552 to 562, and subscribed the canons of the third Council of Paris in 557. The third Paternus was son of Pedrwn and Gwen, and was akin to S. Samson, was contemporary with King Arthur, and belongs to the first half of the sixth century. It must be remembered that the legend we have dates from the eleventh century, and the difficulty it provokes is that it has confounded Paternus of Vannes of the second half of the fifth century with Padarn who lived half a century later.

According to the legend, Padarn's parents came from Armorica to Wales—in fact, fled from fear, in one of the dynastic revolutions so common there. With them went the brothers of

Pedwrn ; and they settled in Morganwg, and several married daughters of Tewdrig, king of the country

Padarn was trained for the religious life in Ireland, to which his father had retired and where he had become a monk. When his education was complete he came into Britain with the purpose of returning if possible to Armorica. Among his disciples were three who were his cousins, variously called Hetinlau, Catman, and Titechon, or Tinlatu, Cathinam, and Techo, as they stand in the S. Malo Breviary. In Cardigan he founded the great monastery of Llanbadarn, which was for a while an episcopal see. If we may trust the Latin hexameters of John ap Sulien, son of one of the pre-Norman bishops of S. David's, he ruled there for twenty-one years. At the end of this time he departed, and with his departure the difficulty about his further movements begins. The legend takes him at once to Brittany along with Caradog Freichfras, one of Arthur's great warriors, who promised him the bishopric of Vannes. He therefore made provision for the good government of his establishments in Cardigan by confiding them to well-approved men, and then he departed for Armorica, where he was invested with the bishopric of Vannes. However, his taking possession of the see displeased the other bishops of Brittany, especially S. Samson, the metropolitan, and Samson started to make the round of the episcopal sees, receive the tribute due to him as primate, and the allegiance which he demanded.

As he approached Vannes he sent word to Padarn that he was coming, and he did so to test his humility, and he required him to come and meet him just as he was.

The messenger of Samson found Padarn in the act of clothing himself. He had drawn on one stocking and one shoe. Instantly he ran out to meet his cousin, with one leg bare and the other clothed. When Samson saw his ready mind he rejoiced, and for ever exempted the diocese of Vannes from paying dues to the archdiocese of Dol. Then the seven bishops of Brittany assembled on a mountain, and Padarn with them, and they took a solemn vow to remain united in one faith and one order of government. This agreement of the seven bishops is commemorated by a festival called the Reconciliation of Padarn, which is observed on the 1st November.

But after a while, finding himself still an object of envy, Padarn resigned his see and departed to the territory of the Franks, where he died on the 15th April. The Bretons celebrate three festivals in honour of the saint—one on the day of his death ; one on that of his consecration as bishop, on the

20th June; and one on the reconciliation of the bishops of Llydaw (Armorica), on the 1st November.

Now, in this extraordinary story we see an attempt to fuse into one the Paternus of Vannes of 465 with the Padarn of, say, 525; and by his retreat into the land of the Franks is probably intimated that he was made Bishop of Avranches, 552-562

The writer of the eleventh century was himself perplexed. He had most assuredly old material at his disposal relative to Padarn, and he tried to accommodate what he found with what he had also heard, that there was a Paternus of Vannes

Now, there is an element in the life of S Padarn that has not hitherto been regarded, and which goes some way to solve the difficulty Padarn, for some reason, probably with an ulterior intention of settling in Brittany, did leave Wales. But we find a considerable district on the Cornish side of the Tamar, surrounded on all sides by Cornwall, yet belonging to Devon. This is the district of Petherwin. It consists of two parishes, both with churches under the patronage of S Padarn. These are the parishes of North and South Petherwin. The Life of the saint says he went to Guenet. Is it not possible that the writer of the Latin Life found that his hero, harassed by King Arthur and by Maelgwn, left Wales and betook himself to a Gwyned in Cornwall, now called Petherwin or Padarn's Gwyned. The author of the Life was able easily to make this Gwyned one with the Venedeta, where Paternus had been bishop in 465.

It is not advisable to altogether sweep away Caradog Freichfras, as does M de la Boderie, as having nothing to do with Padarn. It is possible enough that Caradog may have induced Padarn to join him in a raid on Brittany; but if one were undertaken, it came to nothing. It is more probable that Caradog had some possessions in West Wales, and induced Padarn to settle on them. And we know that Samson landed at Padstow, and founded a church at Southill. On the way he must have passed by Petherwin, and the story of the abbot-bishop running out to meet his cousin half shod is too naive to have been invented by a mediæval monk. It is probably true, and the scene of the incident would be Petherwin, and the occasion this visit.

In later times, when the Celtic monasteries languished, then this ecclesiastical *plou* of Petherwin was given to the abbey of Tavistock, and was united to the county of Devon.

The district over which Padarn held rule was elevated and wind-swept, whence perhaps its name, from Gwyned or Gwyntog. North Petherwin is now in Devon, but South Petherwin in

Cornwall. The district was originally more extensive, if we may judge by the possessions of the abbey of Tavistock around.

There is really no evidence that the Padarn of Wales ever did visit Brittany.

THE DYFRWYR Although these seven saints have no day specially devoted to them in the Welsh kalendars, it is deemed advisable to here insert them, as there are churches dedicated to them in Wales, wherein they must have been commemorated annually. The authority for their legend is the *Liber Lapidæus*, ed W J. Rees (Llandoverly, 1840), text, pp 120-2; translation, pp 367-9; or "The Book of Llan Dâv," from a twelfth-century MS, ed. Evans and Rhys (Oxford, 1893), pp 127-9.

There was a man named Cynwayw, of Dungleddy, in Pembrokeshire, of noble family, but poor, and his wife was so prolific that she gave him a son every year in succession. However, this rapid succession came to an abrupt termination, and seven years elapsed without Cynwayw having more children, and he confidently hoped that his anxieties were at an end, when his wife was delivered of seven at a birth, thus at one stroke making up leeway. The unhappy father became desperate, and he resolved to drown them like kittens.

"As by chance S Teilo was passing on his way, he found their father at Rysinetic, on the river Tâf, by the instigation of the devil plunging his sons one by one in the river, on account of his indigence and poverty. S. Teilo, beholding such cruel work, received them all half alive, and, with the giving of thanks, he baptized them in the name of the Father, Son, and Holy Ghost. Having taken away the seven sons from the unfortunate father, the very pious man brought them up, sent them to study literature, and placed them on his estate of Llandeilo (now called Llanddowror, in Carmarthenshire), so that the place received from some persons the name of Llandyfwyr, because, on account of their religious life, they had no other food than aquatic fishes, which, according to their number, seven, were sent by God to them daily, on a certain stone on the river Tâf, called in consequence Llech Meneich, that is, *The Monk's Stone*; and, again, they were called Dyfrwyr, because they were found in the water, escaped from the water, and were maintained by the fishes of the water, Dyfrwyr signifying, in the British tongue, *Men of the Water*.

"At a certain time S. Teilo, who had frequently visited them along with his disciples, came that he might enjoy their conversation, and one of the brothers, according to their custom,

went to the water for the fishes, and found on the aforesaid stone seven, according to the number of the brothers, and also an eighth, of larger size than the seven, all of which he brought home. And the brothers were thereat amazed, as it is said, 'The Lord is wonderful among His saints,' because they well knew that on account of their patron and master, S Teilo, becoming their guest, the Creator of all things had increased the number of the fishes.

"And after they had resided there a long time, living religiously, and passed much of their time in the society of S. Dubricius, he sent them to another place of his in Pebidiog (now the rural deanery in which is the city of S David's), called Mathru, and there they were named 'The Seven Saints of Mathru.' And after they remained there for another space of time, they came to Cenarth Mawr, where they continued until the end of their lives."

The story is introduced into the Book of Llandaff to account for the see of S. Teilo possessing lands in Pembrokeshire and Carmarthenshire and in the diocese of S David's

The memory of these seven brethren is attached to three churches—those of Llanddowror and Cenarth, in Carmarthenshire, and Mathru, in Pembrokeshire. These are now said to be dedicated to S. Teilo, S Llawdog, and the Holy Martyrs respectively. It is not difficult to perceive that in the legend is an element of truth. That the seven brethren were born at a birth is, of course, a mythical embellishment, taken from a tale very common in Celtic lands.

CYNDDILIG, the son of Nwython or Noethan, of the family of Caw, lord of Cwm Cawlwyd, in the north.

DONA, son of Selyf ab Cynan Garwyn, founded a church in Anglesey.

GWRYD is said to have been a friar, but nothing is known of him or his date.

- 2 ERC, *B. Slane, Ireland*, A.D. 513 (L.).
- 3 CRISTIOLUS, *C. Wales*, 7th cent.
 CLYDOG OR CLEATHER, *K.M. Cornwall and Herefordshire*, 6th cent. (see August 19).
 GWENAEL, *Ab. Landevenec, Britany*, A.D. 570 (L.).
Translation of S. WINIFRED, V.M. Flintshire, 7th cent. (L.).

RUMWALD, *C Brockley, circa A. D. 650 (see August 28)*

ENGLAT, *H. Tarves, in Scotland, 10th cent (L).*

MALACHY, *Abp. Armagh, A. D. 1148 (L.)*

CIYDOG is given on this day in the Calendar, "Iolo MSS," p 152

CRISTIOLUS, brother of S Sulien (September 1) and cousin of S Cadfan, was founder of churches in Pembrokeshire and Anglesey He belongs to the seventh century

4 DYFRIG OF DUBRICIUS, *his death (see May 29)*

BIRSTAN OF BRISTAN, *B. Winchester, A. D. 934*

BIRSTAN, or BRISTAN, or BRINSTAN, was consecrated by S Frithestan in 932 to succeed him as Bishop of Winchester It was his daily custom to celebrate a mass for the souls of the dead, and at night to visit the cemeteries, and there recite psalms on their behalf. On one occasion, so says the tale, the dead responded Amen from their graves He also daily fed a number of poor persons, whom he himself served at table. One day as he did not appear, his door was opened by his attendant, and he was found dead on his floor. No one seems to have at the time entertained the smallest notion that he was a saint, and it was not till Ethelwold, fifty years after, dreamed that he saw him in radiance, and that Birstan complained that his sanctity had been ignored, that his body was translated, and doubtless the details of his virtues excogitated to explain why he was to be esteemed a saint He died about 934.

5 KEA, *B. C. Cornwall and Brittany, early 6th cent.*

GWENFAEN, *V Anglesey, early 6th cent*

CYBI, *B Anglesey and Cornwall, 6th cent. (see November 8)*

KENAN, *B. Wales, Brittany, Ireland, 6th cent (L).*

KEA, KAY, or KENAN, was born of noble parents The Breton legend calls them Ludum and Tagu, and says they lived in Britain, and he became a monk in Wales One night in dream he heard a voice bid him take a bell and go with it till he reached a place named Rosynys, where it would sound of

itself, and there he was to settle. He accordingly procured a bell—it is said from Gildas—and he started on his travels.

There is a church and parish in Devon now called Landkey, but which must have been Llankea. Probably he rested for a while there, but it was not to be his continuous abode. When a passion set in for effacing by all means the memory of the Celtic saints and reducing all dedications to the dead uniformity of the Roman Kalendar, Landkey was re-dedicated to S Paul. Kea went on his way and crossed the Tamar. At last he was so fatigued that he cast himself on the grass, unable to proceed farther, near a beautiful creek, that was called Hirdraeth or the Long Estuary. He had, in fact, reached the mouth of the Fal, in Cornwall. As he lay in the grass, he heard a man standing by the water's edge calling to a fellow on the opposite bank, to know if he had seen his cows which had strayed. "Yes," shouted the other, "I saw them yesterday at Rosynys (now Roseland)." When Kea heard this, his weariness left him, and he went to the water's edge, which in Welsh, says the Life, is called Krestenn-Kea, or the Shore of S Kea. The writer probably mistook the word, which would be Traeth-Kea. There he struck a rock and produced a spring. He crossed the estuary and entered the wood that grew to the water's edge, and there built an oratory, as his bell at once began to tinkle. Near this the tyrant Tewdric, known as the slayer of SS Fingar and Piala, had his *lys* or court, which the biographer calls Gudrun¹. He carried off seven oxen and a cow that belonged to S Kea. Next day seven stags presented themselves to the saint, who yoked them and employed them to plough his land. On another occasion Tewdric struck Kea in the face, and cut his lip and knocked out some teeth. The saint without a word went to bathe his wounded mouth in a spring hard by, that was afterwards held to be efficacious in cases of toothache. At last Tewdric's persecution became so intolerable that Kea resolved to leave for Armorica. He sought to obtain corn for the journey from a merchant, but was refused, unless the monks could carry away with them a laden barge at the wharf at Landegu (Landege was the old name of S Kea). Kea and his companions at once threw a rope from their boat to the barge and drew it after them down the Fal and across the sea to the coast of Brittany. The place where Kea had established himself on the Fal was undoubtedly old Kea, where the tower of the church and a shaft of a cross remain. The new parish church is three miles distant.

¹ It is now called Goodern

Kea landed near Cleder, in Léon, and there he erected a monastery. He did not, however, remain there long, but returned to Britain, at the time when King Arthur was fighting the Saxons and his rebellious nephew Mordred. After the death of Arthur, Kea visited Gwenwer, and reproached her for her evil life, and exhorted her to enter into a monastery, repent, and dedicate the rest of her life to God. Then he went back to Cleder, in Brittany, to receive the last sigh of a S. Kerian (not Kieran of Saigr), who had long been his friend and fellow. There also he died and was buried. Several churches in Brittany honour him, a S. Quay near Lannion, S. Quay near S. Brieuc, but here, under Latin influence, the dedication has been altered to S. Caus, pope and martyr¹. At Cleder he is patron with S. Peter, who has apparently replaced S. Clether. Here a solemn mass is sung in his honour annually on the 2nd October. There is a Breton ballad narrating the life of the saint; as well as a Latin life.

GWENFAEN was the daughter of Pawl Hên, or Paulinus, and sister of S. Peulan. Nothing further is known of her.

6 MELANIUS, *B. Rennes*, A.D. 530

EFFLAM, *C. Brittany*, 6th cent.

EDWEN, *V. Anglesey*, 7th cent.

WINNOC, *Ab. Brittany and Flanders*, A.D. 717 (L.).

LEONARD OF RERESBY, *C. Thryberg, in Yorkshire*, 13th cent. (L.).

MELANIUS, Bishop of Rennes, was brought up at the court of the Breton duke, Hoel I, whose court was at Rennes. He persuaded several of the youths who were there with him to renounce the world and become monks. One day, so says the legend, he encountered a black bull in the forest, which was no other than the devil. The bull galloped to the monastery and ran at a monk who was drawing water at the well, and would have precipitated him down the well, had not Melanius arrived in time and beat the bull about the head. On the death of S. Amandus, in 511, Melanius was elected to succeed him in the see of Rennes, and he was present the same year at a council at Orleans. Rennes was a see distinct from those which were of British origin, and belonged to the Franco-Gallic Church.

¹ Under the title of Queman, he may also be the patron of a chapel at Tredrez, in S. Brieuc. *Mau is mock*, "my," a term of endearment

He was counsellor to Clovis, and was an active man in his diocese in bringing the people to nominal conformity to Christianity, for he found them to be real pagans. He did something among the Veneti to advance the Gospel, for they also were pagans. He died in 530. The churches of Mullion and S. Mellion, in Cornwall, are not dedicated to him. The Celtic Church was out of sympathy with Melanius, who was hand in glove with the Franks. They are actually foundations of S. Melyan, prince of Cornwall, the father of S. Melor, both were put to death by Rivold about A. D. 524.

EDWEN was, it is asserted, a female saint of Saxon descent, said to have been a daughter or niece of Edwin, King of Northumbria. In *Myvor Arch*, p. 424, we read of Edwin that he "was brought up in the court of Cadfan in Caersegaint," i. e. Segontium (Carnarvon). This will account for his sending a niece to a religious house in Wales. She is said to have founded Llanedwen, in Anglesey.

WINNOC. There were several of this name. Gwynnog, son of Gildas, is the Winnow of Cornwall.

EFFLAM. The legend of this saint is corrupt. Efflam is from the Welsh *efflan*, splendid, bright. The name in Irish is Felmh.

The legend bears on its face the character of its composition. Owing to the depredations of the Normans, the coast was deserted, and not only was the cell of the saint ruinous, but, as the writer of the legend admits, his memory was almost lost. The words are significant: "Hic longo tempore pretiosum corpus requevit absconditum in corpore terræ; cursu tempore labente, pene memona ejus de terris ablata est." At the close of the tenth century a solitary occupied the ruined habitation, and was led to suppose that some saint lay under the soil. He communicated with the Bishop of Treguer, and in 994 the body was sought for and found, and translated to the church of Llanefflam from the original cell, which was at Donguel or Dungwel, the position of which is not now known. The legend of the saint was then pieced together out of vague traditions; but it has come to us in a very late form, composed in the twelfth century. The Benedictine, Dom Denys Brent, one of Lobineau's assistants, judiciously said of it, "This extravagant legend . . . is a monument of the spirit of fable which reigned in the fourteenth century." He considers it later than do we, "when the romances of King Arthur and others of the same kind were the fashion."

Nevertheless there is certainly a substructure of truth in the tale. We will give the legend first, and then endeavour to extricate from it the core of fact.

There was once upon a time a King of Ireland who had a son named Efflam. According to a Breton ballad, by the way, the king was of Demetia, or South Wales. He was engaged in continuous warfare with another king—the legend says another Irish king, but that employed by Albert Legrand, from the Breviary of Plestin, says that he was a kinglet of Great Britain. At last it was settled to patch up the discord by marrying Efflam, the son of one, to Enora or Honoria, the daughter of the other. Exactly the same incident was introduced into the latest form of the legend of S Maudez. The marriage took place, much to Efflam's disgust, who had made up his mind to be a monk. On returning for the night the young couple maintained an animated argument on the topic of celibacy, which the composer of the legend gives with great fulness. At last Honora, beaten in argument, but unconvinced, went to sleep. Whereupon Efflam slipped on his clothes and stole away to the shore, where a body of like-minded men were awaiting him with a ship. They entered the vessel and sailed away, and landed in the estuary of the little stream that forms the boundary between the departments of Côtes-du-Nord and Finistère. There he discovered an empty house, and he settled in it and constituted a monastery. The companions he had brought with him erected separate cells, and he and they laboured to construct a church.

In the meantime, Enora found herself deserted. She did not relish her situation, and she went to the sea-side, found a man living there in the little port, and persuaded him to sew her up in a cow-hide and throw her into the sea.

Winds and waves swept her away, and the tide eventually threw her up over the salmon weir of the stream near Ploujestun or Plestin, and with the retreat of the tide there she remained. The keeper of the weir, going in the morning to see what was his catch, found a great leathern object, which he thought at first was a sea-monster; but recovering from his alarm, he perceived it was a bag, and he hoped it might contain a treasure. So he conveyed it home to his cabin, where it burst, and out came the lovely Enora—"salmocnans," says the legend writer. Now the *tuern* or chief of the land, to whom the weir belonged, also desired to know what was the catch, and what were his prospects for dinner that day. He sent for the keeper, whose equivocation and embarrassment made him suspect something, and when he threatened the man, he confessed all. The chief at once mounted his horse and galloped to the cottage, very curious to see the lovely woman who had come into

his weir sewed up in a cow-hide, and as desirous of securing her for himself. She, however, perceiving him coming, ran with all her might, and he spurred his horse in pursuit. She reached the cell of Efflam just in time, and the chief, putting out his hand to the doorpost, had it paralysed, and it adhered to the post; nor was he able to disengage himself till released by Efflam.

Here we may pause to remark that the story of the girl in a cow-hide drifting at sea is like that of the fair Azenor, mother of S Budoc, who was committed to the waves in a barrel. But it is an importation from the legend of Ceridwen and Taliesin. Ceridwen, we learn, "wrapped Taliesin in a leathern bag, and cast him into the sea to the mercy of God." In the story of Taliesin, the bag was carried to the salmon weir of Elfin and left there, and Elfin opened the bag and found Taliesin.

The arrival of his wife did not particularly please Efflam, and in no way induced him to alter his resolution. He made for Enora a separate cell, and he instructed her in the way of life through the wall but never allowed her to see his face, and, whether she liked it or no, she was constrained to maintain a cenobitical life.

Now it must be told that Arthur was king in those days, and that a terrible dragon infested the land. The dragon was peculiarly crafty, and always walked backward when going to his cave, so as to delude visitors into thinking he was abroad. King Arthur fought with the dragon, but unsuccessfully. Then Efflam, at his request, caused a fountain to break out of the rock, at which he might quench his thirst. The fountain is still shown. When Arthur had failed abjectly, then Efflam tried what he could do, and with the sign of the cross completely routed the monster, who fell over a cliff, which he stained with his blood, and which is called the Red Rock to this day.

All this is an episode.

Now, it will be recalled that Efflam had taken possession of an old cabin. One day the original builder and possessor of this cabin appeared. His name was Jestyn, and a scene of mutual compliments ensued, in which each desired the other to have the cell. At last it was agreed that Efflam should keep the hut, but that the spot should bear the name of Jestyn, and it was called Plou-Jestyn or Plestyn thenceforth, and will be to the end of time.

After some days the craving came on Efflam to go elsewhere. Accordingly he departed for Cornouailles, where he made settle-

ments, and left such a memory of his holiness that he was there ever after honoured

I give the passage, because it is important "Post multum vero temporis, recedens inde ad Cornubiam, volens ibi manere, famulas Deo acquisivit, cum quibus basilicam constituit et stadio hujus vitæ ibi decurso, bivio perenni meruit donari. Ibi memoria ejus quotidie agitur, et solemnî letitiâ festum ejus celebratur."

Such is the legend composed out of dim traditions, and embroidered *ad libitum* by the author.

Now let us see what is the substratum of fact; at all events, what we may allow that he did gather from tradition

Efflam was the son of a princeling, not in Brittany, but somewhere else. That he should have come as a coloniser from Ireland is improbable. He came, as one of the many settlers did in the sixth century, from Britain, and probably from either Cornwall or South Wales. But there had preceded him another colonist, Jestyn, whom we can identify as the son of Geiant, brother of S. Solomon and of Cador, Duke of Cornwall. Jestyn had taken possession of the land, and had constituted a *plou*, or clan. He gave up a site to Efflam for his *lann*. Efflam had not taken his wife with him, but she arrived soon after in a coracle. The legend writer could not make heads or tails out of the story of the skin boat in which she voyaged, and so made her to be sewn up in a cow-hide. Finding no record of any children born to Efflam, he concluded that both lived a life of continence. Moreover, it scandalised the writer of the thirteenth century that an abbot should have his wife with him, and he accordingly explained the awkward fact as best he could. But it is precisely this fact of the saintly abbot having his wife with him that makes us recognise substantial truth in the tradition. Both this and the separate cells in which the monks lived are characteristic features of the period. It is true enough that some of the abbots kept women rigorously at a distance, but the evidence that Efflam was an abbot is not convincing. A colonist he was, and a founder of ecclesiastical colonies, of more than one *lann*, and not of a *plou*, but it by no means followed that as such he kept apart from his wife. At Plestin, where his statue is placed near the high altar, he is represented in royal garb, crowned, and trampling on the dragon; whereas S. Jestyn, on the other hand, is figured in sacerdotal garb. Efflam is not only patron of Plestin, but also of the hospital at Morlaix, and of a chapel at Toul-Efflam, or the Hole of Efflam, near Læu-de-Grève, where he routed the dragon. The day on which he is

commemorated at Plestin is 6th November. We do not know whether this be the day of translation of his relics or of his death.

It is perhaps needless to say that no trace of Efflam can be found in Irish or Welsh kalendars. He was also without cult in Lower Brittany.

In 1819 the curé of Plestin, when a mission was held there, hoped to stimulate the enthusiasm of his parishioners by an "elevation" of the relics of S. Efflam. He therefore opened the tomb, to which the remains had been translated in 994, but found underneath it only a slab of granite, with an axe cut on it, and saw particles of bone, mixed with earth and seaweed, and a little copper cross, much corroded. Apparently in 994 the Bishop of Treguer had opened a tumulus, in which was a kistvaen, and had come on a prehistoric interment by incineration. He had carried away the fragments of half-burnt bone, and the top slab of the monument, marked with a celt, and buried all in the church at Plestin, and put with them a little cross.

M. A. de la Borderie has published the legend of S. Efflam (Rennes, 1892), with critical remarks. A Breton ballad relative to him is given by De la Villemarqué, in his *Bars Breiz*, but all his productions have to be received with reserve, as he manipulated his texts very much as did some of the editors of Scottish ballads treat what they obtained orally. There is, however, a portion of a Breton ballad in a more trustworthy work, M. de Kerdanet's edition of Albert Le Grand's *Vies des Saints* (Brest, 1837).

7 CYNGAR OF CUNGAR, *Ab Somersetshire, Glamorganshire, and Anglesey, 6th cent.*

ILLTYD, *Ab Llantwit, 6th cent. (see July 7).*

CYNGAR OF CUNGAR was a son of Gerant, Prince of Devon. He was at first in Somersetshire, where he founded churches at Badgworth and Congresbury. After that Somerset was overrun by the West Saxons, he retreated into Wales and founded the monastery of Llangeny, in the diocese of Llandaff. His date is about 540.

In Cornwall a chapel and holy well in the parish of Lanlivet bear his name. Not only so, but his name has gone through curious transformation. He is also called Docwin, and as such appears as founder of S. Kew, which in Bishop Stafford's and other registers appears as the church of S. Dogunus. The

church was originally called Landoc This was softened to Landoue, then the *Lan* was cut off with the *d*, and it became S Oue, for euphony S Kewe

There was another S Cyngar ab Arthog ab Ceredig, and another Docwinus is given by Capgrave

- 8 CYBI OR CUBY, *B Anglesey and Cornwall (L.)*; also *May 6.*

TYSSILIO, *Ab Wales, middle of 7th cent (L.)*.

CYNFARWY, *C. Anglesey, 7th cent.*

CYNFARWY was the son of Awy ab Lleenawg, Prince of Cornwall He founded a church in Anglesey.

- 9 PABO POST PRYDAIN, *C. Anglesey, circa A.D 510*

PABO POST PRYDAIN—that is to say, the Prop or Pillar of North Britain—descended from Coel Godebog or “the Incontinent,” was a brave soldier. In the Welsh accounts Coel is termed Earl of Gloucester, he is also said to have been a king in North Britain We know that there were contests with Saxon or Angle invaders in the valley of the Tweed, before Ida, “the Flame Bearer,” founded the kingdom of Bernicia, but we may suspect that Coel and Pabo fought rather against the Picts, and that first Coel abandoned the struggle, and then his son.

Pabo, losing heart, despairing of holding his own, retreated to Wales, where he was hospitably received by Cyngen, Prince of Powys, who, in conjunction with his son Brocwel Ysgythrog, gave him a piece of land in Anglesey where he might settle as a saint He married S. Gwenaseth, daughter of Rhufon Rhufonog.

The church of Llanbabo, if not that erected by him, has been reconstructed out of material used by him for his original church. His inscribed stone was dug up in the reign of Charles II; but it was not original, it was carved in the reign of Edward III. It is visible in the church. His son Dunawd is also numbered among the saints. There was a tradition in Llanbabo that Pabo with his son and daughter were buried in the churchyard opposite certain faces carved on the wall These faces are still to be seen immediately above the door, but the exact position of the grave cannot be determined The date of Pabo's death is perhaps 510 Professor Rhys, in his “*Arthurian Legend*,” is inclined to identify him with the Palamydes of Sir Thomas Malory.



TOMB OF S. PABO AT LLANBAGO.

- 10 ELAETH FRENHIN OF THE KING, *C. Anglesey, 6th cent*
JUSTUS, *Abp. Canterbury, A D 627*

ELAETH THE KING was son of Meurig, of the tribe of Coel Godebog, to which Pabo and Dunawd belonged. He was a chief in the North, but was driven South by the Picts, and spent his declining years in the monastery of S Seiriol at Penmon, in Anglesey. He was a bard, and two religious poems by him are contained in the Black Book of Carmarthen. He belonged to the middle of the sixth century.

JUSTUS was one of those sent by Gregory the Great at the request of S Augustine to assist him in his labours among the English. He had been a monk of S. Andrew's on the Coelian Hill. After Justus had been three years in Kent, Augustine consecrated him to be first Bishop of Rochester, a see that King Ethelbert had endowed, and the church was dedicated to S. Andrew, in memory of that place in Rome whence the English mission had started. When Augustine and Ethelbert were dead, there ensued a great pagan reaction, and both Justus and Mellitus, Bishop of London, fled to the Continent. Before long, however, the conversion of King Eadbald made way for their return, and Justus resumed the government of his church, which he retained till the death of Mellitus, when he was chosen archbishop. He had the happiness to be able to send S. Paulinus in company with Queen Ethelburga into Northumbria, and so prepare the way for its conversion. He died in 627.

- 11 CYNFRAN, *C Carnarvonshire, 5th cent.*
EDEYRN, *C Anglesey, 6th cent. (see January 6)*
RHEDIW, *C Carnarvonshire, date unknown.*
RICTRYTH, *W Abbs. Northumbria, A D. 786.*

CYNFRAN was one of the sons of Brychan, and the founder of the church of Llysfaen, in Carnarvonshire, where it was usual to invoke "the grace of God and the blessed Cynfran on the cattle," when offerings were made at S Cynfran's Well. His brother Cynbryd is patron of the adjoining parish, Llanddulas.

RHEDIW was a saint whose date is unknown. He was buried at Llanllyfnu, in Carnarvonshire, the church of which is dedicated to him. Formerly there were shown there his well, his seat, the print of his horse's hoof, and the mark of his thumb on a stone.

- 12 CUMMIAN FADA, *Ab. Kilconn, Ireland, 6th cent (L).*
CADWALADR, *K C. Wales, A D 664 (see October 8)*
- 13 COLUMBA, *V.M. Cornwall, date unknown (L).*
MOCHAR or MOCHUMNA, *B Scotland, end of 6th cent.*
(L).
DEVINIC or DEWEDNAC, *B Scotland, end of 6th cent.*
(L).
GREDIFAEL, *C. Anglesey, 6th cent*

GREDIFAEL was the son of Ithel Hael, a prince of Armorica, whose family came over to Wales in the great migration under S Cadfan and S Padarn, in four companies, whereof one only, that of S. Padarn, numbered 847 monks—if we may trust his biographer. He and his brother Fflewyn were appointed to preside over the monastery of Pawl Hên at Tygwyn ar Dâf, or Whitland, in Carmarthenshire.

- 14 DUBRICIUS or DYFRIG, *B. Caerleon, Monmouthshire,*
circa A D 524 (L).
MODAN, *B Scotland, date not known*
Translation of S. ERKONWALD, B. (see April 30)
LAURENCE O'TOOLE, *Abp. Dublin, A D 1180 (L).*

DUBRICIUS is given on this day in a twelfth-century calendar of Welsh saints in the British Museum, and by Father Staunton in his "Menology of England," 1887.

- 15 MALO or MACLOVIUS, *B. Wales and Brittany, A.D.*
627 (L).
MECHELL or MACHUDD, *C. Anglesey, 7th cent*
CYNFAB, *C. Carmarthenshire, 7th cent.*

MALO A summary of the Life by Bilh is given by Leland, *Collect.* ii 430. The Life has been published in the Bulletin of the Société Archæologique d'Ille-et-Vilaine, xvi. So also the Vita II^a. At Godmanchester, in Huntingdonshire, it was

claimed that S Malo had been bishop there, and son of the local Count."—Leland, *Collect.* iv 14.

MECHELL or MACHUDD was the son of Echwydd, and the founder of the church of Llanfechell, in Anglesey, where there was at one time a college of a hundred saints.

CYNFAB founded Capel Cynfab, a chapel once existing in the parish of Llanfairarybryn, in Carmarthenshire.

16 AFAN, *C. Brecknockshire and Cardiganshire, early 6th cent*

ALFRIC, *Abp. Canterbury*, A D 1006.

MARGARET, *Q W. Scotland*, A D. 1093; see June 10 (L).

EDMUND RICH, *Abp. Canterbury*, A D 1242 (L).

AFAN, commonly called Afan Buallt (of Bulth), was of the family of Cunedda. He was buried at Llanafan, in Brecknockshire, where his tomb still remains with an inscription. He is thought to have been third bishop of Llanbadarn, a diocese afterwards absorbed into that of S. David's. His name is inserted on this day in the "Greal" and the "Cambrian Register Kalendars," and by Rees. But the kalendar in the "Iolo MSS" gives November 17. His inscribed tombstone entitles him bishop, but it is of late date.

ALFRIC, Abbot of Abingdon, was created Bishop of Wilton, and on the death of Sithric he became Archbishop of Canterbury. He died in 1006.

17 HILDA, *V. Abs. Whitby*, A.D. 679 (L.)

FERGUS, *B Glamis, Scotland, 8th cent.*; also on November 18.

HUGH, *B. Lincoln*, A.D. 1200 (L.).

18 WYNNEN, *B Scotland*, A.D. 579, same as S. FINIAN of *Mouille, September 10.*

KEVERN, *C. Cornwall, 6th cent.*

MAWES or MAUDEZ, *Ab. Cornwall and Brittany, 6th cent.*

KEVERN is said to have been a saint in Cornwall of the same date as S. Piran or Kieran, and to have been his friend. As a

matter of fact, Kevern is Kieran himself. Of this there can be no doubt, for in the Registers of Bishop Stafford the dedication to Kieran is given for this parish.

A local tradition is perhaps worth telling. S. Just, a saintly friend, went to visit S. Kevern, when he fell to coveting a piece of plate, perhaps a chalice, belonging to his host. Just considered how he might secure it. Bidding Kevern go fetch him water from his well, he took advantage of his absence to make off with the article in question. But S. Kevern, on finding, when he returned with the water, that his friend had decamped, suspected mischief, and soon saw that Just was the thief. He pursued him, and picking up, as he went, three stones of a peculiar sort found on Coruza Downs, he overtook him at a spot where Germo Lane joins the Helston Road. There he set to work to pelt him with the stones, and so forced him to abandon his ill-gotten goods. The place was ever after called Tre-men-Keverne, the Three Stones of Kevern. Of late years these stones have been broken up to mend the roads with them. Kevern belongs to the sixth century.

MAWES or MAUDEZ The two Lives of this saint, as well as the hymns for his festival, and the lessons from the several breviaries, have been printed and subjected to criticism by M. de la Boderie ("Saint Maudez," Rennes, 1891). The first Life was written towards the end of the eleventh century. The second Life is a very unsatisfactory production; it is hardly earlier than the thirteenth century. The first was employed in its composition, and the gaps left by the writer of the first were filled in with fanciful tales by the composer of the second.

S. Maudez was the son of a kinglet in Ireland called Erclaus, and his mother's name was Gentusa. As the tenth son of the royal couple he was dedicated to God. After his education was completed he left Ireland. This is all that the author of the first Life knew. The composer of the second was not satisfied, so he added this. A pestilence raged in Ireland and swept off King Erclaus and his nine children. Then a pretender laid his hand on the crown. The nobles thereupon sought out Maudez, who was abbot of his monastery, and insisted not only on his assuming the kingly dignity, but also on his marrying the daughter of the pretender. Maudez asked for a night and day to consider the proposal, and he prayed to God to deliver him, whereupon he became covered with the most disgusting sores—at sight of which the nobles declined to favour his elevation, and the damsel absolutely refused to receive him as a husband.

The author of the first Life clearly knew no more of the early

life of Maudez than what he related—in a word, knew little more of him than his actions when in Brittany. There he arrived with two disciples, Tudy and Bodmael, and he settled in an islet of the Bréhat archipelago, on the north coast of Domnonia, and there he died after having founded a monastery.

But that he took Cornwall on the way is rendered almost certain by the fact that both he and Tudy have left their names there as founders. And this Cornish visit was apparently preceded by one to Wales, for Tudy is known there as Tegwyn (*see September 14*), the son of Ithel Hael. In Cornwall, Maudez is supposed to have come from Wales, and to have been driven thence by the Saxons, and to have established himself on a rock in Roseland by the mouth of the Fal, where he miraculously produced a fountain, and where he also carved for himself a chair in stone. The district, one of *rhos* or moor, was treeless, and thence the name given to Roseland or Llanau Rhos, the Churches of the Heath, the region comprising four parishes. The ancient chapel of S. Mawes was existing till 1812, when it was pulled down and a new church erected on its site. The well of S. Mawes is still in use; and incorporated with some stonework at the foot of a house hard by, is one side of his reputed chair.

From this chair, according to the *Life*, Mawes instructed his disciples Tudy and Bodmael, and others who are not named. When they were not listening to his teaching or praying, they were wont to assemble by the chair near the water, and go over the instruction they had received, so as to engrave it deep on their memories. They were, however, much disturbed by a great seal that came up and stared at them, gamboled, and made noises. And this came to the ears of Mawes.

One day he was on his way to the chair, from his cell, when he saw the seal, and immediately rushed at it, armed with a stone. The brute took to the water at once, but when it rose, Mawes hurled at it the stone, struck it, and it sank. The spot where it rose was on a rock that stood up out of the water, now called Blackrocks, and the stone he threw remained lodged on the top. It was a notable cast, for the spot is nearer Pendennis Point than S. Mawes' cell. This poor seal the saint was convinced was an evil spirit—"a Tuthe," as the author of the *Life* says the Britons called it. In Breton this would be Tuz, and we may find in the word the "Deuce," so commonly used in the West of England as expressing a spirit of mischief and contrariety. In fact, one of those genii of whom S. Augustine says, "*Dæmones quos Dussios Galli nuncupant.*"

According to Cornish tradition, after a while Mawes left

Cornwall and crossed over to Brittany, and we learn from his biographer that he arrived in the island that has since borne his name in the Bréhat archipelago. Here he founded a monastery. One day the fire had gone out, and Mawes sent his disciple Bodmael across the mainland when the tide was low to fetch him some. Bodmael entered a cottage, when a woman consented to give him red-hot coals if he would carry them in his lap. To this he consented, but as he was returning with the fire the tide rose, and Mawes, to his dismay, saw that his pupil would be engulfed. However, he prayed, and a rock rose under the disciple, and as the tide lifted so did the rock, and when the tide had ebbed, Bodmael came to the island unharmed, and the fire unextinguished. If there be any basis of truth in the story, then it may belong to the period in Cornwall, just as well as to that in Brittany. I am not sure that it would be possible for a man to cross to Lanmodey on the coast, and back, except in a boat; but it would be quite possible to send any one across the creek of Porthcuel River to S Anthony in Roseland.

The name of Maudez or Mawes is by no means unknown in Ireland. He is there called Modteus; but neither Ussher nor Lanigan were acquainted with the acts of S Maudez, in the Life, Maudetus, and so were unable to identify him. Unhappily, we have no Irish account which can enable us to ascertain from what family he issued. The Life was probably composed by a monk of P'île Modez, and he has transferred to it the incidents of the quest of fire and the seal. There is an old thorn-tree on the island which goes by the name of the Chaire de S. Modez.

19 LLWYDIAN, *C Anglesey, end of 7th cent.*

BUDOC, *B. Dol, end of 6th century; see December 9 (L.).*

MEDANA, *V. Westmeath and Scotland.*

ERMENBURGA OR DOMNEVA, *Abss Thanet, circa 690.*

EGBERT, *Abp. York, A.D. 766*

MEDANA, according to the lesson in the Aberdeen Breviary, was an Irish virgin who, fleeing from the advances of a soldier, came on a vessel, with two handmaids, to Scotland. Being still pursued, she got on a stone, with her maids, and floated thirty miles to a place called Farnes. The soldier still pursuing her, she climbed up a tree and pulled out her eyes. After that her attractions failed to excite the soldier, and he let her descend the tree

unmolested She died on the 31st October, but her festival was observed on 19th November She seems to be the same as S. Midhnat, virgin, of Killucan, in Westmeath, commemorated in Irish kalendars on 18th November. Her chapel is a natural cave, to which masonry has been added.

ERMENBURGA or DOMNEVA, daughter of Ermenred, King of Kent, was given in marriage to Merewald, son of Penda She and her pious husband devoted themselves to the spread of religion in Mercia. They were the parents of S Milburga, S. Mildred, and S Mildgytha, and their son Merefin was "led away to heaven in his youth." Ermenburga was called into Kent to settle the "blood-geld," or fine to be paid for the murder of her brothers Ethelred and Ethelbert, who were killed by Egbert, King of Kent, at the instigation of his chief eorlder-man, Thanor. The murder was committed at Eastry. The facts becoming known, he was called upon to pay the blood-fine to the nearest of kin, and Ermenburga accordingly went to Kent to demand it. She claimed as much land as her tame deer could run round in a single course. The hind enclosed an area of ten thousand acres Within this the monastery of Minster-in-Thamet was erected, and there Ermenburga assumed the name of Domneva or Domina Ebba, and became first abbess She died about 690.

EGBERT was the son of Eata, and was raised to be Bishop of York during the reign of Ceolwulf, King of Northumbria The princes of the northern kingdom were very desirous of disengaging the see of York from the control of Canterbury, in the southern kingdom. Bede himself saw the advantage of this, and drew up a scheme of religious reformation, one of the principal features of which was the revival of the archbishopric which Pope Gregory had originally designed to set up in the north; and this suggestion was soon realised, for Egbert procured from Rome his recognition as archbishop in 735 Egbert had founded in his cathedral city the celebrated school, of which Alcuin was the most distinguished pupil Bede was his intimate friend, and to him he wrote his last letter on ecclesiastical discipline In his Metrical History of the Bishops of York, Alcuin speaks in high terms of the holy life and zeal for God's service that were manifest in Egbert In 738 Edbert, brother of Egbert, became King of Northumbria, and king and prelate worked most harmoniously together.

The whole of the northern quarter and much of the eastern quarter of the city of York had been given up to the Church by Edwin, and in the midst of this the king had reared a little

wooden chapel for Paulinus, and had begun a larger church in stone. But his fall stopped the progress of this building, and Wilfrid in 670 found the church almost in ruins, the windows covered with mere trellis-work, and the roof rotted with the rain. Wilfrid energetically undertook to rear a cathedral that should rival the buildings of Hexham and Ripon, and its enlargement and decoration were actively carried on by Egbert.

The king, Edbert, resigned the crown in 758, in discouragement at a crushing disaster he had encountered at the hands of the Britons of Strathclyde two years before. He retired into a monastery, and the archbishop joined him. Egbert died in 766, and was laid beside his brother in York Minster.

20 *EWAL, B.C. Cornwall, 6th cent.*

CELYNIN, C. Carnarvon and Meroneth, 7th cent.

EDMUND, K.M. Hoxne, Suffolk, A.D. 870 (L.).

EWAL, or *EWALL*, or *UVELLUS*, is probably Ufelwyn, son of Cennydd, and grandson of Gildas; he was brother of S. Filius of Phileigh. He is believed to have been one of the British bishops who met Augustine in the celebrated conference relative to the mission to the Saxons. He is known in Brittany as Uvol or Urfol. His feast day at S. Ewal is on November 20, at Wythiel, also dedicated to him on November 23.

CELYNIN was one of the sons of Helig, whose territory was inundated, and whose sons became members of the colleges of Bangor in Arfon, and Anglesey. He is not to be confounded with a namesake, one of the sons of Cynyr Farfdrwch, who lived a century earlier.

EDMUND. According to the local legend the king had concealed himself under a bridge, and was discovered by the reflection of his golden spurs in the water. The bridge is to this day called Gilt-spur Bridge.

The tree against which S. Edmund stood when shot at was a mighty old oak, indicated by tradition. A few years ago the tree was blown down. On its being cut up it was found to contain a number of arrow-heads embedded in the wood. At Brome Hall, near the site, a block of the oak is preserved, with the arrow-heads still in it.

21 *DIGAIN, C. Denbighshire, 5th cent.*

COLUMBANUS, Ab. Bobbio, A.D. 615 (L.).

DIGAIN was brother of Erbin and son of Constantine, King

of Cornwall. He founded a church in Denbighshire, Llangernyw, or the "Church of the Coinshman." Erbin is S. Ervan in Cornwall, but Digain has left no trace of himself in Cornwall.

22

23 PAULINUS or PAWL HËN, *Ab. B. Carmarthenshire, late 5th cent.*

DEINIOL THE YOUNGER or DEINIOLEN, *Ab. Bangor, Carnarvonshire, CIRCA A.D. 620*

PAULINUS or PEULIN; in Welsh, PAWL HËN, or the Aged. In the Cambrian Register he is entered as Polin, bishop. The epithet of "O Fanaw" applied to him would indicate that he was a native of the Isle of Man. He came to Caerworgon, where he became a disciple of S Illtyd, and then moved south, and founded a monastery in 480 at Tygwyn ar Dâf, or the White Habitation on the Teify. It became known after the Norman Conquest as Whitland, in Carmarthen, and is now represented by a few crumbling walls in the midst of a district devoted to tinplating, and bristling with chimneys. He was first abbot of his monastery and in episcopal orders. From his fame as a teacher, many saints came to study under him; and he had the moulding of both S David and S Teilo. In the Life of S David it is said that Paulinus had lost his eyesight through inflammation setting in. Then he said to David, "Look into my eyes, for they pain me." "Lord Master," answered he, "do not order me to look at thy eyes; for the ten years since I came to thee to be instructed, I have not looked into thy face." This is supposed to have been an eminent token of humility on the part of David. However, the disciple ventured to put his hands on the eyes of the old abbot, and from that moment the inflammation abated, and in a few days Paulinus was able to see again, and attributed his recovery to the merits of David—or the biographers supposed that he did.

If there be any foundation at all for the story, it is this, that Paulinus had sore eyes through something getting into them, which David was able to remove.

Then an angel bade Paulinus send away David to finish his education at Glastonbury, and this he did.

Paulinus attended the council of Llanddewi Brefi, which took place before 569, say Haddan and Stubbs; the date usually given it is 519. There were present a hundred and eighteen bishops, if we may trust the second Life of S David, besides numerous chiefs and priests, laymen and women. Why Llanddewi Brefi was chosen is not clear. There was a large swamp occupying the junction of the Afon and Teify. Probably the place—where stood the ancient *Loventium*, a Roman city—was not wholly desolate, and there may have been a church there, afterwards removed to Llanddewi. Moreover, *Loventium* was on the great paved way *Sarn Helen*. But the place—so runs the tale—was not found suitable, the bishops made a great heap of garments, and the speakers who addressed the assembly stood on top of this, but the expedient was unsatisfactory. “They endeavoured to preach from the top of this raised heap of clothes, but, as if from an obstructed throat, the discourse scarcely reached those nearest.” Then Paulinus remarked to his fellows that he did not see his old pupil, David, who ought to be there, and, at his advice, Demol and Dyfrig or Dubricius went to *Menevia* to fetch him.

No sooner had David arrived, than with clear common-sense he saw that the assembly was gathered in an unsuitable spot, and at his advice it moved away from the ruined city of *Loventium*, to where was an old tump, a mound formerly fortified, such as are common throughout South Wales, from the top of which it was easy to address a great crowd. This is the probable explanation of the fable told in his Life, that a mound rose up under the feet of David, and dispensed with the need for the heap of old clothes. Moreover, if this explanation be right, we see that the synod was appointed to meet at *Loventium*, but that for the sake of the moated tump, was shifted a little way off to where now stands *Llanddewi Brefi*, that has given its name to the synod.

We hear no more of S Paulinus. He lived to a great age, and retired from his monastery to *Caio*—perhaps he retired there immediately after the council, along *Sarn Helen*—and there he died. His inscribed stone was found at *Pant-y-Pohon*, that is, the Dip in the Land of Paulinus, and it bears the following inscription —

Servatur fidæ
Patrieq· semper
Amator hic Paulin
us jacet cultor pient
simus æqui

A guardian of the faith, a true lover of his country, and holy minister of God's word to the people—that is what Paulmus was, on the testimony of this stone. The monument is preserved in Dolaucothi House. He was the father of SS. Peulan, Gwyngeneu, and Gwenfaen.

DEINIOLEN, DEINIOLFAB, or DEINIOL THE YOUNGER, was son of S. Deiniol, Abbot and Bishop of Bangor, in Carnarvonshire. He was educated at Bangor-Iscoed, in Flintshire, under his grandfather Dunawd. After the destruction of the abbey in 613, he retired into his father's monastery, and succeeded to the abbacy. The account of the disaster which caused him to fly is told by Bede. Ethelfred fought the Britons, and made a great slaughter at Chester. "Being about to give battle, he observed their priests, who were come together to offer up their prayers to God for the soldiers, standing apart in a place of more safety. He inquired who they were, and why they had gathered there. Most of them were from the monastery of Bangor, in which, it is reported, there was so great a number of monks, that the monastery was divided into seven parts with a ruler over each, none of those parts containing less than three hundred men, who all lived by the labour of their hands. Many of these, after a fast of three days, placed themselves under the protection of one Brocmael, who undertook to defend them against the swords of the barbarians whilst they were engaged in prayer for his success. King Ethelfred (of Northumbria), on hearing why they had come, said, 'If they cry to their God against us, although not bearing arms, they are in truth our adversaries, fighting against us by their prayers.' He therefore commanded them to be attacked first, and then destroyed the rest of the impious army. About twelve hundred of those that came to pray are said to have been killed, and only fifty to have escaped by flight. Brocmael, instead of defending them, as he ought, at the first approach of the enemy, turned and fled, and left them exposed to the swords of their enemies."

The Anglo-Saxon chronicle makes the number slain to have been two hundred. Perhaps Bede inadvertently reckoned the entire loss of the British in that battle as one of monks who were massacred. The destruction of the monastery of Bangor-Iscoed followed immediately.

It is characteristic of theological rancour that even the gentle Bede exults over this horrible butchery as a judgment on the British Church for not accepting the self-assertive supremacy of Augustine. Deiniolen must have been either left behind in Bangor before the battle, or have been one of those who were so happy as to escape from it. He died about 621.

- 24 MINVER OR MENEFREDA, *V. Cornwall, 6th cent.; also July 13.*

MINVER OR MENEFREDA is a reputed daughter (actually granddaughter) of Brychan of Brecknock, in Domesday the parish of Minver, in Cornwall, is called Rosminvet. The Latin form of the name is Menefreda. This is a singular compound. The original saint was Mwynen, granddaughter of Brychan, and was perhaps known in Cornwall as Mwynfrw. Gwenfrewi became the Winefreda of the monastic scribes, and Mwynfrw would naturally be rendered in Latin, Menefrida.

Mwyn signifies mild, gentle, and courteous. Minver is probably a corruption of Mwyn-vawr, the Great Mwynen, in contradistinction to a chapel in the same parish which was Mwyn-vach, but which has disappeared.

Mwynen was the daughter of Brynach, the Irishman, who founded a church in North Devon, on his return to Wales from Brittany. Her brother Gerwyn or Berwyn founded a church in Cornwall, and this is probably the Merry of North Cornwall, and Berwyn of an old Cornish calendar, quoted by William of Worcester. It is noticeable that the church of S. Minver is near that of S. Enoder, which is, in fact, a chapelry in the parish, and Enoder is Cynydr, whose mother was a daughter of Brychan, consequently Enoder and Minver were cousins. There was quite a colony of relatives in the neighbourhood. Beside her uncle Merry, there were S. Teath, S. Maby, and, at Tintagel, S. Materiana.

- 25 CATHERINE AUDLEY, *R. Ledbury, circa A D 1400*

CATHERINE AUDLEY. According to the legend, there lived at Ledbury, at the close of the fourteenth century, a holy woman, whose name was Katharine Audley, and she was called S. Katharine. She came there with her maid Mabel, and she stayed there because it had been revealed to her that she was to dwell where she heard the bells ring of themselves, and she lived upon milk and herbs. Now she had a mare, and it came to pass that this mare with her colt was stolen, and the saint prayed that the thief might be found by the tracks of the mare's feet. But the thief, fearing the prayers of the saint, had led the mare along the course of the brook; yet it was so, that on the stones of the brook all the way were found the marks of the mare's feet and of the colt's, and also of the patters of the maid who

stole them ; and so this wicked deed was made known, and the saint recovered that which she had lost. The most distinctly marked of the stones used formerly to be collected as charms or safeguards against robbery, but less clear impressions are frequent in the main and smaller water-courses. On a fragment lately secured, however, the "colt's foot" is deeply and exactly defined, while near it as distinct a circular groove marks the "maid's patten," the nature and colouring of the stone showing plainly how the harder portions had resisted the action of the water. The story of S. Katharine's mare and colt was firmly believed in the district early in the present century ; and local antiquaries, in papers read before their societies forty or fifty years ago, while rejecting the element of miracle, yet referred the footprints to "antediluvian" animals, including, apparently, even the "patten"-wearing "maid," who, there is reason to fear, must have been the faithless domestic of the saint herself.

There would be nothing in this myth distinguishing it from any ordinary popular legend, but for the curiously precise historical element which appears to be mixed up with the mediæval miracle. The phenomenon of the seeming hoof-marks would inevitably have involved some story to account for them ; and S. Katharine was not only a saint generally held in honour in England, but also of special regard at Ledbury, where a chapel of S. Katharine still remains in the parish church, and where a S. Katharine's Hospital was founded in 1232 by Hugh Ffolliott, Bishop of Hereford, this survives under the government of the church of Hereford, and has never been perverted into a sinecure or an abuse. It would thus have been very natural that the miracle of the Sapey and other brooks should have been ascribed to S. Katharine V.M. ; but the place of this well-known saint has been strangely usurped in the existing form of the legend by an indigenous Katharine with the non-ecclesiastical surname of Audley, to whom, according to the local guide-book, "the king, in consideration of her birth, or piety, or both, granted an annuity of £30." At the Dissolution the revenues of the Hospital of S. Katharine of Ledbury were returned at £32, 7s 11d annually ; and an "annuity of £30" in the reign of Edward II would have provided a "religious woman and her maid," we may be sure, with much better fare than "herbs and milk." From this odd detail in the story the clue to the perplexity is obtained. The Close Rolls of 16, 17, and 18 Edward II. in the Public Record Office exhibit the grant of this large annuity to "Katharine de Audele," expressly described as "Recluse of Ledebury," and designated in both

documents as "dilecta nobis in Christo" The Sheriff of Hereford is ordered to take into the king's hands certain specified lands in the county, and out of the revenues to pay the annuity, with arrears of £22, to the said Katharine, the remainder of the issues to be paid into the king's chamber. Subsequent orders to the same effect are addressed to John Wroth, Keeper of the Manors aforementioned. For what reason so munificent a grant was made by the king for the support of the "recluse" is not evident; but the lady had not always found her vocation in a religious life, and if the bells ever rang at Ledbury in her behalf, the occasion was anything but supernatural. The Close Roll of 7 Edward II. has a record setting forth how "Katharine de Audelere granted to James de Perreis and Ela his wife, her daughter, the castle and town of Thlanandeuery," &c, the grant being "dated at Ledbury." The lady, after having seen her daughter well settled, in every sense of the word, upon a Welsh estate, would seem to have adopted the profession of a "recluse" upon a very comfortable provision for her old age, and to have had little need to trouble herself about a casually missing cart-horse—unless, indeed, under this legend, too, may lie hidden some memory of armed marauders; for Ledbury, like Much Cowarne, lies on an obvious line of inroad from the Welsh border.

26

- 27 GALLGO OF GALLGOF, *C. Wales, 6th cent.*
VIRGILIUS, *B. Salzburg, A.D. 780 (L.).*

GALLGO was a son of Caw, and he founded the church of Llanallgo, in Anglesey.

- 28 PATRICIAN, *B. Sutherlandshire, 5th cent.*
SECUNDINUS, *B. Dunshaughlin, Meath, A.D. 458.*

PATRICIAN is said to have fled before the Saxons, being a bishop of the Romano-Britons, probably in Strathclyde, and taken refuge in Sodor or the Isle of Man, where he was given lands by King Congal. In Dempster's "Scottish Menology" he is given on the 10th October.

SECUNDINUS, AUXILIUS, and ISSERNINUS were bishops who came to assist S. Patrick in his labours in Ireland about 439.

Secundinus and Auxilius were his nephews sons of his sister Darerca, according to a late account. It is also very doubtful that they were bishops when they arrived in Ireland, unless they came from some Celtic monastery, where bishops were numerous. Moreover, according to other accounts they were consecrated by S. Patrick himself. About 443 S. Patrick left Secundinus in Meath, to build up his converts in the faith, whilst the apostle himself went on into Leinster and Munster. The suffraganship of Secundinus lasted about six years, and he died in 448. His usual place of residence was Dunshaughlin, but his was a roving commission, and there were then no territorial sees.

- 29 BARRWG, *H.C. Barry Isle, Glamorganshire, 5th cent.*
 SADWRN, *H.C. Anglesey and Carmarthenshire, early 6th cent.*

EGELWIN, *C. Athelney, Somersetshire, 7th cent*

BARRWG or BARRUC was a disciple of S. Cadoc. The abbot sailed with him one day to the island off the coast of Glamorganshire, that has since borne the name of Barry. Along with Barrwg was another, Gwalches. When Cadoc had landed he asked for his little prayer-book. The disciples confessed that they had forgotten it. In a fury he ordered them to re-embark and recover it, and then, his anger getting the better of him, he cursed them that they might never return. They went to where the book had been left, and brought it to the boat, and stepped in again, but on their way to the island were swamped and drowned, Cadoc looking on the while. The body of Barrwg was carried to the shore and was buried, but that of Gwalches was swept by the current to another islet. For what particular reason Barrwg was esteemed a saint does not transpire.

SADWRN FARCHOG or "the Knight" was a brother of S. Illtyd, and a disciple of S. Cadfan, whom he accompanied to Wales. He founded churches in Anglesey and Carmarthenshire. There is another Sadwrn mentioned in the second legend of S. Winefred, which is a very untrustworthy document, even more so than the first. But there is no allusion to him in either the first legend or in the Life of S. Beuno, and thus other Sadwrn is therefore probably mythical.

It is a mistake to identify Sadwrn with Saturninus in the Roman Martyrology, as is commonly done. Sadwrn is the Welsh form of Saturnus, and Saturninus would in Welsh be

Sadyrnyn, which actually occurs as the name of a sixth-century saint, the son of Sadwrn Hên, son of Cynyr of Caer Gawch and brother of S. Non To this saint the church of Llansadwrnen, in Carmarthenshire, is dedicated The festival of the latter is not given in any of the Welsh kalendars; but Rees, through confusing the two saints, gives it under this day.

Sadyrnyn was also the name of a bishop of S. David's, who died about 831

EGELWIN was brother of Kenwalch, King of the West Saxons He was a man of infirm health, but of great piety, and resignation to the will of God He was venerated at Athelney, where, however, the abbey had not at that time been founded. He lived in the seventh century.

30 TUGDUAL, *B. Ab Brittany, 6th cent. (L.)*.

TUGDUAL. See "Les Trois vies anciennes de S. Tudwal," by A. de la Borderie, Paris, Champion, 1877.

DECEMBER

1 GRWST, *C. Denbighshire, early 7th cent.*

DEINIOL WYN, OR THE BLESSED, *B. Bangor, 6th cent.; also September 11, December 10 (L.)*.

GRWST OR GORWST was of the family of Urien Rheged, and founded the church of Llanrwst, Denbighshire. He lived early in the seventh century

2 ISSERNINUS, *B. Ireland, A D 469.*

LLECHID, *V. Carnarvonshire, 6th cent.*

TRUMWIN, *B. Picts, A D 686 (L.); also February 10.*

ISSERNINUS, a Briton by birth, was summoned by S. Patrick to assist him in his work in Ireland. Isserninus had as his associate Auxilius; and for an account of their journey see the note on the latter (*September 16*). He is said to have received clerical orders the same day that Patrick was consecrated bishop. He was appointed to be bishop at Kilcullen, and attended the synod at Armagh in 456. He died in 469 The Church in

Ireland certainly owes to Isserninus a great debt of gratitude as one of her founders.

LLECHID was a daughter of Ithel Hael, and sister of several saints.

- 3 LLEURWG or LUCIUS, *K. C. Wales and Coire* (L)
BIRINUS, *B. Dorchester, in Oxfordshire*, A.D. 654 (L).
- 4 OSMUND, *B. Salisbury*, A.D. 1099 (L)
- 5 CAWRDAF, *K. Brecknockshire*, circa A.D. 560
JUSTINIAN, *H M. Ramsey, off Pembrokeshire*, circa A.D. 540.

CAWRDAF was the son of Caradog Freichfras, or Strong r' the Arm Caradog was grandson of Brychan and Earl of Gloucester, a contemporary of King Arthur, and, in the legendary story, one of the Knights of the Round Table, and Keeper of the Castle Dolorous The wife of Caradog and mother of Cawrdaf was Tegau Eurfron, or Of the Golden Breast, celebrated by the bards as one of the *three* chaste women of Britain, who possessed three valuable ornaments, a knife, a golden cup, and a mantle, the latter of which is the subject of a famous ballad given by Percy in his "Reliques" It was one that could only be worn by a really chaste woman It could be contained between two nut-shells, and had the property—

" Itt shall never become that wiffe
That hath once done amisse."

When Guenever tried it on—

" Shee stooode as shee had been madd.
It was from the top to the toe
As sheeres had it shread.
One while it was gule (red) ;
Another while was itt greene ;
Another while it was wadded (woaded—blue),
Ill itt did her beseme.
Another while it was blacke
And bore the worst hue :
By my troth, quoth King Arthur,
I thinke thou be not true."

But when the wife of Caradog Freichfras put on the mantle—

“ Upp at her great toe
 It began to crinkle and crowt ;
 She said, Bowe downe, mantle,
 And shame me not for nought
 Once I did amisse,
 I tell you, certainlye,
 When I kist Craddocke’s (Caradog’s) mouth
 Under a green tree ;
 When I kist Craddocke’s mouth
 Before he married mee
 When she had her shreeven
 And her smes had tolde,
 The mantle stood about her
 Right as she wold,
 Seemelye of color,
 Glittering like gold
 Then every knight in Arthur’s court
 Did her behold.”

So was the knife a token of fidelity, and that Craddocke won Caradog had by this good wife six sons, of whom Cawrdaf was the eldest. On the death of Caradog he succeeded his father in the rule over Brecknock and Fferergs, which comprised a part of Herefordshire. In the triads he is spoken of as one of the three prime ministers of Britain, also as one of the seven blessed first cousins of Britain. He was married and left issue, Cadell, Cathen, Iddawg, and Medrod. Later in life he became a member of the college of S Iltyd, and died about 560. A saying attributed to him is, “The promoter of work is the cautious hand.”

JUSTINIAN or STINAN was a native of Brittany, who came to Wales, and settled in the island of Ramsey, off Pembrokeshire, where he lived an eremitical life, and enjoyed the confidence of S. David. He was murdered, it is said, because he had reproved the vices of some of the Welsh, who took offence at his plain speaking. According to the legend, they cut off his head, whereupon a spring welled up on the spot. Then his body got up, and taking the head between the hands, walked down to the shore, passed over on the water to the mainland, and then fell. Thereupon S. David buried head and body with great solemnity. This is merely a fanciful way of saying that after the murder, S. David transported the dead man to the mainland, and saw to its interment. The date is about 540.

6

7 BUITH OR BOETHIUS, *C. Scotland*, A. D. 521.

BUITH OR BOETHIUS was a Scot, who rambled about the Continent for some thirty years, and made the acquaintance in Germany of S Codrus, with whom he returned to North Britain, where he restored to life the daughter of the King of the Picts. He received a grant of lands at Carbuiddo, near Dunnichen, and died the same day on which S. Columba was born, 521.

8

9 BUDOC, *Ab. B Dol*, 6th cent

ETHELGIVA, *V Abs. Shaftesbury*, A. D. 896.

BUDOC. There were three of this name : (1) an abbot in the isle of Bréhat, about 470, who educated S. Winwaloe, (2) a bishop of Dol, who succeeded S. Samson in 585 ; (3) a bishop of Vannes, about 600.

ETHELGIVA, daughter of King Alfred the Great and Ethelwitha. Her father built and endowed the monastery of Shaftesbury, and appointed her abbess. After a life of great sanctity she died in 896.

10 DEINIOL OR DANIEL, *B. Bangor*, 6th cent. (L.).

11 BERIS OR BERRYS, *C. Denbighshire*, of unknown date.

CIAN, *C. Carnarvonshire*, 6th cent.

CIAN, a warrior, who is mentioned by Aneurin in the "Gododin," and is supposed to have retired to Wales, where he devoted his life to religion. He is spoken of as "servant of S Peris" (July 26).

12 FINNAN, *B. Clonard*, A. D. 552 (L.).

FFLEWYN, *C. Anglesey*, 6th cent.

FFLEWYN was the son of Ithel Hael, and with his brother Gredifael was appointed by Pawl Hên to preside over the monastery of Ty Gwyn, on the Taf, when he was old and failing

- 13 GWYNAN and GWYNWS, *CC Wales, 5th cent.*
 JUDOC, *P.C. Ponthieu, 7th cent*, see *January 8 and July 25 (L.)*.
 FFINAN, *B. Anglesey, 6th cent.*

GWYNAN and GWYNWS were descendants of Brychan Llanwnws, in Cardigan, is dedicated to the latter.

FFINAN, a saint, bishop, and philosopher, who was descended from a noble family in Ireland, and resided with S David at Menevia about 530. According to Irish accounts, a king in Wales was so great an admirer of his virtue, that he granted him lands, and even a town there, and he erected three churches and spent twenty years there. The Welsh records do not confirm any of these statements. Finan is no other than the illustrious Finnian of Clonard, commemorated on February 23 and on December 12, on which day his life is given in the text.

- 14 FINGAR, *M*, and PIALA, *V.M. Hayle, Cornwall, 5th cent.*; see *March 23 (L.)*.
 15 DROSTAN, *B. Scotland, circa A.D. 600.*

DROSTAN was a companion of S. Columba on the occasion of the visit of the great Irish saint to Bede, the Pictish prince, at Aberdour, in Buchan. The site of the Abbey of Deer was given to them, and S. Columba left Drostan there as first abbot. Drostan was of the royal stock of the Scots. His date is about 600

- 16 BEAN, *B. Mortlach, Scotland, A.D. 1012 (L.)*.
 17 TYDECHO, *C. Merioneth and Montgomery, middle of 6th cent.*

TYDECHO, son of Amwn Ddu, or the Black, was cousin of S Cadfan. He left Armorica along with his sister Tegfedd, and settled in the district of Mawddwy, in Merionethshire. There he was much troubled by Maelgwn Gwynedd, prince of North Wales, upon whom he retaliated by performing a host of miracles, and forced the tyrant to make amends. Then his

sister Tegfedd was abducted by another chief, Cynon, who, however, was in like manner compelled to restore her unhurt. Tydecho is named in the Life of S. Padarn. He belongs to the middle of the sixth century. His legend was put into verse by a bard of the fifteenth century ("Cambrian Register," ii. 375-385; III. 540)

18 FLANNAN, *B. Killaloe, 7th cent. (L.).*

19 SAMTHANA, *Abss. Clonebrone, Ireland, 8th cent.*

20

21

22 ERNAN, *Mk. C. Drumhome, in Donegal, A.D. 640 (L.), also January 1.*

23 MAZOTA, *V. Abernethy, 7th cent. (L.).*

FRITHEBERT, *B. Hexham, A.D. 766.*

FRITHEBERT succeeded Acca as Bishop of Hexham. He ruled as well the diocese of Landisfarne during the imprisonment of Cynewalch, the bishop. "The time was one of anarchy after the death of Edbert. Men of unknown lineage disputed the throne with the kings of royal stock; revolts of the nobles added to the general disorder; and the fierce blood-shedding which characterised the successive strifes for the crown showed the moral deterioration of the country. Isolated as Northumbria had become, its isolation became even more pronounced in these fifty years of anarchy; for even the intermarriages of its kings with the other kingly houses all but ceased, and the northern realm hardly seemed to form part of the English people

"In spite, however, of this anarchy, Northumbria remained to the last the chief seat of English religion and English learning. In the midst of its political disorder, learning and the love of books still flourished at Jarrow and York."¹

24 LEVAN, *B. Treguier, Brittany, and Cornwall (L.).*

¹ Green, "The Making of England," ed. 1897, vol. ii p. 186.

- 25 BATHAN,
- B Shetland*
- , A.D. 639.

ALBURGA, *W Wilton*, circa 800.

ALBURGA was sister or half-sister on her mother's side to Egbert, King of Wessex, and had to husband Wolstan, Earl of Wiltshire. He repaired the church of Wilton, and on his death his widow retired into a convent which she established in connection with the church at Wilton. She died in 800 or thereabouts. It is to be regretted that a church so full of rich English memories should have been reconstructed in a flashy Italian style, entirely at variance with English traditions.

- 26 TATHAN OF TATHÆUS,
- Ab. Caerwent, and in Glamorgan*
- ,
-
- early 6th cent*

MÆTHLU OR AMAETHLU, *C Anglesey, 6th cent*JARLATH, *B. Tuam*, circa A.D. 560 (L.).

TATHAN OR TATHÆUS was a son of Amwn the Black, brother of Samson of Dol, and was a member of the college of S Illyt, after which he settled in Glamorganshire, and founded a church. A legend of the twelfth century makes him a son of a King of Ireland, and this error derogates from the value of the rest of the story. Leaving Armorica, he, with seven others, took boat and came to Wales, and landed in Gwent, where they fastened their boat to an anchor, which they struck into the sand. Some mischievous person, when they were at dinner with a landowner on shore, loosed the rope; but a stag hasted from the forest and held the rope with his feet. S. Tathan then ordered that the stag should be killed and eaten; his disciples were greatly shocked, but the stag lay down and stretched out his neck for the knife.

S. Tathan was granted land at Gwent, and he kept there a cow, which supplied him and his disciples with milk. One night some men turned forty-seven horses into his field, and they spoiled and ate his hay. As a chastisement all the horses were struck dead; but when those who had turned the horses into the field came and apologised, Tathan restored them all to life.

Tathan then went to the banks of the Severn and settled there. King Gwynllyw, then in an unconverted condition, one day invited the saint to him, and he provided as his seat a caldron full of boiling water, over which rushes were strewn. He invited the saint to sit down on the rushes, expecting him to go into the scalding water, but miraculously the rushes became

so stiff as to prove "a heavenly support." The legend of S. Tathan is obviously composed out of popular ballads, which the monkish scribe has rendered into Latin verses here and there

In the Life of S. Cadoc he is mentioned. It was he who baptized that saint. The story goes that when the servant of Gwynllyw complained at having to fetch water for the rite, and said that he was tired, and that it was a long climb up the hill, burdened with water, Tathan prayed, and forthwith a fountain miraculously sprang forth, at sight of which Cadoc, with three jumps from his nurse's arms, plunged into the water. Tathan was given Cadoc to educate. After Cadoc had plunged into the fountain, it flowed for some time with metheghn; that is to say, in plain English, that King Gwynllyw had a great carouse at the christening of his son, and mead flowed freely

Cadoc, or, as he was then named, Cathmael, was taught Latin and grammar by Tathan. It was whilst with him, and as a boy, that one day, when the fire was gone out, his master sent him to a husbandman who was drying his oats over a stove or hippocaust, to let him have some live coals. The fellow said he might take them if he would carry them in the lap of his garment. Cadoc took them up, but cursed the boor, on which at once fire broke out and consumed him, his threshing-floor, and his agricultural implements. Cadoc then went on, bearing the red-hot charcoal to his master in the fold of his garment. When Tathan saw this, he exclaimed, "Most dear disciple, it is not for me to teach you any more," and he dismissed him. Tathan is said to have dug a hole, and hidden the red-hot sacred coals in it, as a precious treasure, and there they remained, visited and wondered over by many men till the latter part of the eleventh century, when the place was lost. Probably there was some spot where a coal seam had become ignited, and popular romance attributed it to S. Cadoc, and the story was told that it was fire brought miraculously by him, and put into the rock by S. Tathan. A saying attributed to him, after a great loss, is "God will not apportion unjustly"

MAETHLU or AMAETHLU was the son of Caradoc Freichfras, by Tegau Eurfron (of the Golden Breast), the Chaste, and possessor of the marvellous mantle. He founded Llanfaethlu, in Anglesey.

29 THOMAS À BECKET, *Abp. M Canterbury*, A D 1170 (L)

THOMAS À BECKET The authorities are in the nine volumes of the Historical Society of Great Britain, "Materials for the History of Thomas Becket." See also Dom. A. L'Huillier "Saint Thomas de Canterbury," 1891

30 EGWIN, *B. Worcester*, A.D. 717, also January 11 (L)31 MAELOG, *C. Wales, 6th cent*

PAWL HËN, *Ab. B Wales* (see November 22).

MAELOG, son of Caw, was one of the congregation of S. Cadoc. It is to be surmised that he was hardly with him in Scotland when S. Cadoc dug up his father, restored him to life, and converted the resuscitated prince into a delver, as a common labourer, or he would surely have raised objections (see CÆWYDD, July 1). Maelog, and his sister Peithian, and brothers Eigrad, Peirio, and Galgo, settled in Anglesey, in separate hermitages, but with their sister in the midst, in the beginning of the sixth century.

PEDIGREES OF THE BRITISH SAINTS

The materials available for the pedigrees of the Welsh Saints are these:—

- 1 Bonedd y Sant, in "Myvyrian Archaiology" (Denbigh, 1870), pp 417-431.

In this the Saints are arranged alphabetically, and was compiled by Lewis Morris in the year 1760, from a number of Welsh MSS. containing pedigrees of the Saints.

- 2 In connection with this, information is obtainable from the collections of triads in the same work.
- 3 Bonedd Saint Ynys Prydain, in the same collection, pp 415-6 This is from a much older MS. than 1, as a whole.

None of these are translated.

- 4 Achau Saint Ynys Prydain, in the "Iolo MSS." (Llandovery, 1848), text, pp 100-109; English, pp 495-507.
- 5 Tair Gwelygordd Saint Ynys Prydain, *ibid.* pp. 109-114, 508-514
- 6 Achau a Gwelygorddau Saint Ynys Prydain, *ibid.* pp. 115-134, 515-537.
- 7 Achau Saint Ynys Prydain (not the same as 4), *ibid.* pp 135-146, 538-551.
- 8 Man-gofion am rai o Saint Ynys Prydain, *ibid.* pp. 147-153, 552-559.
- 9 Achau y Saint (different from 4 and 6), in "Lives of the Cambro-British Saints" (Llandovery, 1853), pp 265-268; English, 592-597.

- 10 Achau Saint Cymreig, *ibid.* pp. 269-271, English, 598-pp. 601
- 11 De Brachan Brecheinauc, *ibid.* pp. 272-275; English, pp. 602-608
- 12 Cognacio Brychan, from Cotton. Lib and Harleian MSS, printed in Jones's "History of Brecknock" (Brecknock, 1805), vol. II. pp. 342, 343
13. A Jesus Coll Cognacio, given by Jones, Appendix V.
- 14 Pedigrees from Jesus College MS. 20, printed in "Y Cymmrodor," VIII 83-90 (1887)
- 15 Bonedd Saint Kymry in the Mostyn MS 114 (*circa* 1592), of which a transcript is printed in the "Report on MSS in the Welsh Language" (Historical MSS. Commission, I. 54-55, 1898)
- 16 "Bonedd y Saint" in "Y Cymmrodor," VII 133-4 (1884), from a thirteenth or early fourteenth fragment among the Hengwrt MSS.

ERRATA

VOL. I.

- Pages 38 and 44, date of S. Melor, *for* '411' *read* '544'
" " last line, *for* 'brother' *read* 'brother-in-law.'

VOL. II.

- Page 239, line 18, *for* 'Cwynedd' *read* 'Gwynedd'
" 240, line 12, *for* 'plebian' *read* 'plebeian.'
" 346, in list of saints, last line, *for* 'Haselborough, in Wiltshire' *read* 'Haselbury, in Dorset.'
" 443, line 5 of small print heading, *for* 'Du curand' *read* 'De curand.'

VOL. III.

- Page 13, last line, *for* 'wild' *read* 'wilt.'
" 50, first line, *for* 'Cornonaille' *read* 'Cornouaille.'
" 282, plate, after 'painting' *read* 'by Qunten Matsys in the Antwerp Museum.'

VOL. IV.

- Page x, *for* 'S Mark' *read* 'S. Luke.'
" 1, Calendar, line 10, *for* 'civc AD 1211' *read* 'A.D. 1245'
" 10, line 29, *for* '(about AD 1211)' *read* '(A.D. 1245).'
" 336, illustration, *for* 'S Mark' *read* 'S. Luke (vol. III. p 467)'

VOL. V.

Page 20, last line, *cancel* 'but whether,' to page 21, line 2, 'unknown,' and *substitute* 'that is to say, S German of Auxerre, on one of his two visits to Britain, or in one of the monasteries he then founded.'

- „ 21, line 7, *for* 'Rignal' *read* 'Rigual'
- „ 21, line 8, *for* 'Gonet' *read* 'Gouet.'
- „ 314, plate, *for* 'Jules Romain' *read* 'Julio Romano.'
- „ 414, line 2, *for* 'Hechla' *read* 'Heckla'
- „ 414, line 7, *for* 'Ishel' *read* 'Isluf.'

VOL. VI.

Page 230, below illustration, *vid* 'S. Avitus (see p 237).'

- „ 289, line 10, *for* 'Amwn Dhu' *read* 'Amwn Ddu.'
- „ 289, line 11, *for* 'Meury' *read* 'Meurig.'
- „ 295, line 25, *cancel* 'the pseudo'
- „ 322, under illustration, *for* 'Nativity of S John the Baptist' *read* 'The Trinity.'
- „ 324, illustration, *for* 'Ghirlandago' *read* 'GhirlandaJo.'

VOL. VII.

Page 1, line 7, *cancel* 'the pseudo.'

VOL. VIII.

Page x, *for* 'Cordis Jesu' *read* 'Salvator Mundi'

- „ 616, plate, *for* 'Le Sueier' *read* 'Le Sœur.'

VOL. IX

Page 146, plate, *for* 'S Eloi' *read* 'S Eligius.

- „ 262, plate, *for* 'cathedral' *read* 'church.'

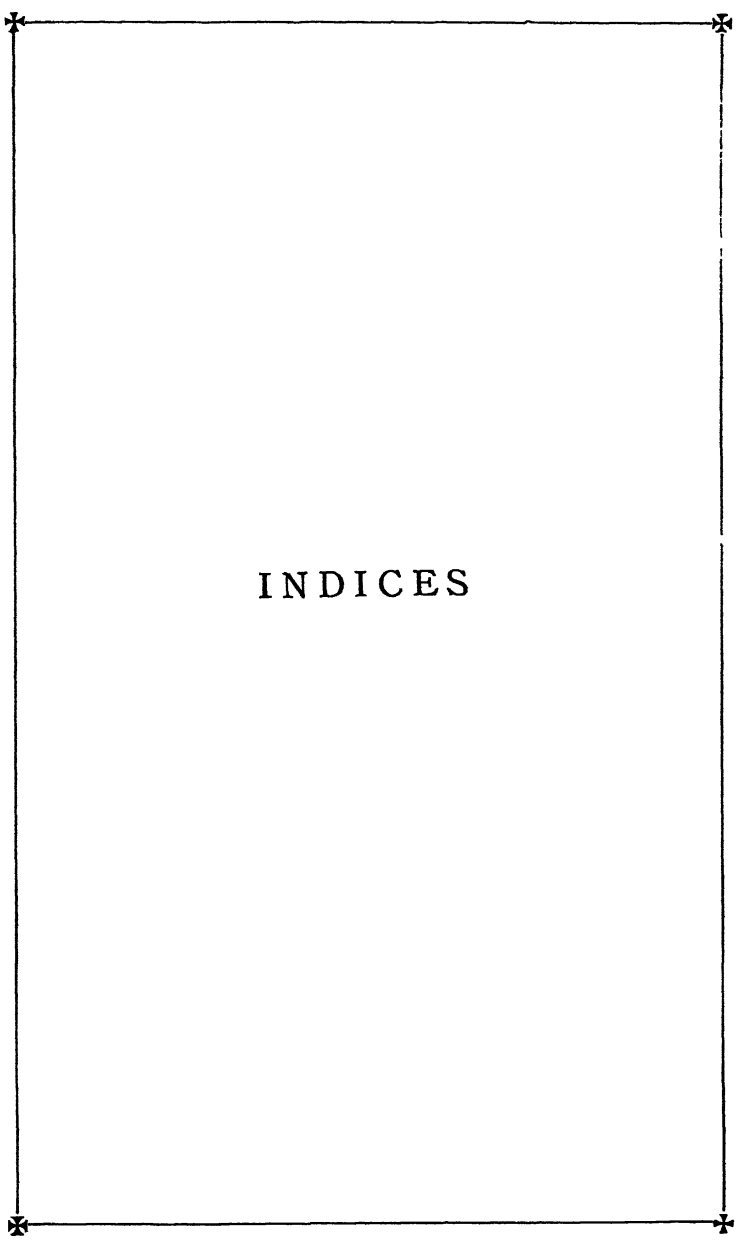

INDICES

INDEX TO SAINTS WHOSE LIVES ARE GIVEN

[The following contractions are used to indicate the months — Jan (January), F (February), Mch (March), Ap (April), My (May), Ju (June), Jly (July), Au. (August), S (September), O. (October), N (November), D (December), *Apdx.* (1 of xvi)]

- | | |
|--|--|
| <p>S. AARON, Appdx. 245
 SS Aaron and Julius, Jly. 1
 S. Abban of Kilabban, O. 652
 „ Abban of Maghamoidhe, O 653
 SS Abdon and Sennen, Jly 677
 „ Abibus and comp, N. 334
 S Abra, D 170
 „ Abraham, F. 298
 SS Abraham and Mary, Mch 275
 „ Abrosimus and comp, N 230
 S Abundius, Ap 24
 SS Abundius, Abundantius, and comp, S 261
 „ Abundius and Irenæus, Au 314
 S Acca, Au. 80
 „ Acca, B of Hexham, O 501
 SS Acepsumas and comp, Ap 298
 S Achilles, N. 168
 SS Achilles and comp, Ap 300, and My. 158
 S Adalbold, F 41
 „ Adalbert, Ap. 311, Ju. 361
 „ Adalhardt, Jan 34
 „ Adalsendus, D 280
 „ Adamnan, S 358
 SS Adauctus and Callisthene, O. 64
 „ Adauctus and Felix, Au 383
 „ Adela and Imina, D. 274
 S Adelelm, Jan 461
 „ Adelhard, Empress, D. 161
 „ Adelheid, F. 140
 „ Adeloga, F. 42
 „ Adeodatus, Jly. 357</p> | <p>S. Ado, B. of Vienne, D. 199
 „ Adrian, Jan. 128
 „ Adrian, B of S. Andrews, Mch. 59
 „ Adrian, M. at Wintershoven, Mch. 333
 SS Adrian, Natalia, and comp, S 113
 S Aelhaiarn, Appdx 288
 „ Aelred, Jan. 176
 „ Æmilian, F 212, Ju. 360, N. 292
 „ Afan, Appdx. 305
 „ Afra, Au 59
 SS African Martyrs, Ap. 73
 „ Agape and comp, Ap. 34
 S. Agapetus, Au 162
 „ Agapetus I, Pope, S. 321
 „ Agapius, N 458
 SS. Agapius and comp., Au. 179
 S. Agatha, F. 136
 „ Agatho, Jan. 137
 „ Agathochia, S. 272
 SS Agathopus and Theodulus, Ap. 61
 S Agilulf, Jly 211
 „ Agieus, O. 357
 „ Agnes, Jan. 317
 „ Agricola, Mch. 285
 SS Agricola and Vitalis, N. 107
 S. Agrippina, Ju. 308
 „ Aibert, Ap 114
 „ Aichard, S 249
 „ Aidan, Jan. 467, Au 391, Appdx. 177</p> |
|--|--|

- S Aignan, B. of Orleans, N. 378
- SS Agulf and comp., S 41
- S Ailbe, S 180
- „ Alban, M., at Mainz, Ju 288
- „ Alban, M., at Verulam, Ju. 294
- „ Alberta, Mch. 212
- „ Albinus, Mch. 16
- „ Alburga, Appdx. 324
- B. Alcuin, My. 263
- S. Aldate, Appdx 179
- „ Aldate of Gloucester, Ju. 203
- „ Aldegund, Jan 460
- „ Aldetrudis, F. 413
- „ Aldhelm, My 346
- „ Aldric, Jan. 96
- „ Alena, Ju 246
- „ Alexander, F. 443, Au 315, S. 325
- „ Alexander I, Pope, My 54
- „ Alexander of Apamea, Mch. 203
- „ Alexander of Jerusalem, Mch 312
- „ Alexander Accemetus, Jan. 228
- „ Alexander Nevski, N. 511
- SS Alexander and comp., My. 418, Jly 207, O 564
- „ Alexander and Epimachus, D. 156
- S. Alexis, Jly 413
- B Aleydis of Scharembeke, Ju. 147
- S. Alfred the Great, Appdx 285
- „ Alfric, Appdx. 305
- „ Alfwold, Mch. 460
- „ Algeric, B. of Verdun, D 2
- „ Alkmund, Mch 334
- SS. Alkmund and Gilbert, S. 109
- All Saints, N. 1
- All Souls, N. 42
- S. Almedha, Au. 6, Appdx 258
- „ Alnoth, F. 448
- SS Alodia and Nunilo, O. 575
- S. Aloysius Gonzaga, Ju. 291
- SS. Alphæus and Zacchæus, N. 378
- S. Alphege, Ap 229
- „ Alphonso Liguori, Au 21
- S Almann of Passan, Au. 102
- „ Alypius of Tagaste, Au 144
- „ Amaethlu, Appdx 325
- „ Amalberga, Jly 262
- „ Amandus, F. 182
- „ Amantius, Mch 333
- „ Amator, My. 11
- „ Amatus of Lorraine, S. 192
- „ Amatus, B of Sens, S. 194
- „ Ambrose, D. 74
- „ Ambrose, B of Cahors, O 433
- „ Ambrose of Sienna, Mch 369
- „ Ammon, O- 64
- SS. Ammon, Zeno, and others, D 224
- „ Ammonarium and others, D. 156
- S. Amphilochius, N 509
- SS Amplias and comp, O 724
- „ Ananias and comp, F. 412
- S. Anastasia, D 278
- SS. Anastasia the Elder, and Cynl, O. 697
- S. Anastasius, Ap. 353, S 100
- „ Anastasius II, Patriarch of Antioch, D. 234
- SS. Anastasius and comp Jan 334
- „ Anatholia and Audax, Jly 203
- S. Anatolus, B. of Constantinople, Jly 95
- „ Anatolus, B. of Laodicea, Jly 92
- SS Andochius, Thyrsus, and Felix, S. 361
- S Andrew, Apost M, N 593
- „ Andrew of Crete, Jly 106, O. 451
- „ Andrew of Rinn, Jly. 302
- „ Andrew the Tribune, Au. 177
- „ Andrew Avellino, N. 233
- „ Andrew Corsini, F 105
- SS Andrew and comp, My 205
- „ Andronicus and Athanasia, O. 198
- „ Andronicus and comp, O 260
- S. Anectus, Ju. 387
- SS. Aneurin and Gwynoc, O. 646
- B Angela of Foligni, Jan. 63

- S. Angela of Merici, My. 430
 „ Angilbert, F 337
 „ Angus of Keld, Mch 217
 „ Anicetus, Ap. 219
 SS Anicetus and Photius, Au 115
 S Annas, Mch. 274
 „ Anne, Jly. 564
 „ Anno, Abp of Cologne, D
 29
 Annunciation, B. V Mary, Mch.
 450
 S. Ansbert, F 246
 „ Ansegi, Jly. 492
 „ Anselm, Ap 261 —
 „ Ansewin, Mch 252
 „ Anskar, F 56
 „ Anteros, Jan 38
 „ Anthelm of Bellay, Ju. 378
 „ Anthimus, Ap. 353
 „ Anthony, Jan. 249
 SS. Anthusa and Athanasius, Au.
 232
 „ Antia and Eleutherus, Ap.
 223
 S. Antidrus, Ju 352
 SS. Antiochus and Cynac, Jly
 351
 S. Antipas, Ap 136
 „ Antonina, Mch 8
 „ Antoninus, S 11
 SS Antoninus and comp , N 311
 S Antony of Padua, Ju 181
 „ Anysia, D 406
 „ Anysius, B. of Thessalonica,
 D. 406
 „ Aphraates, Ap 112
 „ Aphrodisius, Ju. 282
 „ Aphrodisius of Beziers, Mch
 407
 „ Aphrodisius of Carthage, Mch
 256
 SS. Aphrodisius and comp , Ap
 358
 S. Apollinaris, Jly. 519
 „ Apollinaris Syncret, Jan. 70
 SS. Apollinaris and Timothy, Au
 243
 S Apollinarius, O 118
 „ Apollo, Jan. 372
 „ Apollonia, F. 231
 S. Apollonius, Mch. 156, Jly.
 165, Ap 224
 SS. Apostles, The Separation of
 the, Jly. 347
 Apparition of the Cross, The, Au
 180
 Apparition of S. Michael, My.
 115
 S. Apphian, Ap. 12
 SS. Appia and Philemon, N. 501
 S. Apronia, Jly 357
 SS. Apuleus and Marcellus, O.
 154
 „ Aquila and Priscilla, Jly. 182
 S. Aquilina, Ju. 177
 SS. Aquilina and Niceta, Jly.
 526
 S. Arbogast, Jly 501
 „ Arcadius, Jan 162
 SS. Archelaa and others, Jan. 278
 S Ardalo, Ap. 189
 SS. Arethas and comp , N. 514
 „ Arald and Herlembald, Ju
 389
 S. Arida, O. 723
 „ Arstarchus, Au. 34
 „ Arstion, F. 366
 „ Aristobalus, Mch. 266
 „ Armel, Appdx., 264
 SS Armogastes and comp , Mch.
 496
 S Arnulf, Jly. 435, Appdx 268
 „ Arnulf of Villars, Ju. 488
 „ Arsacius, Au. 150
 „ Arsenius, Jly. 446
 „ Artemas, Jan. 370
 „ Artemus, O. 496
 „ Asaph, My 16
 S. Asclas, Jan. 346
 SS. Asclepiodotus, Maximus, and
 Theodotus, S. 247
 S. Asella, D. 68
 „ Aspren, Au. 24
 Assumption of the B. V. M., The,
 Au. 141
 S. Asterius, Mch. 42, O 505
 SS. Asterius and comp., Au 238
 „ Asyncritus and comp., Ap
 121
 S Athanasius, Jan. 38

- S Athanasius, Deac., Jly. 127
 „ Athanasius the Great, My 29
 SS Athanasius and Anthusa, Au. 232
 S. Atracta, F 236
 „ Attala, D 20
 „ Atticus, Jan 100
 SS Auceas and Luceja, Ju 342
 „ Audax and Anatholia, Jly 203
 S. Audifax, Jan 285
 „ Augulus, F 190
 „ Augurius, Jan. 312
 „ Augusta, Mch. 483
 „ Augustine, My 384
 „ Augustine of Hippo, Au. 351
 SS Augustinus and comp, S 89
 S Aurea, O. 66
 SS Aurelius, Sabagotha, and comp., Jly 588
 „ Aureus and Justina, Ju 221
 S Austell, Appdx 243
 „ Austremonius, N 20
 „ Austrude, O 447
 „ Autbert, B. of Cambrai, D 171
 „ Autonomus, S 178
 „ Auxentius, F. 299
 „ Auxibius, F. 339
 „ Auxilius, Appdx. 275, 316
 „ Aventine, Ju 75
 „ Aventine of Chateaudun, F. 86
 „ Aventine of Troyes, F. 84
 „ Avia, My. 94
 „ Avitus, F. 138, Ju. 237
 „ Aya, Ap. 226
 SS Azades and comp, Ap. 298

 S BABOLEN, Ju. 373
 „ Babylus, Jan 361
 SS Bacchus and Sergius, O. 155
 S. Baithen or Baitan, Appdx. 232
 „ Balbina, Mch 513
 „ Baldenc, O. 427
 „ Baldomer, F. 447
 „ Baldwin, Jan 112
 „ Balthazar, Jan. 148
 „ Balther and Bilfred, Mch. 94

 S Barachisus, Mch 491
 „ Baradatus, F. 368
 „ Barbara, D 25
 „ Barbatuf, F. 342
 B Bardo of Mainz, Ju 133
 S Barhadbesciabas, Jly 500
 „ Barlaam of Antioch, N 413
 SS Barlaam and Josaphat, N 562
 S Barnabas, Ju 139
 „ Barrwg or Barruc, Appdx 317
 „ Barsas of Edessa, Jan 460
 „ Bartholomew, Ap., Au 253
 „ Bartholomew of Farne, Ju. 338
 „ Barypsabas, S 147
 „ Basil of Amasea, Ap. 350
 „ Basil of Ancyra, Mch 407
 „ Basil the Great, Ju. 192
 S Basilides and comp, Ju 149
 „ Basiliscus and comp, Mch. 44
 S. Basilissa, S 35
 „ Basilla, My. 306
 „ Basinus, Mch 59
 SS Bassa and sons, Au. 223
 S Bassian of Lodi, Jan. 286
 „ Bathild, Jan. 394
 SS Bathus, Verca, and children, Mch. 468
 S. Bavo, O. 13
 „ Bean, B of Mortlach, D 203
 „ Beata, S. 89
 SS Beatrix, Simplicius, and Faustinus, Jly. 631
 S. Beatus, My 136
 „ Bede the Venerable, My. 398
 „ Bede the Younger, Ap 132
 „ Bega or Bee, S 92
 „ Beggha, D 207
 „ Begha, N 27
 „ Belma, F 344
 „ Bellinus, N 548
 „ Benedict, Mch, 388
 „ Benedict II, Pope, My. 108
 „ Benedict Biscop, Jan. 167
 „ Benedict of Aniane, F 284
 „ Benedict the Black, Ap. 59
 „ Benet of the Bridge, Ap. 198
 „ Benignus, Abp. of Armagh, N. 222

- S Benignus of Dijon, N. 12
 ,, Benjamin, Mch 515
 ,, Benno of Meissen, Ju. 222
 ,, Beisach, F. 307
 ,, Bercharius, O. 431
 SS Berence and comp, O 63
 S. Berhnda, F. 50
 ,, Bernard, B of Hildesheim,
 N. 466
 ,, Bernard de Alzara and comp,
 Au 226
 ,, Bernard of Clairvaux, Au 196
 ,, Bernard of Menthon, Ju 213
 ,, Bernardine, My 309
 ,, Bertellin, S 139
 ,, Bertha, Jly 107
 ,, Bertilia, Jan. 51
 ,, Bertilla, N. 156
 ,, Bertun, S. 71
 ,, Bertoara, D 161
 ,, Bertrand, B of Comminges,
 O. 436
 ,, Bertulf, F. 139
 ,, Besas, F 442
 ,, Bessarion, Ju 236
 ,, Beuno, Appdx, 214
 ,, Bibiana, D 10
 ,, Bilfrid, Mch 94
 ,, Bilhild, N. 574
 ,, Binnus, B. of Dorchester, D.
 17
 ,, Birstan, Appdx 294
 SS Blauthmac and comp., Jan.
 289
 S. Blause, F 47
 ,, Blane of Bute, Au. 112
 ,, Bodagisl, D. 220
 ,, Bodfan, Appdx 229
 ,, Boethus, Appdx. 321
 ,, Boisil, Appdx. 174
 ,, Bolonia, O. 415
 ,, Bonaventura, Jly. 327
 ,, Bond, or Baldus, O. 708
 ,, Boniface, Lausanne, F. 343
 ,, Boniface I., Pope, O 636
 ,, Boniface IV., Pope, My. 345
 ,, Boniface of Mamz, Ju 41
 ,, Boniface of Tarsus, My. 191
 ,, Boniface Quintine, Mch. 279
 SS. Boniface and comp., Au. 159
 SS. Boniface and others, O 62
 ,, Bonosus and Maximilian, Au
 225
 ,, Boris and Gleb, S. 75
 S. Bosa, Mch 175
 ,, Botulph, Ju. 247
 ,, Botvid, Jly. 609
 ,, Bradan, B of Man, O 498
 ,, Braulio, Mch. 468
 SS Breaca and Ia., O. 657
 S Breacha, Ju. 36
 ,, Bregwun, Abp of Canterbury,
 Au 316
 ,, Bregwyn, Appdx. 269
 ,, Brendan of Clonfert, My. 217
 ,, Brice, B. of Tours, N 312
 ,, Bridget, F 14
 ,, Briget of Sweden, O 182
 ,, Brinstan, Appdx. 294
 ,, Broch, My. 20
 ,, Bristan, Appdx 194
 ,, Brithwald, Jan. 131
 ,, Britwin of Beverley, My 213
 ,, Brothen, Appdx. 281
 SS. Brothen and Gwendoline, O.
 476
 S. Bruno, F. 304, O. 141
 ,, Brynach Wyddel, Appdx. 209
 ,, Budoc, Appdx. 321
 ,, Budoc, B. of Dol., D 118
 ,, Buth, Appdx. 321
 ,, Burchard, B of Wurzburg, O.
 354
 ,, Burgundofara, or Fara, D. 105
 ,, Buriana, Appdx 226
 S. CADFAN, Appdx 288
 ,, Cadfarch, O. 616
 ,, Cadoc, Jan. 363, Appdx.
 174, 325
 ,, Cadwaladr, Appdx 280
 ,, Cæcilia, N. 502
 ,, Cæsarea, My. 211
 ,, Cæsaria, Jan 167
 ,, Cæsarius, F. 412
 ,, Cæsarius of Arles, Au. 343
 SS. Cæsarius and Juhon, N. 10
 S Cagnoald, S. 90
 ,, Caian, Appdx. 276
 SS. Caius and Alexander, Mch. 203

- SS. Caus and comp, O 50
 ,, Caus and Crispus, O 61
 ,, Caus the Palatine and comp.,
 Mch. 57
 S. Cajetan, Au. 87
 SS. Calepodius and comp, My 139
 S. Calliope, Ju 77
 ,, Calliopius, Ap. 110
 SS. Callisthene and Adauctus, O
 64
 ,, Callistratus and comp., S. 385
 S. Callixtus, Pope, O 347
 ,, Callwen, Appdx 288
 ,, Camillus of Lellis, Jly 442
 ,, Camin of Iniskeltra, Mch 458
 SS. Camerinus and comp, Au. 221
 S. Canog, Appdx 279
 SS. Cantius, Cantianus, and Can-
 tanilla, My. 428
 S. Canute, Jly. 264
 ,, Canute Lavard, Jan 97
 SS. Caprasius and comp., O. 495
 S. Caradoc, Ap 185
 ,, Caranog, or Carantog, Appdx.
 222
 ,, Carantog, My. 215
 ,, Caranus, My. 408
 ,, Carleff, Jly 12
 ,, Carnech, My. 214
 ,, Caron, Appdx 193
 ,, Carpus, O 319
 SS. Carpus and comp, Ap 180
 S. Carthagh of Lismore, My 196
 ,, Casimir, Prince, Mch 60
 ,, Cassian, Au 130
 ,, Castor, F 289
 ,, Castulus, Mch 467
 SS. Castus and Secundinus, Jly 3
 S. Cathan, Appdx. 222
 Catherine, N. 540
 ,, Catherine of Bologna, Mch.
 182
 ,, Catherine of Genoa, S. 252
 ,, Catherine de Ricci, F. 295
 ,, Catherine of Sienna, Ap 377
 ,, Catherine Audley, Appdx. 314
 ,, Cawrdaf, Appdx. 319
 ,, Ceadmon, F. 272
 ,, Ceadwalla, Appdx. 213
 ,, Cedd, Jan. 91
 S. Ceitho, Appdx. 287
 ,, Celerina, F. 46
 SS. Celestinus and comp, F. 46
 S. Celestine I, Ap. 94
 ,, Celsus, Ap 106
 SS. Celsus and Nazarius, Jly. 593
 S. Celynn, Appdx 287
 ,, Celynn, son of Cynyr Farf-
 drwch, Appdx 310
 SS. Censurrinus, Quinacus, and
 comp, S 67
 S. Ceolfind, S. 378
 ,, Ceolwulf, Jan 236
 ,, Cerbonius, O 228
 SS. Cerealis and others, Ju 127
 S. Cewydd, son of Helg, Appdx.
 245
 ,, Cian, Appdx 321
 Circumcision, The, Jan. 1
 SS. Cisellus and comp., Au 221
 S. Chad, Mch. 23
 ,, Chæremon, D 235
 SS. Chaialampius and comp, F.
 248
 S. Charlemagne, Jan 437
 SS. Charitas and comp., Au. 4
 S. Charitina, O 117
 B. Charles the Good, Mch 38
 S. Charles Borromeo, N. 111
 ,, Chelidomus, Mch. 44
 SS. Chonia and comp., Ap. 34
 S. Chlodulf of Metz, Ju 82
 ,, Christiana, Jan 146, D 189
 ,, Christina of Tyre, Jly 527
 ,, Christina the Wonderful, Jly.
 533
 ,, Christopher, Jly. 553
 ,, Chrodegang, Mch 96
 SS. Chromatius and Tiburtius,
 Au 113
 S. Chronion, F. 442
 SS. Chrysanthus and Daria, O.
 620
 S. Chrysogonus, N 513
 ,, Chrysolius, F 189
 Circumcision, The, Jan 1
 SS. Chrysteta and comp., O. 649
 S. Clair, N. 108
 ,, Clara, Au 120
 ,, Clara of Rimini, F. 256

- S Claudia, Au. 82
 SS Claudius, Asterius, and comp., Au 238
 „ Claudius and comp., F 329
 „ Claudius and Julia, Jly. 497
 „ Claudius, Nicostratus, and others, Jly. 167
 S Cledog, Au 181
 „ Cledwyn, Appdx. 287
 „ Clement, N 506, Appdx. 197
 „ Clement of Alexandria, D 23
 „ Clement of Ancyra, Jan 347
 „ Cleomicus, Mch 44
 „ Cleophas, S 374
 „ Clether, Appdx 265
 „ Cletus, Ap. 343
 „ Clodoald, S 104
 „ Clothilda, Ju. 23
 „ Clotendis, Ju. 486
 „ Clyda, Appdx. 288
 „ Clydog, Appdx. 294
 „ Clydwyn, Appdx. 287
 SS Codratus and comp., Mch 203
 S. Colette, Mch. 97
 „ Collen, Appdx 223
 „ Colman, Appdx 184
 „ Colman, Abbot, O. 669
 „ Colman, B of Kilruadh, O. 418
 „ Colman of Austria, O. 326
 „ Colman of Dromore, Ju. 71
 „ Colman MacDuach, O. 709
 „ Columba, Mch. 274, Ju 90, S. 279, N 314, D 411
 „ Columbanus, N 489
 „ Comgall, My. 141
 Commemoration of All Souls, N 42
 S Conan, Appdx. 176
 SS Conon and son, My. 417
 S Concord, Jan. 3
 SS. Concordia and Hippolytus, Au. 127
 „ Concordius, Zeno, and others, S. 12
 S. Congan, O. 325
 „ Conlaeth, Appdx. 195
 „ Conrad, B. of Constance, N. 547
 SS Constantia and comp., F. 330
 S. Constantine, Mch. 214, Appdx 198
 „ Constantine, Emperor, My. 314
 „ Conval, Appdx. 277
 Conversion of St. Paul, Jan 370
 S Convoyon, D 314
 SS Copres and comp., Jly. 207
 S Corbican, Ju. 373
 „ Corbiman, S 120
 „ Cordula, O 571
 „ Corentin, B. of Qumper, D. 157
 „ Cornelius, Pope, S 196
 „ Cornelius of Rome, F 314
 „ Cornelius the Cent., F. 38
 „ Cosmas, O 354
 SS Cosmas and Damian, S. 397
 S Cowair, Appdx 251
 „ Creurwy, Appdx 192
 „ Crescens, Ju. 386, D. 323
 SS. Crescentia and others, Ju 207
 „ Crescentianus and comp., S. 228
 S. Crescentius, S. 229
 „ Crewenna, Appdx. 179
 SS. Crispin and Crispinian, O. 628
 S. Crispina, D. 50
 SS. Crispus and Caius, O. 61
 S Cristolus, Appdx. 294
 „ Cronan, Ap 361
 Cross, Apparition of the, Au 180
 Cross, The Exaltation of the, S. 233
 S Crucifix at Berytus, N. 223
 Crucifixion, Memorial of, Mch. 254
 SS Ctesiphon and comp., My. 204
 S. Cuby, N. 186
 „ Cucuphas, Jly. 559
 „ Cumme, O. 133
 „ Cumme the White, Appdx. 186
 „ Cummian Fada, N. 304
 „ Cunera, Ju. 154
 „ Cungar, Appdx. 301
 „ Cumbert, Abp. of Cologne, N. 306
 „ Cuno, Ju. 6

- S Curg, Appdx 236
 ,, Cuthberga, Au 400
 ,, Cuthbert, Mch. 337, Appdx 285
 ,, Cuthbert, Translation of, S 50
 ,, Cuthman, F. 220
 ,, Cwyfan, or Cwyfen, Appdx. 230
 ,, Cwyllog, Appdx. 168
 ,, Cybi, Appdx 279
 ,, Cynbryd, Appdx 197
 ,, Cynddilig, Appdx 293
 ,, Cyndeus, Jly 277
 ,, Cyndeyrn, Appdx 254
 ,, Cynfab, Appdx. 305
 ,, Cynfarch, Appdx 272
 ,, Cynfarwy, Appdx 302
 ,, Cynfran, Appdx. 303
 ,, Cyngar, Appdx. 301
 ,, Cynhafal, Appdx. 279
 ,, Cynidr, Appdx. 216
 ,, Cynllo, Appdx. 253
 ,, Cynog, Appdx 279
 ,, Cynwyl, Appdx. 217
 ,, Cyprian, S. 203
 SS. Cyprian and Felix, O. 287
 ,, Cyprian and Justina, S. 386
 ,, Cyra and Marana, Au 28
 ,, Cyriac and Julitta, Ju. 219
 S. Cyriacus, Jan 163, Appdx. 236
 SS. Cyriacus, Largus, and Smaragdus, Au. 98
 S Cyril, Jly. 205
 ,, Cyril, Alexandria, Jan 418
 ,, Cyril of Helopolis, Mch 492
 ,, Cyril, Patr. of Jerusalem, Mch 314
 SS. Cyril and Anastasia, O. 697
 ,, Cyril and Methodius, Mch 176
 S. Cyrilla, O. 685
 ,, Cyrinus, Jan. 44
 ,, Cyrus of Carthage, Jly. 321
 SS. Cyrus, John, and others, Jan 465
 S. Cywar, Appdx. 251
 ,, Cywyllog, Appdx. 168
 S. DADAS, Ap. 181
 ,, Dafrosa, Jan. 57
 S Dagæus, Appdx 265
 ,, Dagan, Appdx 228
 ,, Dalmatius, Au 25
 ,, Damasus, Pope, D 137
 ,, Damian, F. 376
 ,, Daniel, Mch 517, Ap 325
 ,, Daniel the Stylite, D 142
 ,, Daria and Chrysanthus, O 620
 ,, Darlugdach, F 22
 ,, Datus, Jan. 210
 ,, Datus, Jly. 90
 ,, David, Mch 10, Ju 372, Appdx 187
 ,, David and Romanus, S 75
 ,, Declan, Jly 532
 ,, Decuman, Au 345
 Dedication of the Church of our Saviour, N 219
 S Deghadh, Appdx 265
 ,, Deicolus, Jan 280
 ,, Deifer, Appdx. 193
 ,, Demiol, B of Bangor, D. 128
 ,, Demiol the Carpenter, Appdx. 273
 ,, Demiol the Younger, Appdx 313
 ,, Demiolen, Appdx 313
 ,, Demiofab, Appdx 313
 ,, Delphinus, B. of Bordeaux, D. 271
 ,, Demetrius, O. 165
 ,, Dentlin, Jly. 323
 ,, Deodatus, Ju 259
 ,, Deogratus, Mch. 411
 ,, Derfel Gadarn, Appdx. 207
 ,, Deruvianus, Appdx 221
 ,, Desiderius of Langres, My. 334
 ,, Desiderius of Vienne, My. 335
 ,, Deusdedit, Abp. of Canterbury, Jly 357
 ,, Deusdedit, Pope, N 197
 ,, Devmic, N. 317
 ,, Devota, Jan. 399
 SS. Didymus and Theodora, Ap 359
 S. Digain, Appdx. 310

- SS Digna and Emerita, S. 328
 S. Dihaer, Appdx. 193
 ,, Diheifyr, Appdx 193
 ,, Dingad, Appdx 287
 ,, Diomede, Au 149
 SS. Dionysia and comp, My 205
 ,, Dionysia, Majoricus, and
 others, D 69
 S Dionysius, Ap 122
 ,, Dionysius (Augsburg), F. 432
 ,, Dionysius, B of Alexandria,
 N. 371
 ,, Dionysius, Pope, D. 299
 ,, Dionysius the Areopagite, O.
 190
 ,, Dionysius of Bulgaria, Ju.
 385
 ,, Dionysius of Cæsarea, Mch.
 444
 ,, Dionysius of Corinth, Mch.
 203
 SS Dionysius and comp., O 50
 ,, Dionysius, or Denys, and
 comp., O. 195
 ,, Dionysius and others, F. 212
 S Disibod, Jly. 187
 ,, Docmael, Appdx. 234
 ,, Doewan, Appdx. 252
 ,, Dogfan, Appdx. 252
 ,, Dogmael, Appdx 234
 ,, Dogwan, Appdx 252
 ,, Domangart, Mch. 445
 ,, Dominic, Au. 40
 ,, Dominica, Jly 137
 ,, Domitian, Jan. 136, My 108
 SS. Domnan and comp, Ap. 220
 S. Domneva, Appdx 309
 ,, Domnina, Mch 9, O 285
 SS. Domnina and comp., O. 63
 ,, Domno and Dommo, O. 703
 S. Dona, Appdx. 293
 ,, Donald, Jly 358
 SS. Donatian and comp, S. 89
 ,, Donatilla, Maxima, and Se-
 cunda, Jly. 678
 S. Donatus, Ap. 373, Ju. 484
 ,, Donatus, B of Fiesoli, O.
 575
 ,, Dorbhene, O. 700
 ,, Dorotheus, Mch. 222
 S. Dorotheus of Tyre, Ju. 40
 SS. Dorotheus and Gorgonius, S.
 131
 S Dorothy, F 176
 ,, Dositheus, F. 378
 ,, Drausinus, Mch 74
 ,, Droctoveus, 209
 ,, Drogo, Ap 217
 ,, Drostan, Jly. 278, Appdx. 322
 ,, Dubricius, Appdx 304, N
 327
 ,, Dubricius, Translation of,
 Appdx. 228
 ,, Dubtach, Appdx. 280
 ,, Dula, Mch 457
 ,, Dulas, Ju 208
 ,, Dunawd Fawr, Appdx. 272
 ,, Dunchad, Appdx. 201
 ,, Dunstan, Abp., My 276
 ,, Duthac, Mch. 164
 ,, Dwynwen, Appdx. 175
 ,, Dyfan, Appdx. 221
 ,, Dyfnan, Appdx 216
 ,, Dyfnog, Appdx 183
 ,, Dyfing, Translation of, Appdx.
 228
 SS. Dyfrwyr, the, Appdx 292
 ,, Dymphna and Gerebern, My
 207
 S. EADBERT, My. 96
 ,, Eadburg, Appdx 235
 ,, Eadfrid, Appdx 284
 ,, Eadsin, Appdx. 285
 ,, Ealsatha, Appdx 253
 ,, Eanswitha, Au 389
 ,, Earcongotha, F 382
 ,, Easterwin, Appdx. 193
 ,, Eata, O 647
 ,, Ebba, Au. 280
 B. Eberhardt, Ap. 114
 S. Ebrulfus, D. 324
 ,, Edbert, Appdx. 266
 ,, Edburga, Appdx. 233
 ,, Edeyrn, Appdx. 168
 ,, Edgar, Jly. 198
 ,, Edith of Polesworth, S. 267
 ,, Edith of Wilton, S. 269
 ,, Edmund, Abp. of Canterbury,
 N 349

- S Edmund, C, Appdx. 278
 „ Edmund, K., N 462
 „ Edmund, K. M., Appdx 310
 „ Edward, Mch 324
 „ Edward the Confessor, O 327
 „ Edward, Translation of, Ju.
 281
 „ Edwen, Appdx 297
 „ Edwin, O 292
 „ Eelko Liankaman, Mch. 413
 „ Efflam, N 161, Appdx 297
 „ Egbert, Ap 327, Appdx. 309
 „ Egelwin, Appdx. 318
 „ Egwin, Jan. 160
 „ Egrad, Appdx 167
 „ Emion, Appdx. 180
 „ Elaeth the King, Appdx. 303
 „ Eldad, Appdx. 179
 „ Elesbaan, O 659
 „ Eleutherus, F 350, Au. 34
 SS. Eleutherus and Antua, Ap.
 223
 „ Eleutherius, Dionysius, and
 Rusticus, O 195
 „ Eleutherus and comp., O. 14
 S. Elfyva, My 254
 „ Elfleda, F. 214
 „ Elfleda, Abbess of Rumsey,
 O. 714
 „ Elfleda of Glastonbury, O. 580
 „ Elian Gemiad, Appdx. 170
 SS. Elias and Flavian, Jly. 99
 „ Elias and others, F. 314
 S. Elgus, B. of Noyon, D 2
 „ Elmed, Appdx 258
 „ Elizabeth of Hungary, N. 415
 B Elizabeth of Hungary, My 100
 S. Elizabeth of Schonau, Ju. 252
 SS Elizabeth and Zacharias, N.
 147
 S. Elhdus, Appdx. 259
 B Elmo, Ap 205
 SS Elpidius and comp., N. 344
 S. Elstan, Appdx 208
 SS Elvan and Mydwyn, Jan. 5
 S. Elwyn, O 658
 „ Elzear, S. 402
 SS Emerita and Digna, S. 328
 „ Emetherius and Chelidonius,
 Mch. 44
 S. Emilian, N 347
 SS Emilius and Jeremias, S. 251
 S Emma, Ju 461
 „ Emmeram, S 338
 „ Enda, Mch 376
 „ Engelbert, Abp. of Cologne,
 N 179
 „ Engelmund, Ju. 291
 „ Enghenedl, Appdx. 278
 „ Englat, N 85
 „ Ennodius, Jly 420
 „ Enoder or Cymdr, Appdx
 216
 „ Eogan of Ardstraw, Au 251
 „ Epaphras, Jly 445
 „ Eparchius, Jly 21
 „ Ephraem, Syriac, F 7
 SS Epimachus and Alexander,
 D 156
 „ Epimachus and Gordian, My
 141
 S Epiphanius, My. 164
 Epiphany, The, Jan 82
 SS. Episteme and Galacto, N.
 149
 S. Erasmus, Ju 20
 „ Erastus, Jly. 570
 „ Erban, Appdx 170, 228
 „ Erc, B. of Slane, N. 59
 „ Erfyl, Appdx 248
 „ Erick, My 256
 „ Erkonwold, Ap 375
 „ Erme, Appdx. 264
 „ Ermel, Appdx 264
 „ Ermelund, O. 707
 „ Ermenburga, Appdx. 309
 „ Ermengytha, Appdx 257
 „ Ermenilda, F. 292
 „ Ermine, Ap. 342
 „ Ermmold, Jan. 86
 „ Ernan, Appdx. 161, D. 237
 „ Eskill, Ju 171
 „ Ethbn, O. 484
 „ Ethelbert, F. 406, My. 308
 „ Ethelburga, Jly. 169, O 281
 „ Etheldreda, O 440
 „ Etheldrutha, Au. 19
 „ Etheldwitha, Appdx. 253
 „ Ethelgiva, Appdx. 321
 „ Ethelhard, Appdx. 221

- S. Ethelnoth, Appdx 286
 SS. Ethelred and Ethelbert, O. 438
 S Ethelwin, Appdx. 219
 „ Ethelwold, F. 283, Mch. 441
 „ Ethelwold, B. of Winchester, Au. 8
 „ Etto, Jly. 261
 „ Eubulus, F. 449, Mch 114
 „ Eucher, F. 355
 „ Eucherus, B of Lyons, N 345
 „ Eudocia, Mch. 2
 SS Eudoxus, Zeno, and comp, S 68
 S. Eugenius of Carthage, Jly 310
 SS. Eugraphius and comp., D 125
 S. Eulalia, F 276
 SS Eulalia and Julia, D 124
 „ Eulampius and Eulampia, O. 225
 S. Eulogus, Jan. 312, Mch 218, Jly. 90, S. 189
 „ Euphemia, S. 257
 „ Euphrasia, Mch. 241
 „ Euphrosyne, F 264
 „ Euplius, Au 116
 „ Eupychius, Ap 130, S 96
 „ Eurfyl, Appdx 248
 „ Eurgan, Appdx. 244
 SS. Eusannus and comp, 206
 S Eusebia, Mch. 279, O 703
 „ Eusebius, F. 306
 „ Eusebius, B of Vercelli, D. 191
 „ Eusebius of Cæsarea, Ju 282
 „ Eusebius of Samosata, Ju 285
 SS. Eusebius, Nestabo, and comp, S. 118
 S. Eustace, Mch 498
 „ Eustathius, Jly. 399
 SS. Eustathius and comp., S. 319
 S Eustochum, S 411
 „ Eustorgus, S 292
 „ Euthymius. Jan. 305, Mch 216
 „ Eutropius, Jan. 163, Mch 44, Ap 370
 S. Eutyches, Au. 261
 SS Eutyches and comp., Ap. 199
 S Eutychnus, Pope, D 110
 SS. Eutychnus and comp., O 120
 S. Eval, or Evall, Appdx. 310
 „ Evaristus, Pope, O. 643
 „ Everilda, Jly. 210
 „ Evermar, My 24
 „ Evermund, Ju. 132
 „ Evodius, My. 93
 SS. Ewalds, The two, O. 55
 Exaltation of the Cross, The, S 233
 Expectation of the Confinement of our Lady, D 218
 S. Exuperius, S 410
 S. FABIAN, Jan. 299
 „ Fachnan, Au. 140
 SS. Facundus and Primitivus, N. 562
 „ Failbhe, O. 134
 „ Failbhe, I, Appdx 197
 „ Failbhe the Little, Appdx 194
 „ Fauth, O. 132
 „ Fara, D. 105
 „ Faro, B. of Meaux, O. 698
 SS Faustinus, Beatrix, and Simplicius, Jly. 631
 „ Faustinus and Jovita, F 305
 S. Faustus, N 412
 „ Faustus, B. of Riez, S 413
 SS. Faustus and others of Alexandria, O. 50
 „ Faustus and others of Cordova, O. 321
 S Febroma, Ju 343
 „ Fechin, Jan 310
 „ Fedluid, Au. 106
 SS Felician and Prinus, Ju 87
 „ Felcissimus and Rogatianus, O. 644
 S. Felicitas, Mch 102
 SS Felicitas and her sons, Jly. 251
 S. Felicula, Ju 176
 SS Felinus and Gratian, Ju 1
 S Felix, Jan. 199, Mch. 163, Au. 5, N 159

- S. Felix II., Pope, Jly. 631
 " Felix of Cantalice, My 258
 " Felix of Spalato, My. 253
 " Felix of Sutri, Ju 307
 " Felix of Tubzacene, O 601
 " Felix of Valvis, N. 485
 SS. Felix and Adauctus, Au. 383
 " Felix, Andochius, and Thyrsus, S. 361
 " Felix and comp, Ap. 300, Jly 256
 " Felix and Cyprian, O. 287
 " Felix and Fortunatus, Ju 143
 " Felix and Maurus, Ju 221
 " Felix, Nemesianus, and comp, S 144
 " Felix and Regula, S. 169
 S Ferdinand III., K., My 421
 " Fergna the White, Appdx 188
 " Fergus, N 395
 " Ferreolus, S. 289
 " Ffagan, Appdx. 259
 " Ffinan, Appdx. 322
 " Fflewyn, Appdx. 321
 " Fiacre, Au 384
 SS. Fides, Spes, Charitas, and Sapientia, Au. 4
 S Fidelis, O 696
 " Fidelis of Sigmaringen, My. 332
 " Fidolus, My 216
 " Fiech, O. 290
 " Fillan, Jan 127
 " Fina, Mch 239
 " Fman, F. 325
 " Finan, or Finian, the Leper, Appdx. 196
 Fimbar, S. 377
 SS. Fingar and Piala, Mch 437, Appdx 198
 S. Finian, Appdx. 272
 " Finnian, Mch. 321
 " Finnian, B of Clonard, D. 159
 " Fintan, F 324
 " Fintan Munnu, O 556
 " Firmilian, B. of Cæsarea, O. 686
 " Firminus, S. 4
 S Firminus, Martyr, S 375
 " Flannan, B of Killaloe, D. 221
 " Flavia Domitilla, My 106
 SS. Flavia Domitilla and comp, My 158
 S Flavian, F. 331, D 236
 SS. Flavian and Elias, Jly. 99
 " Flora, and Mary, N. 525
 S Floregus, Jly 8
 " Florentia, Ju. 279, D 1
 " Florentus, O 322
 " Florus, B of Lodeve, N. 65
 " Foillan, O. 721
 " Forannan, Ap. 376
 " Fortchern, F. 321
 " Fortunatus, F 47, O. 353
 SS. Fortunatus and comp, Ap 300
 " Fortunatus and Felix, Ju 143
 " Forty-five Martyrs of Nicopolis, Jly 257
 " Forty Martyrs of Sebaste, Mch 204
 S. Fothadh II., Appdx. 179
 SS Four Martyrs of Gerona, Ju 78
 S Frances of Rome, Mch 185
 " Francis of Assisi, O 68
 " Francis of Girolamo, My 156
 " Francis of Paula, Ap 25
 " Francis of Sales, Jan 443
 " Francis Borgia, O 249
 " Francis Caracciolo, Ju 37
 " Francis Solano, Jly 541
 " Francis Xavier, N 602
 " Frederick, Jly. 437
 " Frederick of Liege, My. 405
 " Fremund, My. 154
 Frideswide, O 484
 " Fridolin, Mch 91
 " Frigidian, Mch. 321
 " Frithbert, Appdx. 323
 " Frithestan, Appdx. 273
 " Frodobert, Jan. 112
 " Fronto, Ap 187
 " Fronto, B. of Perigneux, O. 631
 " Fructuosus, Jan. 312, Ap. 211
 " Frumentus, O. 650

- S. Fulcran, F. 294
 ,, Fulgentius, Jan 10
 ,, Fulk, B. of Toulouse, D 291
 ,, Fulquius, B of Therouanne,
 D. 187
 ,, Fursey, Jan 243
 SS. Fusca and Maura, F. 286
 ,, Fuscianus and comp., D 136
 SS. Fyneana and Findocha, O.
 324
- S. GABINIUS, F. 340
 ,, Gabriel, Archangel, Mch. 312
 SS. Gaiane, Rhupsme, and others,
 S 437
 ,, Galactio and Episteme, N
 149
 S. Gall, Jly. 17, O 419
 ,, Galla, O 125
 ,, Gallgo, Appdx 316
 ,, Gatian, B. of Tours, D. 219
 ,, Gaudentius, Jan 334
 ,, Gaudentius, B of Brescia, O.
 635
 ,, Gelasius, Actor at Heliopolis,
 F. 443
 ,, Gelasius, Boy, F 83
 ,, Gelasius, Pope, N. 487
 SS. Geminianus and Lucia, S.
 259
 S Gemma, Ju. 270
 ,, Genebald of Laon, S 70
 ,, Genes, M. at Arles, Au. 270
 ,, Genes, M. at Rome, Au 267
 ,, Gengulf, My. 151
 ,, Genoveva, Jan. 46
 SS. Gentianus and comp., D. 136
 S. Genulph, Jan. 247
 ,, George, Ap. 301
 ,, George of Amastus, F. 363
 ,, Georgia, F. 306
 ,, Geraint of Gerontius, Appdx.
 260
 ,, Gerald, Ap 74
 ,, Gerald, B. of Beziers, N. 157
 B. Gerard, Ju. 179, My. 187
 S. Gerard, O. 57
 ,, Gerasimus, Mch. 63
 SS. Gerebern and Dymphna, My
 207
- S Geremar, S. 362
 SS Gereon and comp., O 224
 S Gerlach, Jan. 51
 ,, Germame Cousin, Ju 216
 ,, German of Man, Jly 97
 ,, German of Paris, My 412
 SS German and Randoald, F.
 361
 S. Germanicus, Jan. 284
 ,, Germanus of Auxerre, Jly. 681
 ,, Germanus of Constantnople.
 My. 174
 ,, Germoc or Germoe, Appdx
 240
 ,, Germock, O. 658
 ,, Gernad, N 201
 ,, Gerold, Ap. 228
 ,, Gertrude, Mch 306
 ,, Gertrude, N 342
 ,, Gertrude of Hamage, D 70
 ,, Gerulf, S. 326
 SS Gervasius and Protasius, Ju
 256
 ,, Getulus, Cereals, and others,
 Ju. 127
 S Ghislain, O. 211
 ,, Gibrian, My 114
 ,, Gilbert, F. 99
 ,, Gilbert of Auvergne, Ju 67
 ,, Gilbert of Caithness, Ap 10
 SS. Gilbert and Alkmund, S. 109
 S. Gildas, Jan 440
 ,, Giles, S. 8
 ,, Gisthan, Appdx 191
 B. Gizar of Skalholt, My 413
 S. Glodesmd, Jly. 562
 ,, Gluuias or Glywys, Appdx.
 219
 ,, Glyceria, My 181
 ,, Goar, Jly. 154
 ,, Goban, Ju. 280
 ,, Gobrian, N. 346
 ,, Godebertha, Ap 163
 ,, Godeheva, Jly. 160
 ,, Godfrid, B. of Amiens, N.
 203
 ,, Godnck, My 322
 ,, Goeznou, O. 639
 ,, Gofor, Appdx 220
 ,, Golinduc, Jly. 316

- S. Golwen, Jly. 26
 „ Gonsalvo, Jan 142
 SS. Gordian and Epimachus, My
 141
 „ Gordian, Macrobius, and
 comp, S. 185
 S. Gordms, Jan 42
 „ Gorgo, Mch. 212
 „ Gorgonia, D 117
 „ Gorgonus, Mch. 222
 SS. Gorgonius and Dorotheus, S
 131
 B. Gotfried, Jan 194
 S. Gothard of Hildesheim, My.
 73
 „ Gotteschalk, Ju. 73
 „ Gorwst, Appdx. 318
 Ss. Grace and Probus, Appdx. 208
 S. Grata, S 48
 SS Gratia and comp, Au. 226
 „ Gratian and Felinus, Ju. 1
 S Gredifael, Appdx 304
 „ Gregory, Ab. of Einsiedeln,
 N 202
 „ Gregory, B. of Tours, N 381
 „ Gregory II, Pope, F. 293
 „ Gregory III, Pope, N. 579
 „ Gregory VII, Pope, My. 350
 „ Gregory of Langres, Jan 58
 „ Gregory of Nyssa, Mch. 172
 „ Gregory of Spoleto, D. 270
 „ Gregory the Great, Mch. 226
 „ Gregory the Illuminator, S.
 442
 „ Gregory the Wonder-Worker,
 N 375
 „ Gregory Nazianzen, My. 125
 SS. Gregory, Julian, Mary, and
 comp, Au. 107
 S Grumbald, Jly. 197
 „ Grwst, Appdx. 318
 SS Guardian Angels, O. 14
 S Gudula, Jan. 115
 „ Gudwall, Ju. 57
 „ Guido, S. 181
 „ Guinock, Appdx. 211
 „ Gummar, O 284
 „ Gundebert, Ap 364
 „ Gundleus, or Gwynllyw Filwr,
 Appdx. 202
 S. Gumfortis, Au. 235
 SS Gurias and comp, N 334
 S Guron, or Goran, Appdx. 210
 „ Gurwal, Appdx 230
 „ Gurwall, Ju. 56
 „ Guthagon, Jly 97
 „ Guthlac, Ap 163
 „ Gwenael, N. 67
 „ Gwen of Cornwall, Appdx
 282
 „ Gwen of Wales, Appdx 282
 SS Gwendoline and Brothen, O.
 476
 S. Gwenfaen, Appdx. 296
 „ Gwenfyl, Appdx. 288
 „ Gwenog, Appdx. 165
 „ Gwerr, Ap 71
 „ Gwerr, or Guier, Appdx. 207
 „ Gwethenoc, Appdx. 192
 „ Gwodloew, Appdx 211
 „ Gwrnerth, Appdx. 210
 „ Gwryd, Appdx 293
 „ Gwymer, or Wymer, O. 659
 „ Gwynan, Appdx. 322
 SS Gwyn and comp, 287
 S. Gwynhoedl, or Gwynodl,
 Appdx. 159
 „ Gwynlleu, Appdx 288
 „ Gwynno, Appdx. 287
 „ Gwynnog, Appdx 284
 „ Gwynnoro, Appdx. 287
 SS Gwynoc and Aneurin, O. 646
 S. Gwynws, Appdx 322
 „ Gwythian, O. 659
 S HABAKKUK, Jan 285
 „ Hadelin, F. 49
 „ Hallvard, My. 202
 „ Harold Bluetooth, N. 28
 „ Hedda, Jly 169
 „ Hedwig, O. 456
 „ Hegesippus, Ap. 110
 „ Heimerad, Ju 417
 „ Helena, Jly. 698
 „ Helena, Empress, Au. 164
 „ Helcoms, My 407
 „ Helier, Jly. 403
 „ Heliodorus, Jly. 94
 „ Henry, Jan. 245
 „ Henry, Emp., Jly. 370

- S Herculanus, N. 169
 „ Heribert, Mch. 281
 SS Herlembald and Anald, Ju
 389
 S. Hermagoras, Jly. 283
 B Herman Joseph, Ap 116
 S Hermas, My 124
 SS Hermas and comp, Ap. 121
 S. Hermengild, Ap. 183
 „ Hermias, My. 428
 „ Hermione, S 43
 SS Hermogenes and comp, D
 125
 „ Hermylus and Stratonicus,
 Jan. 179
 S. Hero, O 437
 SS Herodian and comp, Ap 121
 S Hervé, Ju 239
 SS Hesperus and Zoe, My 28
 S. Hesychius, Mch. 1, O 51
 „ Hilarion, O 506
 „ Hilarus, Pope, S. 157
 „ Hilary, Jan 182
 „ Hilary of Arles, My. 75
 SS. Hilary and comp, Mch. 271
 S. Hilda, N. 390
 „ Hildegard, Ap 375, S 279
 „ Hildegund, Ap. 254
 „ Hildeutha, Mch. 446
 „ Hildulf, Jly. 278
 „ Hippolytus, B. of Porto, Au
 233
 SS. Hippolytus and Concordia,
 Au 127
 Holy House of Loreto, D. 129
 S. Honestus, F. 313
 „ Honoratus, Jan. 240
 „ Honorina, F. 444
 „ Honorius, Abp of Canterbury.
 S. 464
 „ Hormisdas, M, Au. 99
 „ Hormisdas, Pope, Au. 78
 „ Hrabanus, Maurus, F 91
 „ Hrosnata, Jly. 325
 „ Hubert, B of Liège, N. 72
 „ Hugh of Cluny, Ap. 365
 „ Hugh of Grenoble, Ap. 7
 „ Hugh of Lincoln, Jly. 592,
 N. 395
 B. Hugo, Mch. 502
 S Humbert, Mch 458
 „ Hyacinth, Au 151
 „ Hyacinth of Amastris, Jly. 412
 „ Hyacinth of Cæsarea, Jly. 89
 SS Hyacinth and Protus, S. 166
 S Hyacintha, Jan. 462
 „ Hychan, Appdx 259
 „ Hydroc, Appdx 220
 „ Hyginus, Jan 149
 „ Hymelin, Mch. 210
 „ Hypatius, N. 326
 SS Hypatius and comp, Ju. 250
 S. Hywyn, Appdx. 167
 SS. IA and Breaca, O 657
 „ Ia and others, Au 36
 S Ibar, Ap. 310
 „ Ida, S. 50
 „ Idda of Toggenburg, N. 96
 „ Idloes, Appdx. 271
 „ Iduberga, My. 116
 „ Ignatius, Africa, F. 46
 „ Ignatius, Antioch, F I
 „ Ignatius Azevedo, Jly. 379
 „ Ignatius Loyola, Jly. 708
 „ Ildefonsus, B. of Toledo, D
 306
 „ Illog, Appdx 259
 „ Ilut or Iltyd, Appdx 249
 Immaculate Conception of B V.
 Mary, D. 108
 S. Ina, F. 186
 SS Indract and comp., F 140
 „ Indract and company, Appdx.
 220
 „ Injunosus and Scholastica,
 My. 344
 S Innocent I, Pope, Jly 598
 „ Innocent of Le Mans, Ju 258
 Holy Innocents, D. 311
 Invention of the Cross, My. 56
 S. Irenæus, Mch. 457
 „ Irenæus of Lyons, Ju. 407
 SS Irenæus and Abundius, Au.
 314
 „ Irenæus and Mustiola, Jly.
 91
 S. Irene, O. 499
 „ Irene, Empress, Au. 134
 SS. Irene and comp., Ap. 34

- B. Irmgard, S 51
 SS. Irmna and Adela, D. 274
 S. Isaias, F 314
 " Isberga, My. 320
 " Ischyron, D 235
 " Isidora, My. 10
 " Isidore, Jan. 228, F. 84, My 146
 " Isidore of Seville, Ap 64
 " Ismael, Appdx. 235
 SS. Ismael and others, Ju. 234
 S. Isserninus, Appdx. 316, 318
 " Ita or Ytha, Appdx. 171
 " Ithamar of Rochester, Ju 133
 " Itta, My. 116
 " Ivan, Ju 337
 " Ivo, B. of Chartres, D 241

 S. JACOB of Toul, Ju. 309
 SS. Jacut, Gwenthenoc, and Creurwy, Appdx 192
 S. Lambert, Appdx. 263
 " James, Deacon, Au. 160, O 476
 B. James de la Marca, N 586
 S. James of Nisibus, Jly 351
 " James (Tarantaise), Jan 242
 " James the Great, Jly 546
 " James the Less, My 5
 " James the Penitent, Jan 433
 " James Intercus, N. 566
 SS. James and comp, Ap 371
 " Januarius and comp, Jly. 256, S. 301, O 321
 S. Jarlath, B. of Tuam, D. 305
 " Jason, Ju. 341
 " Jeanne Francoise de Chantal, D 176
 " Jeremias, F. 314
 SS. Jeremias and Emihias, S 251
 S. Jerome, S. 450
 " Jerome Emilian, Jly. 493
 Jesuit Martyrs in Canada, The, Jly. 733
 S. Joachim, Mch. 336
 " Joan of Valois, F. 109
 " Joannicus, N 109
 " Joavan, Mch. 22, Appdx. 188
 " John, B. of Bergamo, O 705
 " John I, Pope, My. 395

 S. John de Britto, F. 112
 " John of Beverley, My 109
 " John of Bridlington, O 248
 " John of Chmon, Ju 388
 " John of Cvita-di-Penne, Mch 329
 " John of Egypt, Mch 484
 " John of God, Mch. 165
 " John of Holar, Ap. 313
 " John of Matha, F 226
 " John of Nepomuk, My 227
 " John of Nicomedia, S 97
 " John of Rome, Ju. 309
 " John of Sagahun, Ju 172
 " John of Therouanne, Jan 415
 " John of the Cross, N 526
 " John of the Goths, Ju 374
 " John of the Grate, F. 26
 " John the Almsgiver, Jan 348
 " John the Baptist, Nativity of, Ju. 323
 " John the Calybite, Jan. 233
 " John the Divine, D 307
 " John the Dwarf, N. 219
 " John the Silentiary, My. 185
 " John Cantius, O 503
 " John Capistran, O. 582
 " John Cassian, Jly 521
 " John Chrysostom, Jan 400
 " John Climacus, Mch. 506
 " John Columbino, Jly 700
 " John Damascene, My 96
 " John Francis Regis, Ju 225
 " John Gualberto, Jly. 290
 " John-Joseph, Mch. 87
 " John Mark, S. 395
 " John William, F. 255
 SS. John, Abundius, and comp, S 261
 " John and Paul, Ju. 366
 S. Jones, Abp. of Novgorod, N 158
 " Jonas the Gardener, F. 263
 SS. Jonas and Barachusius, Mch. 491
 " Josaphat and Barlaam, N. 562
 S. Joseph, Count, Jly. 511
 " Joseph, husband of B. V. Mary, Mch. 327
 " Joseph of Arimathea, Mch. 283

- S Joseph of Cupertino, S. 292
 „ Joseph of Leonissa, F. 111
 „ Joseph the Hymnographer,
 Ap 48
 „ Joseph Barsabas, Jly. 484
 „ Jovita, F 305
 „ Judas, or Quiriacus, My 64
 „ Jude, Ap, O 674
 SS Judith and Salome, Ju. 455
 S. Judoc, D 173
 „ Julia, O 283, My. 332
 SS Julia and Claudius, Jly. 497
 S Julia and Eulalia, D 124
 „ Julian, S 185
 „ Julian, Alevandna, F 422
 „ Julian in Africa, F 395
 „ Julian of Anazarbus, Mch
 273
 „ Julian of Casarea, F. 320
 „ Julian of Le Mans, Jan. 398
 „ Julian Sabas, O 473
 SS. Julian and Caesarus, N. 10
 „ Julian and comp, Au. 107,
 Jan. 121
 S Juliana, F 316, Ap 76
 „ Juliana Falconieri, Ju 267
 „ Julitta, Jly. 679
 SS. Julitta and Cyriac, Ju 219
 S. Julius, My 394, Au. 175
 „ Julius I., Pope, Ap 176
 SS. Julius and Aaron, Appdx. 245,
 Jly 1
 S. Junian, O 417
 „ Jurmin, Appdx. 186
 „ Just, Appdx. 264
 „ Justin, Apologist, Ap. 177
 „ Justina, O 152, Jan. 133
 SS. Justina and Aureus, Ju. 221
 „ Justina and Cyprian, S 386
 S. Justman, Au. 250, Appdx.
 320
 „ Justus, N 564, Appdx. 303
 „ Justus, Abp. of Canterbury,
 N. 232
 „ Justus, Boy, O. 471
 „ Jutwara, or Jutwell, Appdx.
 252
 SS. Juventine and Maximus, Jan
 371
 S. Juventinus, F. 211
 S. KATHERINE of Sweden, Mch.
 421
 „ Katherine Audley, Appdx 314
 „ Kay, Appdx 294
 „ Kea, Appdx. 294
 „ Kellach, My 21
 „ Kenan, Appdx 294, N 153
 „ Kenelm, Jly 427
 „ Keneth, Au 6
 „ Kennera, O 713
 „ Kennocha, Mch 255
 „ Kennotha, or Kevoca, Appdx.
 195
 „ Kenny, O. 278
 „ Kentigern, Jan. 187
 „ Kentigerna, Appdx. 169
 „ Kessog, Mch 208
 „ Kevern, Appdx. 305
 „ Kevin, Ju 27
 „ Keyne, O 178
 „ Kiara, O. 429
 „ Kieran, Appdx 192, Mch. 66
 „ Kieran of Clannacnois, S. 132
 „ Kigwoe, or Kywa, Appdx. 180
 „ Kihan, Jly. 188
 „ Kunegund, Mch. 52
 SS Kyneburga and comp, Mch. 93
 S. Kyneswitha, Mch. 93
 S. LACTEAN, Mch. 331
 „ Ladislas, Ju. 400
 SS Lactus, Donatian, and others,
 S 89
 „ Lætus and Vincent, S. 4
 S. Lambert, S. 274
 „ Landelin, Ju. 212
 „ Landoald, Mch. 333
 „ Landrada, Jly. 191
 SS. Largus and comp., Au. 98
 S Laseran, Ap 224
 „ Launomar, Jan. 287
 „ Laurence, Au 109
 „ Laurence, Cant., F. 39
 „ Laurence Justinian, S. 76,
 Jan. 119
 „ Laurence O'Toole, N 328
 „ Laurence, the Illuminator, F.
 49
 SS. Laurence and Peregrinus, Ju.
 22

- S Laurentinus, F 46
 „ Lazarus, D 204
 „ Lazarus, B of Milan, F. 264
 „ Lazarus, Constantinople, F.
 386
 „ Leander, F. 445
 „ Lebuunus, N. 307
 „ Leo, Archb. of Rouen, Mch.
 19
 „ Leo II, Pope, Ju. 413
 „ Leo III., Pope, Ju. 156
 „ Leo IV., Pope, Jly 428
 „ Leo IX., Ap. 233
 „ Leo the Great, Ap 137
 „ Leobard, Jan. 278
 „ Leocadia, D 115
 „ Leodegar, or Leger, O 19
 „ Leonard of Limoges, N 159
 „ Leonard of Porto-Maurizio,
 N 549
 „ Leonard of Resesby, N 166
 „ Leonore, Appdx 246, Jly. 23
 SS Leontius and comp, Ju. 250
 S Leopold, N. 340
 „ Leodomer, O 15
 „ Leutfried, Ju 290
 „ Levan, O. 658, D. 273
 „ Levan or Levin, Appdx 231
 „ Lewina, Appdx 254
 SS Liberatus, Boniface, and
 comp., Au. 159
 S. Libernus I., B. of Ravenna,
 D 404
 „ Libernus, Pope, S. 351
 „ Liborius, Jly. 521
 „ Licinius, F 292
 „ Lidwyna, Ap 189
 „ Liebert, Jly 324
 „ Lietbert of Cambrai, Ju. 310
 „ Linnæus, F. 367
 „ Linus, Pope, S 349
 „ Lioba, S. 417
 „ Lavinus, N 300
 „ Llechid, Appdx 319
 „ Lleuddad, Appdx. 172
 „ Llibio, Appdx. 187
 „ Llwhaearn, Appdx. 169
 SS. Llywelyn and Gwrnerth,
 Appdx. 210
 S. Lo, S. 337
 S. Lolan, S. 340
 SS Loman and Fortchern, F. 321
 S. Longinus, Mch. 226
 „ Louis, Au 284
 „ Lous, B. of Toulouse, Au
 185
 „ Louis Bertrand, O 213
 „ Louthiern, O. 438
 „ Lubin, Mch. 257
 „ Lubentius, O 322
 SS. Luceja and Aucejas, Ju 342
 „ Lucia and Geminianus, S 259
 S Lucian of Antioch, Jan. 88
 „ Lucian of Beauvais, Jan 99
 SS. Lucian and Marcian, O 644
 „ Lucian and others, Jly 166
 „ Lucilla and Nemesius, O 725
 S Lucina, Ju 462
 „ Lucius, D. 13, F 395, Mch
 55
 SS. Lucius and Ptolemæus, O.
 478
 S. Lucy, D. 168
 „ Ludmilla, S 265
 „ Ludger, Mch 469
 „ Ludwig, Ap 381
 „ Luke, Evan, O 467
 „ Lullus, Abp. of Mainz, O.
 434
 „ Luperculus, Ju. 410
 „ Lupicinus, Mch. 371
 „ Lupus, Jly 635
 „ Lupus, Abp of Sens, S. 5
 „ Lupus of Chalons, Jan 413
 SS. Luxorius, Cisellus, and Came-
 rinus, Au. 221
 S. Lydia, Mch. 482, Au. 24
 S. MABENNA, Appdx. 276
 „ Mabyn, Appdx 276
 „ Macarius, Mch. 208, D 109,
 Ju. 271
 „ Macarius of Antioch, Ap 133
 „ Macarius, Alexandria, Jan 28
 „ Macarius, Egypt, Jan 221
 „ Maccald, or Maughold, Ap
 338
 „ Maccallin, O. 139
 „ Maccarthen, Au. 148
 „ Macedomus, Jan. 362

- SS. Macedonius, Theodulus, and Tatian, S 179
 S. Machan, Appdx. 277
 „ Machar, N. 315
 „ Machraith, Appdx. 161
 „ Machudd, Appdx 305
 „ Maclovius, or Malo, N. 336
 „ Macniss, S 36
 „ Macra, Jan 85, Ju. 146
 „ Macrina, Jan. 202, Jly. 446
 SS. Macrobius, Gordian, and comp., S. 185
 S. Macwoloc, Appdx. 176
 „ Madelberta, S 109
 „ Madern, My 239
 „ Mael, or Mahail, Appdx. 221
 SS. Mael and others, F 178
 S. Maelog, Appdx 326
 „ Maelrubh, Appdx. 215
 „ Maelrubha, Au. 346
 „ Maelrys, Appdx 159
 „ Maen, or Meven, Ju. 288
 „ Maethlu, Appdx. 325
 „ Maglorius, B of Dol, O 616
 „ Magnoald, S. 94
 „ Magnobod, B. of Angers, O 428
 „ Magnus, Ap. 211, Au 176
 „ Maidulf, or Maidulf, Appdx. 213
 „ Majolus, My. 154
 SS. Majoricus and others, D. 69
 S Malachy, Abp of Armagh, N 85
 „ Malchion, O. 695
 „ Malchus, O. 530
 „ Malchus, B. of Lismore, Au. 112
 „ Malo, Appdx 304
 „ Mamertus, My. 150
 „ Mammias, Au 158
 „ Manaccus, Appdx 281
 „ Mansuetus, S. 35, F. 341
 SS. Manuel, Sabiel, and Ismael, Ju 234
 „ Marana and Cyra, Au. 28
 S. Marcella, Appdx. 271, Jan. 466
 „ Marcellina, Jly. 412
 „ Marcellinus, Pope, Ap. 345
 S. Marcellinus of Carthage, Ap. 89
 „ Marcellinus of Embrun, Ap. 251
 SS. Marcellinus and Marcus, Ju 251
 „ Marcellinus and comp., Ju. 19
 S. Marcellus, Jan. 238, S 44, O 719
 „ Marcellus, Bp., Au 137
 „ Marcellus, B of Paris, N. 23
 SS. Marcellus and Apuleus, O 154
 „ Marcellus, Mammæa, and comp., Au 328
 S Marchell, Appdx. 271
 „ Marcian, Jan 134, N. 54
 „ Marciana, Jan 120
 SS. Marcian, Abundius, and comp., S 261
 „ Marcian and Lucian, O 644
 „ Marcian and Nicander, Ju 231
 „ Marcian, Nicander, and comp., Ju 39
 S. Marculf, My. 15
 SS. Marcus and Marcellinus, Ju 251
 S. Mares, Jan. 374
 „ Margaret, Jly. 485, Ju. 136, O 642
 B. Margaret-Mary Alacoque, O. 465
 „ Margaret of Colonna, D. 409
 S. Margaret of Cortona, F. 371
 B. Margaret of Louvain, S. 17
 SS. Marian, James, and comp., Ap. 371
 S. Mariamne, F. 318
 B. Marianna of Jesus, My. 392
 S. Marina, Jly. 424
 S. Marmus, D. 300, Au. 101
 „ Marmus, Deac, S 46
 SS. Marinus and Asterius, Mch. 42
 „ Marinus and comp., Jly. 256
 „ Maris and others, Jan. 285
 S. Marius, B. of Avenches, D. 425
 „ Mark, B. of Jerusalem, O. 564

- S Mark, Evang, Ap 334
 „ Mark of Aethusa, Mch 492
 „ Mark of Lucera, Ju 191
 „ Marnan or Marnock, Appdx
 188
 „ Manoc or Marnan, Appdx.
 283
 „ Marnock, O. 639
 SS Maro and comp, Ap 199
 S. Marra, Jan 285, F 373, Jly.
 611
 „ Martial of Lamoges, Ju 463
 SS Martials and comp, O. 321
 S Maitian, F 289
 „ Martin, B of Tours, N 241
 „ Martin, Pope, N 293
 „ Martin, Ab of Verton, O
 618
 SS Martinian and comp, O 416
 „ Martyrius and comp, My
 418
 „ Martyrs at Alexandria, F
 449
 „ Martyrs at Lichfield, Jan 28
 „ Martyrs at Nicomedia, D 277
 „ Martyrs in Arabia, F 367
 „ Martyrs in Canada, Jly 733
 „ Martyrs in the Thebaid, Jan
 65, Jly 598
 „ Martyrs in the Serapion, Mch
 284
 „ Martyrs of Africa, Ap 73
 „ Martyrs of Alexandria, My.
 181
 „ Martyrs of Ebbecksdorf, F.
 45
 „ Martyrs of Gorkum, Jly 212
 „ Martyrs of Japan, F 141
 „ Martyrs of Nicopolis, Jly 257
 „ Martyrs of Nismes, My 312
 „ Martyrs of Sandomir, Ju 21
 „ Martyrs of Saragossa, Ap
 208
 „ Martyrs of Sebaste, Mch. 256
 „ Martyrs under Alexander,
 Mch. 21
 „ Martyrs under Nero, Mch.
 256, Ju. 334
 „ Martyrs under the Lombards,
 Mch. 23
 S Marrianus, O 658
 BV Mary, Immaculate Con-
 ception of the, D 108
 BV Mary, Presentation of,
 N 486
 BV Mary, Visitation of the,
 Jly 32
 S. Mary, BV, Purification of,
 F 34
 B Mary d'Oignies, Ju 319
 S Mary of Rome, N 18
 „ Mary of the Snows, Au 62
 „ Mary, the Mother of Mark,
 Ju 454
 „ Mary the Sorrowful, Ju 254
 „ Mary, wife of Cleopas, Ap
 124
 „ Mary Magdalen, Jly 503, 611
 „ Mary Magdalen of Pazzi, My
 381
 SS Mary and Flora, N. 525
 „ Mary and comp, Au 107
 „ Mary of Egypt and Zosimus,
 Ap 15
 S Materiana, Appdx 210
 „ Maternus, B. of Trèves, S
 230
 „ Mathernus or Madron, Appdx.
 222
 „ Mathilda, Mch 260
 „ Matrona, Mch. 268
 „ Matthew, Ap Evang, S 323
 „ Matthew of Beauvais, Mch.
 488
 „ Matthias, Ap. F 393
 „ Maudez, N 402, Appdx. 306
 „ Maughan, Appdx 277
 „ Maura, F 286
 SS Maura and Baya, N 60
 „ Maura and Bridget, Jly 306
 „ Maurice and comp., F. 358,
 S 329
 S Maurilius, S. 186
 „ Maurontius, My 78
 „ Maurus, Jan. 234
 SS. Maurus and Felix, Ju. 221
 S Mawes, Appdx 306
 „ Mawgan or Meugant, Appdx.
 277
 „ Maxwellend, N. 318

- S. Maventa, N. 461
 ,, Maxentius, Ju 371
 ,, Maxima of Nicomedia, Mch 222
 ,, Maxima of Sermium, Mch 467
 SS. Maxima, Donatilla, and Secunda, Jly 678
 S. Maximian, F. 369, O 54
 ,, Maximinus, Ab of Miscy, D 198
 ,, Maximus, F. 329, Jan. 371
 ,, Maximus, B of Mixy, D 198
 ,, Maximus, B of Riez, N 569
 ,, Maximus of Aix, Ju 77
 ,, Maximus of Ephesus, Ap 369
 ,, Maximus of Jerusalem, My 74
 ,, Maximus of Rome, N. 412
 ,, Maximus of Turin, Ju. 353
 SS Maximus and Olympias, Ap 200
 ,, Maximus and Venerandus, My. 343
 ,, Maximus, Quntilian, and comp, Ap 181
 ,, Maximus, Theodotus, and Asclepiodotus, S. 247
 S. Mazota, D 240
 ,, Mechell, Appdx 305
 ,, Medana, Appdx 308
 ,, Medard of Noyon, Ju 79
 SS Medran and Odran, Jly. 168
 S. Meigan, Appdx. 277
 ,, Meinrad, Jan. 321
 ,, Meinulf, O. 127
 ,, Merion, Appdx 179
 ,, Melangell or Monacella, Appdx. 225
 ,, Melania the Younger, D. 417
 ,, Melanias, Appdx. 296, Jan 85
 ,, Melas, Jan 239
 ,, Melchades, Pope, D. 126
 ,, Melchu, F 178
 ,, Meldan, F. 193
 ,, Meletus, D 28, F 278
 ,, Mellitus, Ap. 326
 ,, Melor, Appdx 162, Jan 44
 Memorial of the Crucifixion, Mch 454
- SS Memorius and comp , S. 103
 ,, Menas, Hermogenes, and Eugraphius, D. 125
 S Mengold, F. 220
 ,, Menna, O 52
 ,, Mennas, N 239
 ,, Mennas, Patr of Constanti- nople, Au 271
 SS Menodora, Matrodora, Nym- phodora, S. 145
 S Mercurius, N 540
 ,, Merewenna, V. Rumsey, Appdx. 221
 ,, Merewenna, V. Marham Church, Appdx. 263
 ,, Meriadoc, Appdx. 231
 ,, Merrn or Meilyn, Appdx 167
 ,, Methodius, S. 291, Mch 176
 ,, Methodius, Patr. of Constanti- nople, Ju 204
 ,, Metrophanes, Ju. 33
 ,, Mengant, Appdx 277
 ,, Mevan, Appdx 238
 SS. Michael and All Angels, S. 428
 S Michael, Appantion of, My. 115
 ,, Milburgh, F 382
 ,, Mildgytha, Jan. 273
 ,, Mildred, F 354, Jly. 317
 SS Milles and comp , N. 230
 S. Minver or Menefreda, Appdx. 314
 ,, Mnason, Jly 282
 ,, Mochoemog, Mch. 245
 ,, Mochua or Cronan, Jan. 20
 ,, Mochua or Cuan, Jan 19
 ,, Mochteus of Louth, Au. 182
 ,, Mochuda of Lismore, My 196
 ,, Modan, F. 91
 ,, Moderan, or Moran, O. 573
 ,, Modesta, N 108
 SS Modestus and others, Ju. 207
 S Modoc, S 108
 ,, Modomnoc, F. 291
 ,, Modwenna, Jly 150
 ,, Molng of Ferns, Ju 249
 ,, Moloc, or Mo-luoch, Appdx. 240
 ,, Molua of Clonfert, Au 37

- S Monan, Mch 18
 „ Monan or Momen, Appdx.
 188
 „ Monegunda, Jly. 38
 „ Monessa, S. 47
 „ Monica, My 67 ✓
 SS Montanus and comp, F. 395
 „ Montanus and Maxima, Mch.
 467
 S Monynna, Jly 149
 „ Morwenna, Jly 146
 „ Mosentius, Jan 163
 SS Moses and others, F. 192
 S Moses of Syria, F. 376
 „ Moyses, D 219
 „ Moyses the Ethiopian, Au
 348
 „ Mummolin, O 430
 „ Mun, F 178
 „ Muran, Mch 238
 „ Murdach, O. 130
 „ Muredach, Au. 118
 „ Musa, Ap. 24
 SS. Mustiola and Irenæus, Jly 91

 SS NABOR and comp, Jly 256
 Name of Jesus, The, Au 82
 SS Narses and comp, N 460
 S. Narcissus, Mch. 313
 „ Narcissus, B. of Jerusalem,
 O. 701
 SS. Narcissus and comp, O 724
 „ Natalia, Adrian, and comp,
 S 113
 „ Natalia or Sabagotha and
 comp, Jly. 588
 S Nathy, Au. 107
 Nativity of our Lord, D 276
 Nativity of S. John the Baptist,
 Ju 323
 Nativity of the B Virgin, S 110
 SS. Nazarius and Celsus, Jly. 593
 S Nectan, Appdx 238
 SS. Nemesianus, Felix and comp
 S 144
 S Nemesion, D. 223
 SS. Nemesius and Lucilla, O. 725
 S. Nennocha, Ju. 36
 „ Neot, Jly. 697
 SS. Nercus and comp., My. 158

 SS. Nestabo, Eusebius, and comp,
 S. 118
 S. Nestor, F 430
 SS. Nestor, Eusebius, and comp,
 S 118
 S. Nicander, Mch 267
 SS. Nicander and Marcian, Ju
 231
 „ Nicander, Marcian, and comp,
 Ju 39
 S. Nicanor, Jan 133
 SS Nicasius and comp, O 258
 „ Nicasius and Eutopia, D 185
 S. Nicephorus, F. 233, Mch 249
 SS Niceta and Aquilina, Jly 526
 S. Nicetas, Ap. 39, O 135
 „ Nicetas of Nicomedia, S 176
 „ Nicetas the Goth, S 248
 „ Nicetius, B of Trèves, D 61
 B. Nicholas von der Flue, Mch.
 421
 S. Nicolas, F. 92
 „ Nicolas, B of Myra, D 64
 „ Nicolas I, Pope, N 319
 „ Nicolas Tolentini, S 160
 „ Nicomede, S 246
 SS Nicrostratus and others, Jly
 167
 S Nidan, Appdx 278
 „ Nilus, S 389, N 290
 „ Niman, S. 262
 „ Nithard, F 56
 „ Nivard, Abp. of Rheims, S 8
 „ Non or Nonnita, Appdx. 189
 „ Nonnosus, S. 13
 „ Norbert of Magdeburg, Ju. 58
 „ Norhburga, S. 240
 „ Nothelm, Appdx 282
 „ Nothelm, Abp. of Canterbury,
 O 449
 B Notker Balbulus, Ap 95
 S. Novatus, Ju 269
 „ Noyala, Jly. 140
 SS. Numilo and Alodia, O. 575
 S Nwython or Noethan, Appdx
 283
 SS Nymphas and Eubulus, F
 449
 „ Nymphodora, Menodora, and
 Metrodora, S. 145

- S ODA, O. 578
 Ven Ode, Ap 252
 S Odhran, O. 668
 „ Odiha, D 174
 „ Odilo, Jan 20
 „ Odo, N 404
 „ Odo, Abp. of Canterbury,
 Jly III
 „ Odo of Cambrai, Ju 260
 „ Odran, F 341
 SS Odran and Medran, Jly 168
 S Olaf, Jly 636
 „ Olcan, F 349
 SS Olympas and Tertius, N 225
 S Olympias, D 206
 SS Olympias and Maximus, Ap
 200
 S Omer, S. 135
 SS Onesiphorus and Porphyry,
 S 87
 S Onisimus, F 312
 S Onuphrus, Ju 150
 „ Optatus, Ju. 34
 B Ordonco, Jan 211
 S Oriens, My 14
 „ Ornga, Jan 146
 „ Osmund, B. of Salisbury, D.
 48
 „ Oswald, King, Au. 63
 „ Oswald, York, F. 455
 „ Oswin, Au 192
 „ Osyth, O 161
 „ Otto, B of Bamberg, Jly 44
 „ Oudoc, B of Llandaff, Jly 39
 „ Ouen, B of Rouen, Au. 263
 Our Lady of Hal, Jly. 275
 Our Lady of Mount Carmel, Jly.
 407
 „ Owen, Mch. 57

 S PABO POST PRYDAIN, Appdx
 302
 „ Pacian, Mch. 172
 „ Pachomius, My 192
 „ Padarn, Ap 200, Appdx 289
 „ Palæmon, Jan. 149
 „ Palladius, O. 156, Jly. 143,
 Jan. 417
 „ Pambo, Jly 5
 SS. Pamphilus and others, Ju 2

 S. Pancharius, Mch 328
 „ Pancras, Ap 33, My 159
 „ Pandwyna, Appdx 268
 SS Pansemne and Theophanes,
 Ju 130
 S Pantaleon, Jly. 585
 „ Pantalus, O 255
 „ Pantænnis, Jly 167
 „ Papas, Mch 273
 „ Paphnutus, S 169
 SS Paphnutus and comp, S 362
 S Papias, F 366
 „ Pappian, Ju 412
 „ Papulus, N. 65
 „ Parthenius, F 191
 „ Paschal Baylon, My 242
 „ Paschal I., Pope, My 199
 SS Paschrates and Valencio, My
 342
 S Pastor, Jly 571
 SS. Paternuth and comp, Jly 207
 S Patiens, Jan 100
 „ Patrician, Appdx 316
 „ Patrick, Mch. 285
 SS. Patrobas and Philologus, N
 106
 S Patroclus, Jan. 314
 „ Paul, Jan. 215
 „ Paul, Apostle, Ju. 432
 „ Paul, B. of Léon, Appdx 195
 „ Paul, B. of Skalholt, N. 413
 „ Paul I., Pope, Ju. 416
 „ Paul of Constantinople, Ju
 69
 „ Paul of Cyprus, Mch 311
 „ Paul of Leon, Mch. 223
 „ Paul of Narbonne, Mch 406
 „ Paul of Verdun, F. 213
 „ Paul of the Cross, N. 369
 „ Paul the New, Jly. 193
 „ Paul the Simple, Mch 114
 SS. Paul and comp, Jan 277,
 My. 205
 „ Paul, Thea, and Valentina,
 Jly. 561
 S. Paula, F 348, Jan. 384
 „ Paulinus, Jan. 436, Appdx.
 311
 „ Paulinus of Nola, Ju. 304
 „ Paulinus of York, O. 230

- S Paulinus of Trevès, Au 387
 SS. Paulinus and comp, Jly 285
 S Pablig or Publicus, Appdx.
 248
 " Pega, Jan. 118
 " Perthian, Appdx 176
 " Pelagia, O. 169, Ju 89, My.
 66
 " Pelagius, Ju. 377
 Penitent Thief, The, Mch. 456
 S Pepin, F. 360
 " Perpetua, N. 105
 SS Perpetua and comp, Mch 102
 " Peregrinus and Laurence, Ju
 22
 " Peregrinus and others, Jly. 166
 S Peter, Apostle, Ju 419
 " Peter ad Vincula, Au 1
 " Peter of Alcantara, O 487
 " Peter of Alexandria, N 544
 " Peter of Aste, Ju. 485
 " Peter of Canterbury, Jan 86
 B Peter of Castlenau, Mch 74
 " Peter of Kieff, Au 264
 B. Peter of Luxemburg, Jly. 85
 S Peter of Sebaste, Jan 125
 " Peter of Tarentaise, My 117
 " Peter the Spaniard, Mch. 221
 B. Peter the Venerable, D 280
 S. Peter Balsam, Jan. 39
 " Peter Cambian, F. 45
 " Peter Celestine, My 288
 " Peter Chrysologus, D 11
 " Peter Damiani, F 387
 B. Peter Gonzalez, Ap 205
 S. Peter Martyr, Ap. 366
 " Peter Nolasco, Jan 470
 " Peter Paschal, D. 71
 SS. Peter and comp, My. 205
 " Peter and comp. of Carthage,
 Mch. 256
 " Peter and comp of Nicomedia,
 Mch 222
 " Peter, Walabons, and comp,
 Ju 72
 S Peter's Chair, Jan. 275
 " Peter's Chair at Antioch, F.
 365
 " Perpetua, N. 105
 " Petrock, Ju 35

 S. Petronilla, My. 427
 " Peulin, Appdx 311
 " Pharaudis, Jan 60
 SS Phileas and others, F. 80
 " Philemon and Apollonius,
 Mch. 156
 " Philemon and Appia, N 501
 " Philetus and comp, Mch. 428
 S. Philip, S. 184
 " Philip, Ap, My. 1
 " Philip of Agyra, My 161
 " Philip of Tralles, Ju. 55
 " Philip Beniti, Au 252
 " Philip Neri, My. 391
 SS Philip of Heraclea and comp,
 O 565
 S. Philogonius, B. of Antioch,
 D. 225
 SS. Philologus and Patrobas, N
 106
 S Philomena, Jly. 128, Au 111
 SS Philomilla and Zenas, O 257
 " Phlegon and comp, Ap 121
 S Phocas, Mch 63, Jly 320
 " Phocas the Gardeuer, S. 327
 " Phoebe, S. 34
 " Photinus, F 358
 SS Photus and Anicetus, Au. 115
 S. Piala, Mch 437
 " Piatu, O. 1
 " Pienus, N. 106
 " Pinitus, O. 223
 SS. Pionius and comp., F. 5
 S. Prior, Ju 235
 " Piran or Kieran, Mch. 66
 " Pirminus, N. 83
 " Pius V, Pope, My 80
 SS Placidus and comp, O 120
 " Placidus and Sigisbert, Jly.
 280
 S. Plato, Jly. 510, Ap. 69
 " Plechelm, Jly. 358
 " Plegmund, Appdx 258
 SS Plutach, Potamæna, and
 others, Ju 410
 S Poemen, Au. 330
 " Polycarp, Jan. 378
 " Polychronus, B M., F. 319
 " Polychronius, H, F. 376
 " Polyuctus, F. 287

- S Pontianus, Pope, N 411
 „ Pontus, My 188
 „ Poppo, Jan 375
 SS Porcarius and comp, Au 119
 S Porphyrius, F. 434
 SS Porphyry and Onesiphorus, S 87
 „ Potamæna and others, Ju 410
 S. Potamæna the Younger, Ju 68
 SS Pothinus and others, Ju 7
 S. Præjectus, Jan 375
 „ Prætextatus, F 402
 „ Praxedix, Jly 496
 Presentation of the B. V. Mary, N 486
 S Præmianus, F. 376
 SS. Primitivus and Facundus, N 564
 S Primus, Jan. 44
 SS. Primus and Felician, Ju 87
 S. Principius, B. of Soissons, S. 376
 „ Prisca, Jan 276
 „ Priscilla, Jan 238
 „ Priscus, S 1
 SS. Probus and comp, O. 260
 „ Probus and Grace, Appdx 208
 „ Processus and Martinian, Jly. 34
 S. Prochorus, Ap. 130
 „ Proclus, B. of Constantinople, O. 605
 „ Procopius of Cæsarea, Jly 184
 „ Procopius of Prague, Jly. 123
 „ Proculus, Mch. 435
 SS Prosdocæ and comp, O. 63
 S Prosdichimus, N. 168
 „ Prosper of Aquitain, Ju 353
 „ Prosper of Reggio, Ju. 358
 „ Proterius, F 451
 SS. Protus and Hyacinth, S. 166
 S Prudentius, Ap. 362
 SS. Ptolemæus and Lucius, O. 478
 „ Pudens and Pudentiana, My 262
 S Pulcherna, Empss, S. 148
 Purification of B. V. Mary, F. 34
 S QUADRATUS, My. 383
 „ Quartus, N 64
 SS Quatuor Coronati, N 185
 S. Quintin, O 725
 „ Quintin of Tours, O 66
 „ Quntihan, Ap 181
 „ Quiriacus, My 64
 SS Quiriacus, Censurinus, and comp, S 67
 S. Quirinus, Ju 30
 „ Quirinus of Rome, Mch 456
 „ Quinus the Tribune, Mch. 504
 SS Quinnus and comp, O. 258
 S Quiteria, My 333
 „ Quodvultdens, O. 645
 S RADBOD, B. of Utrecht, N 591
 „ Radegund, Queen, Au 130
 „ Radegund, V., Au 136
 „ Ragnbert, Ju. 178
 „ Ragnulf, Jly 323
 „ Randoald, F. 361
 „ Raymund, Jan. 357
 B Raymund Lull, Ju 489
 S Raymund Nonnatus, Au 401
 „ Raymund of Fitero, F 29
 „ Regina, S 101, Jly 31
 „ Reginswinda, Jly. 359
 „ Regula, S. 169
 „ Regulus, O 454, Mch. 504
 „ Remacle, S. 38
 „ Rembert, F 98
 „ Remigius, B. of Rheims, O. 2
 „ Renovatus, Mch 515
 „ Reolus, N. 542
 SS. Respicus and Trypho, N 277
 S Restituta, My 238
 „ Reynildis or Ramilda, Jly. 406
 „ Rhais, S 70
 „ Rhediw, Appdx 303
 „ Rhian, Appdx. 194
 SS. Rhipsime, Gauane, and others, S. 437
 „ Rhuddlad, Appdx. 271
 „ Rhwydrys, Appdx. 287
 „ Richard, F. 194
 „ Richard of Chuchester, Ap
 „ Richard Rolle, Appdx. 277

- S Richarius, Ap 352
 ,, Rictrudis, My 170
 ,, Rigobert, Jan 61
 ,, Roch, F. 178, Appdx. 182
 ,, Roch, Au. 155
 ,, Robert, Ju 76, Appdx. 202
 ,, Robert of Arbrissel, F 426
 ,, Robert of Molesme, Ap 366
 ,, Robert Knaresborough, S. 364
 SS Rogatianus and Felicissimus,
 O. 644
 S. Rolenda, My 187
 ,, Romana, O. 51
 ,, Romanus, Au. 106, N. 401,
 F. 452
 ,, Romanus, B of Rouen, O 577
 SS Romanus and David, S. 75
 S. Romaric, D 110
 ,, Romuald, F 194
 ,, Romula, Jly 524
 ,, Romulus, S 67, N. 152
 SS. Romulus and comp, Jly. 131
 S. Ronald, Au 215
 ,, Ronan, Appdx. 180, Ju. 4
 ,, Rosa, S 57
 ,, Rosalia, S 53
 ,, Rose of Lima, Au. 316
 ,, Ruadan, Ap. 202
 SS Ruderick and Salomon, Mch.
 254
 S Rudesind, Mch. 19
 ,, Rudolf, Ap. 221
 SS. Ruffinus and Valerius, Ju 190
 ,, Rufin and Wulfhad, Jly. 531
 ,, Rufina and Secunda, Jly. 254
 ,, Rufus and Zosimus, D. 219
 S Rumbold, Jly. 27
 ,, Rumon, Jan 57
 ,, Rumon, Roman, or Ruan,
 Appdx. 165
 ,, Rumwold, Appdx 209
 ,, Rusticus, B. of Narbonne, O.
 645
 SS. Rusticus and comp, O. 195
 S Rutilius, Au. 18
 ,, Rychwyn, Appdx 233
 SS. SABAGOTHA, Anrehus, and
 comp, Jly. 588
 S. Sabas, D. 53
 S Sabas the Goth, Ap 176
 SS Sabiel and others, Ju 234
 ,, Sabina and comp, O 649
 S Sabine, F. 241, Jan 273
 SS Sabunan and Sabina, Jan 439
 ,, Sabinus and others, D 405
 S Sadwrn Farchog, Appdx. 317
 ,, Salaberga, S. 339
 ,, Salome, O 562
 SS. Salome and Judith, Ju. 455
 S Salomon, Mch. 254
 ,, Salaun, N 40
 ,, Salvius, Ju 375, S. 158, Jan
 160
 SS Samonas and comp, N. 334
 S Samson, Appdx 254
 ,, Samson, B of Dol, Jly 602
 ,, Sampson Xenodochus, Ju 387
 SS Sanctianus, Augustinus, and
 Beata, S 89
 ,, Sapientia and comp, Au 4
 S Sara, Jly 305
 SS. Saturian and comp, O. 416
 S Saturninus, F 259, N. 589
 ,, Satyrus, S 273
 S Satyrus and others, Jan 163
 S. Savin, O 203
 ,, Sawyl Benuchel, Appdx 172
 ,, Schetzelo, Au. 81
 ,, Scholastica, F 250
 SS. Scholastica and Injuriosus,
 My 344
 S. Scothin, Appdx 161
 SS Scubiculus and comp, O. 258
 S Sebaldus, Au. 183
 ,, Sebastian, Jan 300, F. 212
 ,, Sebbi, Au 380
 SS Secunda and Rufina, Jly 254
 ,, Secunda or Septima and
 comp, Jly 678
 S Secundinus, Appdx 316
 ,, Secundinus, B in Meath, N.
 578
 SS Secundinus and Castus, Jly. 3
 S Secundus, Mch. 503
 SS Secundus and comp., My 319
 S Seniol, Appdx 162
 ,, Sempert, O. 326
 ,, Senan, Ap. 364, O 658,
 Appdx 194

- S. Senan of Iniscathay, Mch 159
 ,, Sennan or Senanus, Appdx 233
- SS Sennan and Abdon, Jly 677
 ,, Separation of the Apostles, Jly 347
- B. Seraphina, S 127
- S. Serapion, B of Antioch, O. 717
 ,, Serenus, F 374, O 16
 ,, Serf or Servan, Jly 9
 ,, Sergius, F. 402
 ,, Sergius I, Pope, S 137
 ,, Sergius, Ab, S 381
- SS Sergius and Bacchus, O 155
- S. Servatus of Tongres, My 183
 ,, Serverian, S. 132
 ,, Servulus, D 239
 ,, Sethrida, Jan 138
- Seven Sleepers, The, Jly 575
- S. Severinus, Jan 101
 ,, Severus, N. 164, Ap. 374
 ,, Severus (Avranches), F 23
 ,, Severus (Ravenna), F. 12
 ,, Severus (Valeria), F. 306
 ,, Sexburga, Jly. 158
 ,, Sezm, Mch 90
 ,, Sidonius Apollinaris, Au. 244
 ,, Sidronius, Jly 277
 ,, Sidwell or Sativola, Appdx 258
 ,, Sigebert, O 712, F 24
 ,, Sigfrid, Appdx. 257
 ,, Sigfried, F. 310
- SS Sigisbert and Placidus, Jly 280
- S. Sigismund, My. 17
 ,, Silas, Jly 304
 ,, Silvester, Jan. 36
 ,, Simeon, F. 328
 ,, Simeon of Ctesiphon, Ap. 260
 ,, Simeon the Old, Jan. 383
 ,, Simeon Metaphrastes, N 574
 ,, Simeon, Prophet, O 164
 ,, Simeon Salus, Jly 26
 ,, Simeon Stylites, Jan 72
 ,, Simon, Ap, O 671
 ,, Simon of Trent, Mch 447
 ,, Simon Stock, My 226
- S. Simplicius, Mch. 22
 ,, Simplicius of Autun, Ju 336
- SS Simplicius, Bertrix, and Faushinus, Jly 631
 ,, Sina and comp, N. 230
 ,, Sisinnius and comp My 418
- S. Sisoës, Jly. 140
 ,, Sixtus, Mch 489
 ,, Sixtus, Pope, Ap. 89
 ,, Sixtus II., Pope, Au. 75
- SS. Smaragdus and comp, Au 98
 ,, Socrates and Stephen, S 272
- S Solanga, My. 145
 ,, Solma, O 437
 ,, Solomon or Selyf, Appdx 421
 ,, Solus, D 20
 ,, Sophronius, Mch. 215
- SS Sosipater and Jason, Ju 341
- S Sosthenes, N 577
 ,, Soteris, F. 248
 ,, Sozon, S 98
 ,, Sperandea, S 174
- SS Speratus and comp, Jly 409
- S Spes, Mch 489
- SS. Spes and comp, Au 4
 ,, Speusippus and others, Jan 246
- S. Speridion, D. 180
 ,, Stachys, O 724
 ,, Stanislas Kotska, N. 322
 ,, Stanislaus of Cracow, My. 110
 ,, Stephen, D 296
 ,, Stephen, K, S. 19
 ,, Stephen I, Pope, Au 16
 ,, Stephen of Grandmout, F. 224
 ,, Stephen of Servia, N 287
 ,, Stephen the Younger, N 583
 ,, Stephen Harding, Ap 220
- SS. Stephen and comp., Jly. 125
- S Stinan, Appdx 320
 ,, Sturm, D. 208
 ,, Sulen, N. 195
 ,, Sulen or Sulm, Appdx 270
 ,, Sulpicius Severus, Jan. 442
 ,, Sunnfa, Jly 195
 ,, Sura, F. 252
 ,, Susanna, S. 320, F 246, Jan. 278, Au. 114

- S Swibert the Elder, Mch 16
 ,, Swithun, Jly 40
 ,, Sylvanus of Gaza, My. 66
 ,, Sylvester, Pope, Ju 271
 ,, Sylvester, Pope, D 412
 ,, Symeon, Jly 571
 ,, Symmachus, Jly. 448
 ,, Symphorian, F 451, Au 230
 SS. Symphorosa and her sons, Jly 432
 S Syncletica, Jan 67
 ,, Syntyche, Jly 510
- S. TALARICAN, O. 721, Appdx 286
 ,, Tancha, O. 247
 ,, Tanco, F 317
 ,, Tanwg, Appdx. 280
 SS. Tarachus and comp., O. 260
 S Taraghta, F. 236
 ,, Tarasius, F. 416
 ,, Tarsilla, D 272
 ,, Tathan or Tathæus, Appdx. 324
 ,, Tatian, Mch 271
 SS Tatian, Macedonius and Theodulus, S 179
 S Tatwin, Abp of Canterbury, Jly 680
 ,, Tecwyn, or Tegwyn, Appdx 274
 ,, Tegla, or Theckla, Appdx. 229
 ,, Teilo, Appdx 181, F 238
 ,, Telemachus, Jan 7
 ,, Telesphorus, Jan 65
 ,, Tenenan, Appdx 253
 SS Ten Thousand Martyrs, Ju. 299
 S Terman, or Torannan, Appdx 233
 SS Tertius and Olympus, N. 225
 S. Tetricus, Mch 322
 ,, Teyrnog, or Tyrnog, Appdx. 207
 ,, Thaddæus, Disc., O 679
 ,, Thais, O. 167
 SS. Thalassius and Limnæus, F. 367
 S. Thalelæus, F. 444
- SS. Thallelæus and comp., My. 307
 S Tharsicius, Au. 143
 SS Thea, Valentina, and Paul, Jly 561
 S Thecla, O. 357, Jan. 278, S. 350
 SS Thecla and Justina, Jan 133
 ,, Thecla and comp., Au 179
 S Thenew, Jly 433
 ,, Theobald, Ju 486
 ,, Theodard, S. 159, My 25
 ,, Theodehilda, Ju 413
 ,, Theodora, Empress, F 275
 ,, Theodora of Alexandria, S 172
 ,, Theodora of Rome, Ap 1
 SS Theodora and Didymus, Ap. 359
 S Theodore, Jly 98
 ,, Theodore, Abp of Canterbury, S 303
 ,, Theodore of Amasea, N 216
 ,, Theodore of Apamea, F 358
 ,, Theodore of Hieraclæa, F. 190
 ,, Theodore of the Studium, N. 262
 ,, Theonic, Jly 11, Jan 414
 ,, Theodosia, Ap 14, My 420
 ,, Theodosius, Jan. 151
 ,, Theodota, Au 18
 ,, Theodotus, B. of Laodicea, N. 48
 SS. Theodotus and comp., My. 245
 ,, Theodotus, Maximus, and Aspidotus, S. 247
 S. Theodulus the Stylite, My. 409
 SS Theodulus and Agathopus, Ap 61
 ,, Theodulus and comp., Jan 202
 ,, Theodulus and Julian, F 320
 ,, Theodulus, Macedonius, and Tatian, S 179
 ,, Theognis and comp., Jan 44
 S. Theonestus, O 720
 ,, Theophanes, S 130
 SS Theophanes and Pansemne, Ju. 130
 S. Theophilus, Pentent, F. 88

- S. Theophilus of Antioch, O 320
 ,, Theophilus the Younger, Jly. 517
 ,, Theorigatha, Jan 397
 ,, Theotimus, Ap. 251
 ,, Theresa, O 358
 ,, Thomas, Ap, D 226
 ,, Thomas à Becket, Appdx. 326, D 325
 B. Thomas of Lancaster, Mch. 414
 S. Thomas of Villanova, S. 341
 ,, Thomas Aquinas, Mch. 116
 ,, Thomas Cantilupe, O 31
 ,, Thorlac, B. of Skalholt, D. 262
 SS. Three Soldiers, Jly 38
 ,, Thyrsus, Andochius, and Felix, S 361
 ,, Thyrsus and comp., Jan. 416
 ,, Thyrsus and others, O 62
 S Tibba, Mch 93
 SS. Tiburtius and Chromatius, Au. 113
 S Tighernach, Ap 62
 SS. Tigris and Eutropius, Jan 163
 ,, Timolaus and comp, Mch. 444
 S. Timothy, Jan. 359
 SS. Timothy and Apollinaris, Au 243
 ,, Timothy and Maura, My. 55
 ,, Timothy, Thecla, and Agapius, Au. 179
 S. Titus, Jan 53
 ,, Torpes, My. 237
 SS. Torquatus and comp., My. 204
 S Tranquillinus, Jly. 136
 Transfiguration of our Lord, The, Au. 75
 Translation of S. Cuthbert, S. 50
 Translation of S. Edward, Ju 281
 Translation of the Holy House to Loreto, D 129
 S. Tresan, F. 192
 ,, Triduana, O. 180
 ,, Trillo, Appdx 234
 ,, Trojanus, N. 598
 ,, Trophuma, Jly. 129
 ,, Trophimus, D 321
 S Trudo, N 511
 ,, Trudpert, Ap. 351
 ,, Trumwin, B. of the Picts, D. 12
 SS. Tryphena and Tryphosa, N. 226
 ,, Trypho and Respicus, N 227
 S. Tryphonia, O. 471
 ,, Tuda, Appdx. 183
 ,, Tudglyd, Appdx 228
 ,, Tudno, Appdx 230
 ,, Tudur, Appdx 281
 ,, Tudy, Appdx 274
 ,, Tugdual, N 599, Appdx 318
 ,, Turgot, Appdx. 206
 ,, Turbius, Ap. 210
 SS. Twelve Brethren, S. 2
 ,, Twenty Monks at S Sabas, Mch 365
 ,, Two Ewalds, O. 55
 S Twrog, Appdx. 243
 ,, Tybie, Appdx. 176
 ,, Tydecho, Appdx 322
 ,, Tydfyl, Appdx 268
 ,, Tyfaelog, Appdx 187
 ,, Tyfei, Appdx 202
 ,, Tyfrydog, Appdx. 160
 ,, Tygris, Ju. 359
 ,, Tylo, Jan. 94
 SS Tyrannio and comp., F. 346
 S Tyssul, Appdx 177
 S. UBALD, My. 223
 ,, Ulched, Appdx. 168
 ,, Ulphia, Jan. 468
 ,, Ulpian, Ap 38
 ,, Ulric, Jly 116
 ,, Uni, O 658
 ,, Urban I., Pope, My 341
 SS Urban and comp., O. 724
 S Urbicus, Ap 38
 ,, Ust, Appdx. 264
 SS Ursula and Eleven Thousand Virgins, O 535
 ,, Ursus and Victor, S. 441
 S. Uvellus, Appdx. 310
 SS VALENTINA, Thea and Paul, Jly. 561
 S Valentine, F. 296, Jan. 90

- SS Valera and Vitalis, Ap 357
 S Valerian, D 197
 ,, Valerius of Trèves, Jan 439
 ,, Valerius (Saragossa), Jan 417
 SS Valerius and Rufinus, Ju. 190
 ,, Varus and others, O 480
 S Vasius, Ap 210
 ,, Vedast, F 179
 ,, Veep, Wymp, or Wennapa, Appdx 246
 ,, Veho, or Vougo, Appdx 234
 ,, Veloc, or Macwoloc, Appdx 176
 ,, Venantius, My 244
 ,, Venantius Fortunatus, D 186
 SS Venerandus and Maximus, My 343
 S Verca and children, Mch 468
 ,, Verdiana, F. 31
 ,, Verena, S 2
 ,, Veronica, F. 73, Jly 287
 ,, Veronica of Milan, Jan 196
 ,, Victor, F. 410
 ,, Victor, Pope, Jly 595
 ,, Victor of Braga, Ap 175
 SS Victor and comp, Jly 498
 ,, Victor and Susanna, F. 246
 ,, Victor and Ursas, S 441
 ,, Victor, Zoticus, and comp, Ap 250
 S Victoria, D. 238
 ,, Victorian, Mch 439
 SS Victoricus, Fuscianus, and Gentianus, D. 136
 S Victorinus, S. 66, N 47
 SS Victorinus and comp, Ap 199
 ,, Victorinus and comp. in Egypt, F. 410
 S Vigilus, Ju 370
 ,, Vigor, N. 25
 ,, Vincent, Jan 331, Mch. 213
 ,, Vincent of Calahorra, Ap. 227
 ,, Vincent of Lerins, My. 337
 ,, Vincent of Paul, Jly 454
 ,, Vincent Ferrier, Ap 87
 ,, Vincent Magdelgar, Jly. 321
 SS Vincent and Lætus, S. 4
 ,, Vincent, Sabina, and Chrysteta, O 649
 S Vindician, Mch 215
 S. Virgilius, Mch 72
 ,, Virgilius, B. of Salzburg, N 570
 SS Virgins in Africa, D 199
 Visitation of the B V Mary, Jly. 32
 S. Vitalian, Jly 404
 ,, Vitalina, F 359
 ,, Vitalis, Jan 156
 SS Vitalis and Agricola, N 107
 ,, Vitalis and Valeria, Ap 357
 ,, Vitus, Modestus, and Crescentia, Ju. 207
 S. Vladimir, Jly 360
 ,, Vougas, Ju. 211
 ,, Vulmar, Jly 489
 S WALABONS, Ju. 72
 ,, Waleric of Leuconay, Ap 3
 ,, Walburga, F 414
 ,, Walfrid, F 309
 ,, Walhere, Ju 318
 ,, Walstan, Appdx 228
 ,, Walter, Ap. 122
 B Walter of Bierbeeke, Jan 341
 S Waltheof, Au 29
 ,, Waltrudis, Ap 131
 ,, Wandregisl, Jly. 515
 ,, Wenceslas, S 421
 ,, Wendelm, G. 561
 ,, Wennapa, Appdx. 246
 ,, Werburga, F 52
 ,, Werenfried, Au. 347
 ,, Werner, Ap. 248
 White Mass, The, Au 261
 S Wilfreda, S. 140
 ,, Wilfrid II, Appdx 217
 ,, Wilfrid, B of York, O 292
 ,, Wilgefortis, Jly 488
 ,, Wilgis, Appdx 177
 ,, Willebold, N. 61
 ,, Willehad, N. 197
 ,, William, Appdx. 224
 ,, William (Bourges), Jan 139
 ,, William, B of Roskilde, S 13
 ,, William of Maleval, F. 253
 ,, William of Monte Virgine, Ju 362
 ,, William of Norwich, Mch 461
 ,, William of Rochester, My 336

- S William of York, Ju 82
 ,, Wilham, Longsword, Duke,
 D 212
 ,, Willibald, Jly 170
 ,, Willibrord, N 170
 ,, Winefred, N 69
 ,, Winnoc, N 164
 ,, Winoc or Guinock, Appdx
 211
 ,, Winwaloe, Appdx 190, 217,
 Mch 49
 ,, Wiro, My 116
 ,, Wistan, Ju 5
 ,, Withburga, Appdx 251, Mch
 309
 ,, Wolfgang, B. of Ratisbon O
 728
 SS. Wulfhad and Rufin, Jly 531
 S Wulfhilda, Appdx 272
 ,, Wulfram, Mch 361
 ,, Wulfric, F. 356
 ,, Wulgan, N 59
 ,, Wulphlag, Ju 71
 ,, Wulsin, Jan 118
 ,, Wulstan, Jan 290
 ,, Wymp, Appdx 246
 S XAVIER, Francis, N 602
 SS Xenophon and Mary, Jan 389
 ,, XXXVIII. Monks in Ionia,
 Jan 175
 S. Xystus (Sixtus), Ap 89
 ,, Xystus, Pope, Mch 489
 S. YARCARD, Au. 262
 ,, Ytha, Appdx 171
 ,, Yvo, My 301, Ju. 132
 ,, Yvo or Ivo, B of Chartres,
 D. 241
 ,, Ywl, O. 135
 S. ZABDAS, F 341
 ,, Zacchæus of Jerusalem, Au
 237
 SS. Zacchæus and Alphæus, N
 378
 S Zacharias, Mch 268
 ,, Zacharias (Jerusalem), F.
 359
 SS. Zacharias and Elizabeth, N
 147
 ,, Zebinas and comp, N. 311
 ,, Zelanus and others, F 376
 S Zenas, S. 397
 SS. Zenas and Philonilla, O
 257
 S. Zeno, F. 249
 ,, Zeno of Verona, Ap 175
 SS Zeno and Zenas, Ju 308
 ,, Zeno and others, D. 224
 ,, Zeno, Eusebius, and comp,
 S. 118
 ,, Zeno, Concordius, and others,
 S 12
 ,, Zeno, Eudoxius, and comp,
 S. 68
 S Zephyrinus, Pope, Au. 311
 ,, Zita, Ap 354
 ,, Zoe, Jly. 127
 SS Zoe and Hesperus, My 28
 ,, Zolus and comp, Ju 387
 S. Zosimus, Pope, D 301
 ,, Zosimus of Syracuse, Mch.
 508
 SS Zosimus and Athanasius, Jan.
 38
 ,, Zosimus and Mary, Ap. 15
 ,, Zosimus and Rufus, D. 219
 S Zoticus, Jly. 501
 SS. Zoticus and comp., Ap
 250

INDEX OF SUBJECTS

[The following contractions are used to indicate the months — *Jan* (January), *F.* (February), *Mch* (March), *Ap* (April), *My* (May), *Ju.* (June), *Jly* (July), *Au* (August), *S* (September), *O.* (October), *N* (November), *D* (December), *Appdx.* (Vol. xv.).]

A

- ABBAT**, cruel, Au. 46 deserts his monastery, Jan 95-6, Ap 123; Ju 238 murdered by monks, Jan 87; O. 432 profligate, D. 200; youthful, My. 279
Abbats, two at once, Jan 12
Abbess, child, Mch 279, 307; S. 270; N. 466 murderess made, Ju. 457
Abbeys given by kings, Ju 134, 457
Abdication of Pope, My. 298, 352
Abelard, story of, Au. 207-11; D 286-7
Abgar, letters of, N. 442; O 679-681
Abingdon, monastery rebuilt, Au. 9-11 - pool at, O 654
"Above," word of comfort, O. 504
Abscesses, saint afflicted with, Ap. 190
Absence of mind, F. 101; Mch. 143, 150, S. 294, N. 165
Absolution sold, Au 293
Abstinence *See* Fasting
Abyssina, Church of, O. 652, 659-668; N. 516-25, 613-15 conversion of, O. 652, 660-1
Acacius, schism of, Jly 100; Au. 87-9, N 487-8; D. 151-5
Accusation against dying saint, F. 426. of theft against saint, Jly 458. of unchastity against Pope, Jly 450-1; D 141 of unchastity against saint, F. 42; My 39, Jly 476, N 313
Acephali, heresy of, Au 190
Achilles Tattius, romances of, S 168, O 621, N 149
Acholyth, saint, Au 143
Acemeti, the Order of, Jan. 232-3; F 92
Acrimony, theological, My. 166, S 459-62
Actor saint, F. 443; Mch 156-8, Ap 189; Au. 267-70
Actress, lessons to be learned from, Jly 6 saint, O 169, 170
Acts of Pilate, Au 329
Acts of saints, fabrication of, Ap 217, 325, 345-9; Ju 78, 295; Jly 277, 285, S 94, O. 10, 13, 62 704, 706 fabulous Jan 70-2, 121-5, 238, 246-7, 276-7, 347-8, F 47, 88-91, 176-7, 190, 231, 248, 330, Mch. 2-8, 45-9, 156-9, 313, 482, 483, 503, 504, 513-15; Ap 1-2, 33, 34-7, 124, 129, 133-4, 177, 180, 199, 223, 227, 250, 301-5, 325-6, 345-9, 352, 358-9, 370-1; My. 54, 59, 64-5, 66, 94-5, 139-40, 141, 158-9, 160, 181, 204, 207-9, 211-13, 237, 244, 262, 306, 307, 333, 342,

- 407, 427, 428-30; Ju. 1, 36-7, 55, 78, 149-50, 154-5, 176-7, 207-8, 219, 221, 239-45, 246-7, 251-2; 270-1, 282, 288, 299-303, 342, 359-60, 366-70, 377, 387, 426-30, 463-84, Jly 3-4, 8-9, 10-11, 23-4, 34-7, 38, 125-6, 127, 131-5, 136, 137-9, 165-6, 167-8, 185-7, 195-7, 203-4, 206, 207-10, 251-2, 257, 277, 283-5, 306-9, 320, 432-3, 485-7, 488-9, 496, 497, 526, 527-30, 553-9, 575-8, 585-6, 593, 613-29, 635, 677, Au. 4, 24, 98, 114, 129, 155, 158, 171-4, 177, 235-6, 256, 315, 384, 401-4; S. 8, 12, 46, 101, 103, 131, 166, 169, 176-7, 180, 184, 246, 257, 259-260, 301, 319, 328, 350, 385, 386, 397, 437-40, 442, O. 1, 16-19, 51, 62, 66-8, 120-5, 132-3, 152-4, 181, 191, 195, 225-7, 258-9, 285-6, 358-9, 454-5, 471-3, 495, 505-6, 620-27, 628-30, 631-4, 649-50, 653-6, 685-6, 697-8, 704, 706, 720-21, 725-7; N. 10-11, 12, 13-17, 65-6, 149-152, 300-4, 502-5, 507-8, 513, 540-2, 562-4, 590-1, 595-7; D. 1, 10, 25-8, 64, 67, 125, 136, 156, 168-70, 228-33, 236, 270, 278-9, 300-1, 405-6, 411 forgeres, Jan. 121, 276; F. 88-91, 190; Mch. 16, 45-9, 267, Ap. 33-4, 177, 223, 301-4, 345-9, 352, My. 139, 158, 161, 164, 188, 237, 262, 407, Ju. 269-70, 295-6, 298, 299, 366-70, 429, 463; Jly. 3, 131-5, 285-7, 304, 320, 485, 594; S. 94, 186, 325, 442; O. 62, 120-2, 124, 152-4, 191, 195, 197, 433, 604, 620, 704; N. 12, 13, 168, 300-4, 565, 590-1: transfer of, F. 276, 444, Mch. 56, 90; Ap. 206, 325, 358-9; My. 244; Ju. 1, 78, 129; Jly. 3, 4, 137, 139, 185, 251-2, 257, 413-19, 432, 485; S. 94; O. 471, 495, 604-5, 619
- Adoption, symbol of, N. 33
- Adna, O. 515
- Adultery, bishops charged with, My. 39. N. 313, 335, D. 242, 249, 251: popes charged with, Jly. 450; D. 141: saint commits, Au. 267
- Advancement, prayer for, O. 482
- Advertisement of self by saint, O. 592
- "Advocate of Christians," title of, Ju. 8
- "Advocate of Poor," title of, S. 406
- Affection between masters and slaves, My. 332, O. 117-18
- lack of natural, N. 351: monastic, Au. 120, 122, 335; N. 392 (see also Monastic friendships): natural, overcome, Jan. 11, 78, 203; Mch. 425; Ju. 235, 487; Jly. 605; Au. 25, 30, 333-4; S. 79-80, 345; O. 531, 557-8, 699; N. 57-8, 257, 446, 489-90; D. 112-13
- Afra (S.), Church of, at Augsburg, Au. 62; O. 326
- Agapæ, Au. 365
- Agaunum, monastery founded, My. 17
- Aghaboe, monastery founded, O. 279
- Agnoetæ, heresy of, S. 190
- Agrestin, schism of, Mch. 499-501; D. 106-7, 113
- Ague, Ap. 168, 191; O. 71, 135, 228-9, 394
- Alaric, K. of Visigoths, Jan. 167; Ju. 372, Jly. 599
- Albert of Austria, murder of, My. 101
- Albigenses, heresy of, Jan. 140-1, 358, 471; Mch. 74-87; Ap. 367, Au. 41, 44-50; D. 271, 289, 292
- Alchemy, Ju. 493
- Alcun, school of, Mch. 473; My. 269
- Aleth, city of, F. 26; N. 338
- Alexandria, catechetical school of, Jly. 167; N. 168, 371, 544, D.

- 24: plague of, F. 449-50; N 374, 376
 Alfred (K), miraculous cure of, Ap. 71
 Algerine pirates, Jly 456
 Algonquin mission, Jly 737, *seq.*
 Alive, burial, Mch. 467; Ap 357; N 237-8
 Alleluja, omitted in Lent, Ap 246 paschal, Ap 73 victory, Jly 684
 Allemanni, incursions of, F 179; Ju 342, Jly. 687, O 6, N. 242-4
 All-fours, saint goes on, F. 256
 All Saints, N 1-10
 All Souls, Jan 27; Ju 241; N 42-7
 Almsgiving, methodical, Jan 348; Jly 460 profuse, Jan 348-9; O 346, 412; D 421
 Alpenstocks, martyrdom by, My 419
 Alphabet inscribed on gurdle, Mch. 257
 Altar, breast used as, Jan 89 brought by doves, Mch. 24 brought from heaven, My 215 deacon's hands used as, Jan 375 linen, consecration of, N 207 linen falls from heaven, Jly 166 linen not to be touched by woman, O. 638: made by S. Bridget, F. 17: of wood, F. 17, S 178: portable, N. 179 saints slain at, Jan 289, 369; My. 112, Jly 273, S 178; D 399 swms, O. 619 vessels sold for the poor, Jan. 23, 407; F 98, Mch 315, 412; Au 15; D. 78
 Altars, numerous, O 160
 Alumbrados, heretics, Jly 720
 Amalarius, story of, My 269
 Amants, les Deux, My. 344
 Amber, superstitious u (of, D 7
 Ambition, monastic, Au. 204, 206-7
 Amen, a ghostly, Ju 317
 America, Irish discovery of, My 219
 Amesbury Abbey founded, Jan. 45
 Amoneburg, monastery founded, Ju 44
 Amphitheatres, Jan 42 attractions of, Au 145-6
 Ampoule, la Sainte, O 7-10
 Amputation of hands, Feb 9
 Anachronisms, Mch. 435, My 94, 139, 158, 159, 343; Ju 155, 299, 300, 366, 463, Jly 107, 150, 211, 284, 578, 593, 620; Au 262; S. 168, 278, O. 16, 19, 53, 153, 226, 471, 621, 634, 652; N 16, 22, 301, 504, 565, 601-2
 Anchor attached to martyr's neck, N 508
 Anchorites, comfortable life of, S 121 distinct from Cenobites, D 56: life of, Jan. 74-7, 95, 151, 215-16, 251-6, 325-6, 374, 433-6, 469; F. 32, 85, 249, 254, 290, 300-2, 356, 369, 427, 445; Mch 97, 274, 275, 278, 389-91, 425-8, 485; Ap 17-24, 79, 115, 166-9, 187, 218, 228, 351; My 48, 125-7, 136-7, 226, 289-90, 323-4, 410, Ju 57, 75, 131, 151-4, 194-5, 235, 236, 238, 248, 254, 290, 337, 339, 362-3, 458-9; Jly 5-8, 14, 38, 154, 351, 358, 404, 447-8; Au 81, 250, 331, S. 3, 9, 55, 120-1, 130-1, 194, 364-72, 382; O. 65, 176-7, 200-3, 207, 422-3, 474, 506-22; N 54-7, 100-1, 110, 219-22, 245, 348, D. 54-5, 143-55, 173 walled up, F. 32; Mch 97, 275, 485; Ap. 79, 218, Ju 458, Jly. 38; Au 28, O. 176-7, 460-2; N 346
 Andenne, monastery founded, D. 207
 Angel acts as guide, Mch. 330, 332; My 54, S. 54-5, 165 apparition of, F 8 attendant, Mch 194, 332; Ap 148, 322, Jly 444; Au 323, N 503 brings a crown of virginity, Jan. 123; My 22; Jly. 203; N. 503 brings a crown to a martyr, Ju 19; N. 229, 564 brings a slate

- from heaven, Au. 182 brings bread from heaven, Jly. 528, N 163. brings chocolate from heaven, Au 323 brings dinner to a saint, O 710 carries a bell, My 144 carries a bishop's staff, N. 75 catches the devil by a snap-collar, N 257 charioteer, Ap 63 communicates a saint, Ju 152 fights in a tournament, Jan. 342 guards a virgin, Jan 120, 147, 319; My 206, N 503 guards sheep, Au 402 indicates site of monastery, Jan 19 makes dress-trimmings, O. 183 ploughs, My 148; S. 181 reaps corn, O. 281 robes a virgin, Jan. 319 rows a boat, O 485 symbol of, Jan 321; Mch 202, Ju 332, Jly 444; Au 157; S. 325 teaches a virgin to read, Ju 197. veils a virgin, Jly 563 visits a saint, My 54, O 559 warns a virgin, O. 707 whips a saint, Ju 252
- Angelic salutation, Jan 144; Mch. 450
- Angelo (S), Castle of, Mch. 230, My 379; Ju 66
- Angels bear the body of a saint, N 542, 594 bear the souls of saints, Jan 56; F 341, Ju 76 comfort martyrs, Jan 5, 333, My 55; Ju. 145, 190; Jly. 528; Au 243 deliver martyrs, Jan 124, 200. doubtful appearances of, My 115, Ju 80 protect a child, Jan 127 same as monks, Ju 99 shelter saints from sun and rain, F 50; Ap 355 sing to a child, F 83, N 315. singing of, heard, Jan 187, 244; F. 51, 83, 382; Mch 30, 58, 468, O. 229
- Angelus, the, Mch. 452; Jly. 343
- Anger, no escape from, Jan 308 to be conquered, Jan. 352; N. 220
- Anglesea, Norse attack on, Ap 213
- Anglican Calendar, errors in, Jan. 99, Ju 294, S 203
- Anglo-Saxon poetry, F 273, My. 348
- Animals, saints and, Jan 31, 33, 282, 287, 288, 384, F. 85, 181; Mch 12, 14, 35, 460; My 15; Ju 125, 337; Jly 22, 262; Au 6, S 9; O 94-6, 211-13, 229, 423; N 68, 491
- Anna-Comnena, historian, Au. 135
- Annunciation, Feast of, Mch. 450-2. Order of, F 111
- Ant-hill, monastery likened to, O 533
- Antichrist, N 251
- Antudoron, N 473
- Antioch, see of, F. 1-3 threatened with chastisement, Jan. 362, 401
- Antiochian schism, F 280, Jly 99-105, D 57
- Antiphonal singing, F. 2; Au. 362; D 89
- Antipodes, N 571-2
- Antipopes, Ap. 88; My 121-2, 352; Ju. 64-7, 382; Jly 375, 632-4, Aug 202; S 354-6, 391-2
- Ants, F 340
- Antwerp Cathedral wrecked, Jly. 214-18. heathenism at, D. 8
- Aphrodite, symbols transferred to saint, Jly. 486
- Apiarius, case of, D. 304-5
- Apocryphal Acts of Priscillianists, Ap. 147: Acts of Martyrs (*see* Acts, fabulous): Books condemned, N. 488 Letters of Constantine, S. 448
- Apollinarian heresy, My. 165, S. 457; O. 613
- Apology of Apollonius, Ap 224; of Justin, Ap 179, of Quadratus, My 383
- Apostasy of bishop, F 6
- Apostles, Church of, at Cologne,

- Mch. 281 : Feasts of, Jan 370, F. 393-5; My. 1-10, 93; Ju 139-43; 419-54; Jly 546-53; Au. 253-60; S 323-5; O 671-8; N. 593-8, D 226-34, 307-10 · separation of, Jly 348
 Apostolic constitutions, N. 507, D 266 title of, S. 24 volume, an, My. 163
 Apparitions, My 115; O. 215, 494, 571-2, 573; N. 18
 Appeals to Rome, O. 306; N 207
 Appetite, ravenous, Jly 11
 Applause in church, My. 133
 Apple from Paradise, F. 177 given to Christ, Ap. 116
 Apples miraculously produced, F. 308
 Aquileja, battle of, Mch. 486; D 101-2
 Arabia, Church in, O. 650-1; N 515-25 · divisions of, N. 514
 Aran, Isle of, Mch. 378; S 133; N 190-2 visit of Bishop of Ardagh to, Mch. 384-7
 Ararat ascended, Jly 356
 "Archangel of Monks," title of, Jan. 24
 Archdeaconery a road to perdition, Feb. 101
 Ardennes, Forest of, S. 39; N. 79
 Ardstraw, monastery founded, Au. 251
 Arenaria, Jan. 285-6
 Arian, explanation of faith refused to, N 291 · heresy, Jan 12, 16, 126, 183-6, 267-8, 334, 400, 404, 423; Feb 93, 278-80, 433-4, 446-7; Mch. 174, 213, 314-19, 371, 407-8, 412-13, 492-5; Ap. 64, 73, 113, 183-4; My 30-53, 74, 129, 132-8, 183, 317, 319-20, Ju. 41, 69-70, 164, 165, 285-7; Jly. 310-16, 354-6, 399-402, 632; Au. 26, 387-9; S. 248-9, 292, 351-7, O. 119, 287-90, 496-8, 721; N. 48-53, 58, 164, 245, 498, 510, 547; D. 63, 66-7, 69, 74, 78, 81, 85-91, 93, 149, 191-7, 225, 299: saint, S. 248-9, O 496-8; N. 48-54
 Arians, persecution by, Jan. 12-18, 90, 223, 404, F 281, 466-7; Mch 174, 213, 371, 407-8; Ap 64, 73, 184, My 319-20, Ju 69-70, 286-7, Jly 310-16, 400-3, 632; Au 389, S 352-6, O 287-90, 496, 721; N 51-3, 164, 245; D 69-70, 194-5, persecution of, Au 26; O 606, S 248-9; N 510
 Arians, Semi-, Feb 280, Mch 314-18, 492-3; My 127; Ju 69-70
 Ark of Noah discovered, Jly. 357
 Arm of executioner becomes rigid, S 37, 44 · of saint broken, Ju 247; Jly. 262 of saint pulled off, S 141
 Armagh founded, Mch 301 lay usurpation of, Ap 106, N 87, 91-2
 Armenia, conversion of, S 442
 Armorica, ancient extent of, Mch. 288
 Arrow pierces S. Theresa's bowels, O 371
 Arrows, martyrdom by, Jan 285, 304, Ap. 37, 73; Ju. 361, Jly 530, O. 556; N. 38-9, 465 marvellous, My. 115 · symbol of, Jan. 305, Jly. 531, S. 10; O. 414, 556
 Artifices in war, Ju 405
 Artistic bishop, N 469
 Asceticism and sensuality, Aug 320, 352: extraordinary (*see* Austerities): moderation in, Jan 69 · obedience better than, Jan 69 should be secret, Jan. 374
 Ash-tree of S. Kenelm, Jly. 427
 Ass bites a lawyer, S. 128 · determines boundaries, N. 160 discovers a spring, D. 54 kills a wolf, D 21-2 restored to life, Jly. 690 · restores its shoes, Ap. 32: saint rides, O 583 · symbol

- of, Ap 32; My. 261; Jly 690
the body regarded as, O 508
Asses obey a saint, O 513
Assistant saints *in extremis*, D 28
Assumption of B Virgin, Au. 141-3
Athanasian Creed, My. 340
Attic honey, D. 28
Attila, invasion of, Jan 48, 101;
Ap 158-9, Ju. 23; Jly. 635;
S 103, 153
Augustinian Canons, F 105
Austinites, extraordinary, Jan. 12,
30-1, 72-80, 222, 253, F 32-3,
225-6, 256, 298, 369, 427, 445,
453, Mch 275, 373, 426-7, Ap
17-24, 25, My. 323, 392, Ju.
320-1, Au. 318, 320, 327; S
161, 174, 254, O 188, 206-8,
474, 488; N. 351, 527, 534,
538, 560, 587, 604, 606, Appdx
66
Austrasia, king^dom of, F 25
Avalon, Isle of, Jan 5
Axe, emblem of, F 343, Ap 368:
martyrdom by, F 367; Ap
367, 371; My 419, Ju. 172,
376
- B
- BABE boiled in caldron, O. 634
found in eagle's nest, S. 140.
required to announce its parent-
age, N 313
Babelmandeb, Straits of, forced,
N 523-4
Babies, miraculous production of,
N 601-2
Bacchantes beat saint to death, Ju.
257
Bacchus, hymn to, N. 53
Badon, Mount, battle of, Jan 441
Bagaudæ, insurgent, S. 330-1; N.
629
Baker saint, My. 336
Balla, monastery founded, Jan. 20
Ballads incorporated in lives of
saints, O 421: used as texts,
My. 349
VOL. XVII
- Bamberg, see founded, Mch. 53,
Jly 377-8; S 29
Bamborough, siege of, Au. 398
Bandage falls from heaven, Jly 36
Bangor (Irish) founded, My 142-3:
restored, N. 87, 89
Bangor (Welsh) founded, My 142.
destroyed, N. 196 massacre at,
My. 390
Banker saint, O. 348
Banner of S Wilfred, O 315:
symbol of, Ju 406
Baptism administered by Christ,
Jly 529. by father, My. 125.
by immersion, Jly 63 death
after, S 48. doubtful, N 599:
enforced, D. 60. erroneous
form of, N. 570-1: in a cloud,
Mch 158: in blood, Ap 175;
Au 270; O. 118, D 100.
its nature, Jan. 2: miraculous
light at, F 443; Au 269, 279;
S 270 of heretics, Au 16, 75;
S 220-2; O 688-92, N. 378,
370
Baptismal Creed, My. 140. cus-
toms, Au 361
"Bara," title of, D. 105
Barathnun, imprisonment in, Jan.
124; S. 289-91, 445; O. 626;
N 15, 335
Bards, Ju. 114, 239, O 291;
Appdx. 167
Bark, books made of, Mch 471
Barking, monastery founded, Mch.
446; O 281-2
Baronius, errors of, Ju 1; Jly.
135, 137, 205-6, 321, 356; Au.
78, 108, 223, S. 100, 385; O
50, N. 224, 563
Barrel, saint born in, D. 120:
saint lives in, F. 445
Barrenness cured by abbot, N.
203
Basulisk, Ju. 430
Basin, symbol of, Jly. 497
Batavia ceases to be an island, O.
538
Bath, a cold, My. 323; Ju 35:
hot springs at, My. 285:
2 A

- marvellous effects of, Jly. 11 .
miraculous, D. 26 . rarely used,
O 445
- Baths, martyr condemned to, N.
504
- Bayac, monastery founded, Jan
96
- Beam, martyr crushed under, Jan.
339 miraculously lengthened,
223; O. 282
- Beal, Jan 243, 376; F 85, 181,
Mch. 459; Ju 75, 362; Jly
679 and saint, Jan. 243; F 85,
181, Mch 459; Ju 75; Jly
262, S 47, 122; O 211-13,
229, 423; N 491; D 412 .
carnes loads, Mch 459, S 47,
122-3: defends virgin, D. 412
discovers a mine, S 95 martyr
exposed to, Au. 330; S 258;
O 229; N. 459 . splinter
plucked from foot of, F. 85, Ju.
75
- Bear-baiting forbidden to monks,
My 271
- Bearded virgin saint, F. 348; Jly.
488
- Beards forbidden, N 584
- Beasts, exposure to, Jan 120, 277,
278, 284; F 4-5, 346-8, Mch.
111-13, 114, My 237, 244; Ju.
14, 17, 336; Jly 679, Au 115,
162, 179, 330, S. 302; O. 276-7;
N. 459; D. 300
- Beatific vision, Mch. 151
- Beating into virtue, N 490
- Bedcover of fur, O 36; of mouse-
skin, Jly. 83
- Bed-curtain given as clothing, O
729
- Bed not slept in, O. 214, N 550:
of iron, martyrdom on, Jan
440, F. 176; My. 418; Jly
678; Au. 110; S 179; O 133
- Beefsteaks, why underdone, O 711
- Beer dedicated to Woden, O 420;
N 497 . foams miraculously, O.
431-2: miraculously increased,
O 580
- Bees brought to Ireland, F 291, Mch 14, 224 keeping of, in
Brittany, Mch 225 sign of
election, My 79 swarm on
saint's mouth, Ap. 65, Au 42;
D. 76
- Beggar saint, Jan. 233, F 220-4
- Begging forbidden, Jly. 462
- Beghards, the, Jly. 339, Au 41
- Begunes, Order of, D 207
- Belgrade, relief of, O 599
- Bell, Jan 19, 366, 468; Mch. 223,
225, 226, 248, My. 144; Ju 92,
112; Jly 40; Au 6, 9, 13; S
6; N 154 arrests a massacre,
S 6 . indicates site of monas-
tery, Jan 19; N. 154 made
by a saint, Au 9, 13 made of
butter, Jly. 40 multplies itself,
N 154 serves as a baby's bottle,
Au 6
- Bells ring miraculously, Mch. 211;
My 149; S 52, O. 67, 576;
N. 62, 68, 154
- Benedictine Order, attempt to
suppress, My. 296
- Benefices given to bastards, D.
162 given to children, Ju 173;
Jly. 86-7; S 161, N 113, 116-
17; D. 71 . given to laymen,
N 398; D. 162
- Bereavement, comfort in, O. 483
- Beresynth, an idol, Ju. 337; Au
230
- Bergamo, churches built at, S 49
- Bernicia, kingdom of, O 230,
234
- Berytus, legal school at, Jan. 389,
Ap 12
- Beverley Abbey founded, My 110
- Beziers, siege of, Au. 46
- Bible, use made of, Jan 88,
95, My. 304: written by Alcuin,
My 276. *See also* Holy Scrip-
tures
- Bier miraculously shortened, N
237
- Bigamy allowed by Luther, D.
202
- Binding books, My 268
- Bird, example from, F. 243 . re-

- stored to life, O 16 sings to a dying saint, N 456
- Birds and saints, F 85, 385, 448, Mch 345, 502, Ap 56, 132, 171; My. 145, 148, Ju 29, 238, 372; Jly. 15, 22; Au 6, 321; O 6, N. 456
- "Bishop of Bishops," title of, Au. 17
- Bishoprics given by kings, Ju. 49, 134, 163; Jly 19, 20, 117, 372: hereditary claims to, F. 322; Ap 106; N 87, 91-2
- Bishops, adulterous, Jly. 156, 401, 402, O. 159; N 313, 385, D. 30, 242, 249, 251: and women to be avoided, Jly. 523 apostate, F. 6, N 48 avaricious, N 291 beat emperors, D 30. beat their clergy, O 160, D. 34, Celtic, Appdx 30-1: coadjutor, first instance of, Jly 94 connive at murder, N. 184 consecrated by Christ, S 378. criminal, Mch 20; My. 266; S 5, 41; N. 52, 313; D 249. cruel, Au. 47; D 45, 292. deceitful, N. 543 desert their sees, F. 40, My. 118, 185; Ju. 57, 259; Jly 279; S 126, 243; O. 434, 573, 709, N 232, 313, 338. displaced by kings, Mch. 20 dress as laymen, N. 141. drunkards, S 284 elected by parliament, D. 264: envious, F. 64; German, character of, Mch 180-1, My. 266-7; Ju 49, 63; S. 30, 282-6; N 184, 211: guilty of murder, Ju 49: incite to murder, D. 110 insolence of, Jly. 377; S. 283; D. 30, 40, 42-3, 110: jealous of their rights, Mch. 180, N 207 kick nobles, D. 110: laymen elected, F. 13; My. 299; Ju. 283, 336; Jly 682; D 75 luxurious, S. 30, 126, 282-4, N. 141; D 32, 35: married, Jan. 44, 58, 182, F. 13, 81; Mch 173, 457; Ap. 8, 38, 41, 140, 141, 318, 363; My. 125, 414, 416, 223, 271, 281, 355, 359-66; Ju 337, 401, 420; Au. 11, 12, 103-4, 139, 248, S. 70, 376, O. 10, 290, 645, 699, N. 206, 346, 414, D 304. nepotism of, Ju. 6; D. 36-7. ordained by force, Jan 14, N 245 perjured, D. 393-4. pomp of, S 30, 282-6 popular election of, F. 13, 86; My. 14; N 246; D. 74. pride of, D. 391. rapacious, Mch. 180-1; Ju 6; Jly 372, 373, 374; S. 126, 243; O. 142, 145, 449, N. 116; D 31-5, 38-41 rebuke kings, My. 335, 413 regionary, F. 183; Mch. 208, Ap 342; S 122; N. 59, 84; D. 274 resign their sees, F. 24, 49, 186; My 135; Ju. 56; S 39; O. 617. sell benefices, D. 35-6: shameful tricks played on, Jly. 405. treacherous, N. 542-3. turbulent, Mch 20; Ju. 47, 360, Jly. 42, S 126, 312-314, O 159-60, N 231, 250; D. 30, 40, 94, 391: under canonical age, Jly. 24, 87, 377; Au. 189, 191; O. 2, 3, N. 114, 116-17, D. 71, 246 warlike, Ju 49, 360; Jly. 42-3. whip old women, S 126
- Black Forest, Ap. 351
- "Black Joan," D 76
- Blackberrines, Mch. 70
- Blacksmith saint, F 447
- Blasphemy, temptation to, Ap 8
- Bleeding, N. 410. relics, S 164-5; O. 63, 68, 116; N 12
- Blessed, the Isles of the, D. 123
- Blessed Sacrament, delight in receiving, S. 403: devotion to, Jan. 142; F. 175, 193, Mch 154; Ap. 79, 119-20; My. 68, 105; Ju. 174, 216, 225. mule adores, Ju. 188; recourse had to, Mch. 142; My. 103. visions concerning, Jan. 197; Mch.

- 238, Ap. 78, 80, Au 30; O 570, N 400
- Blind saint, F. 244, 258; Mch 489, Ju. 241; Au. 140, S 136
- Blindness conducive to meditation, F 20. miraculously healed, Mch 14, 332; N 455 inflicted, O 485
- Blood, Council of, Jly 221
- Blood, drinking, Jly 267 earth turned to, S. 52: effervesces, O 116: exudes on approach of a murderer, Mch. 449. fossil, N 148-9; liquefies, Jly 587 trickles from feet of saint, N 136
- Bluebottle, the pet of a saint, O. 709
- Blue-devils, O. 213
- Blue veils, Jly. 109
- Boar indicates site of monastery, Jan. 282; Mch. 248. king transformed into, S. 440. saint protects, Jan. 282: turned to stone, N 315
- Boar-hunt, Jly. 502
- Boasting, saintly, O 595
- Boat breasts stream, Jan 86; O. 323; N 258 follows the ship, Ju 245. manned by angels, Ju. 150. saints exposed in, My. 239; O. 721 symbol of, My 238; S 74
- Bobbio founded, N. 500
- Bodkins thrust through ears, Ju. 177. *See* Skewers
- Body floats against stream, O. 56. multiplies itself, Jan 96; Mch 95, Jly. 426; O 656: regarded as an ass, O 508
- Boedecken founded, O. 128-9
- Boiling of body to obtain the bones, N. 184, 443 water, martyrdom in, F. 174-5
- Boldness before kings, D. 62, 82, 97
- Bolivia, missions to, O. 218-20
- Bollandists, S 265, 377
- Bonæ Memoriae, on tombs, O. 705
- Bonds, the Cross the strongest of, F. 112
- Bonhomme de Fatonville, O 708
- Bonus, heresy of, D. 408-9
- Book floats, N 337 miraculously kept dry, Jan 24, 467, O. 655, Appdx 178. of Life, Jan 125 tied to a stake, F. 65
- Books borrowed and returned, F 250: brought to England, Jan 168, 170 importance of, N 552
- "Boots and Belly," F. 370
- Boots, torture of the, O. 155
- Borromeo family, N 113-15
- Bosham founded, O 307
- Boswell, an ecclesiastical, My. 325
- Bough, saint floats on a, Au. 182
- Bow and quiver, symbol of, Mch 208
- Bowels unwound, Ju. 20
- Bowl, saint sails in a silver, Ju. 35, Jly. 625
- Boy confessors, F. 83; Ju 139, 291-3; Jly. 323; N. 322-5 girl changed into, O. 655 given a benefice, S 161 (*see* Bishops under age) killed by Jews, Mch 447-9; 461-6; Ap 221-2, 248-249, 250, 381-2, Jly. 592; Au 279, O 597; N. 21; Appdx. 202 martyrs, Jan. 124-5, 246-247, 370-1, F. 147-8, 150, 156-7, 164-7, 171-4, 262, 358, Mch 447-9, 461-6; Ap 221-2, 248-249, 373, 381-2; My 160-1, 188-191, 244, 428-30; Ju 5, 17, 207, 220, 377; Jly 592; Au. 143, 158, 162, 223-4; S. 98-100, 103, 229, 326; O 226-7, 471-3, 597; N. 21; D 69; Appdx 202: pope, My 351. restored to life, S 261; D. 66-7
- Bracelet given by an angel, S 94
- Bramble conceals tomb, F 38
- Brazen bull, martyrdom in, S. 319
- Bread changed into chips, S 241; N 347, 426. changed into pearls, N. 409: changed into

- roses, Mch. 121; Ju 217; Jly. 87; S. 164, 241; N 425-6. changed into stones, Jan 61; S 139; O. 249 chokes Earl Godwin, O 340: cures the sick, S. 163. from heaven, Ap. 115; N. 16. unleavened, Ap 246
- Breakwater, miraculous, Ju 57
- Breasts cut off, Jan 85; F. 137, Ap 208; My. 95; Ju 77, 146, 349; S. 321; O. 698; D. 27 emit light, O. 178. three breasts, Appdx. 193
- Breath, intoxicating, Au. 40. vari-coloured, Ap. 63
- Biemen, diocese united to Hamburg, F 68, 98
- Brentford, battle of, O 328
- Brethren of Our Lord, O. 125-8
- Bretwalda, title of, F 406, Au. 68; O. 232, 244
- Breviary, errors in, Ju. 306 Franciscan, Jly. 32
- Brian, title of, D. 221
- Brians, saint rolls in, Mch. 390
- Bribery at Rome, O 334, N 207-8, 353, 361, 367; D 248, 251, 255, 256
- Bridge-building, Jan. 145. miraculous, My 205
- British refugees, Ap 169; Appdx 24-27, 88-110: saints, Jan 5-7, 28, 44, 57, F. 140, 190, 238-41; Mch 51, 69, 214-15, 274, 437-9; Ap 71, 185-6, 200-2, 260, 364; My 16-20, 137, 215-16, 239-42, 417; Ju 35-7, 57, 155, 190, 203-4, 294-9; Jly. 1-2, 39-40, 140, 146-9, 697-8; Au. 6-8, 82-6, 181, 345-6; O. 176-7, 476, 616, 620, 640-7; N. 186-197, 318, 599-600; D 13-16, 128, 160, 180; Appdx. 1-119, 159-326.
- Brittany, Celtic Church in, Appdx. 51: migration into, Appdx 24-6, 87-119, 159-326
- Broken heart, death from, Ap. 112; D 171
- Brothel, virgin consigned to, Jan. 319; Ap 360; O. 626; D. 11
- Brucheton, O 514
- Brunanbough, battle of, Jly. 112
- Brunswick, conversion of Duke of, S 298
- Brychan, family of, Ju. 36; Jly. 146-8; Au 6-7, 181; O 178
- Buddha as a Christian saint, N. 562
- Buffalo, Jly. 15
- Bull, brazen, martyrdom in, Ap 136; My. 66; S 319. bating forbidden, N. 127: emblem of, N 591. fight, excitement of, Au 146. saint gored by, Jan. 120; Ju 17: saint tied to, N. 590-1
- Burial alive, martyrdom by, Ap 357; N. 237-8. rites, Au 363. to the waist, S. 46
- Burning of heretics, N. 236
- Butler, Alban, distorts facts, O. 489

C

- CÆSARIAN process, Ap. 217; Au. 401
- Calatrava, Order of, F. 30
- Caldron, martyr immersed in, F. 174, 317; Jly. 20; O. 265. See also Oil and Pitch
- Caledonia, extent of, Ju 108
- Calextin schism, O. 594
- Calf restored to life, O. 653
- Call to preach, My. 157
- Caltraeth, battle of, O. 647
- Calumnies against bishops, N 52
- Calvinists, conversion of, Jan. 446-57; Ju. 227, 484. doctrine of grace, My 338. violence of, Jan 142; My 243, 312; Jly. 212-50, 385-98
- Calw, family of, N. 62
- Cambrai, see founded, O. 10
- Camel weeping, S. 400
- Campine, conversion of, S. 276; N 79

- Canada, missions in, Jly. 733-88
 Cancer, saint suffers from, Jan 69, 461; F 112, Ap. 193, Ju 148; O 126, Appdx 172.
 Candle brought from heaven, O 655: held by dying, Mch 184 light, reading by, Au 14: lights miraculously, Jan. 51, 109, 288, 461; Ap 355; Jly 168, S 162, O 209, 434, 576, 654: not extinguished by wind, Jan. 461; F. 361; Ap 355: sets fire to a pillar, Jly 125-6 symbol of, Jan. 163, F. 49, 214
 Candlemas, F 35-6
 Candles as symbols of joy, Jan. 17: borne in procession, Jan 17, 159; O. 177: on festivals, Jan. 97: on altars, Mch 242, Jly 166: used as tokens of faith, O. 289
 Cane, letter concealed in, Jan. 429
 Cannibals, mission to, N 595
 Canon of Scripture, S. 411
 Canonisation by imperial orders, Mch. 284 popular, N 248, 414; D. 269
 Canonry given to a child, Jly. 341; S. 161
 Canons excommunicate their bishop, N. 124-5: unruly, My. 223, 281; Au 11; N. 124
 Canossa, Henry IV. at, My. 374
 Canterbury taken by Northmen, Jly. 643
 Cap and bells, symbol of, Au 270
 Capitulary of S Aldric, Jan. 97
 Captives, Christian, My 97: liberated, Jan. 50, 414, 471, O 429; N. 254: ransomed, Jan 470-1; F. 85, 98, 227; O 432
 Capuchins, devotion of, N. 135
 Caravans plundered, N 516
 Cardinal, child made, My. 82
 Cardinal's hat, Jly. 344
 Cards blessed, N. 628. burned, O. 591
 Carinthia attacked by Huns, N. 572. conversion of, N 572-3
 Carmelite Order founded, N 527 in England, My 226
 Carnival forbidden, N. 140
 Carols, O. 108; D 7
 Carpenter saint, Mch 484, D. 228, 231
 Carpenter's son saint, S. 132, 134, 292
 Carthusian Order founded, O. 142-9: houses in England, N 397
 Cashel, archdiocese, Ap 107
 Caste, F. 115, 118
 Casturs, sack of, Jan 101
 Catacombs, Jan 285-6, Feb. 249; Au 35, 111; S. 451
 Catalepsy, Jly 534-41; S 158-9
 Catasta, F. 176
 Catechetical School, Alexandria, Jly 167, N. 168, 371, 544; D. 24
 Caterpillars, D. 317
 Cathari, heretics, Mch. 75; N. 431
 Catholic, title of, D. 93
 Cats, Ju. 249: symbol of, My 305
 Catskin, myth of, Jan 292; My 207, 211
 Cattle passed through split trees, D. 7
 Cave, exploration of, Au 217: mysterious maid in, My. 211: temple, D 54
 Celestine Order founded, My. 296
 Celibacy, clerical, F. 344, 427, 455, Ap 123, 237, 312; My. 281, 286; Ju 62, 389-99, Au 11, 103-4, S. 137-8, 170-1, O. 351, N 206, 214, 360; D. 263, 265
 Celle, La, founded, Jan 114
 Cells, desert of, Jan. 29
 Celtic Church, peculiarities of, Appdx. 40-43, 43-6. reduced to Roman obedience, Jan. 94; F. 217; Mch. 342; Appdx 50, 54
 Celtic usages, Jan 93-4; My 349; N. 493-4; Appdx. 31-41, 43-47, 54
 Cenobites and Anchorites, D 56

- Censer, F. 196 not to be touched by a woman, O. 638; self-kindled, Jan. 152
- Census, disturbances caused by, My. 366, N. 475, 479
- Centule founded, Ap 352
- Centurion flies persecution, Jan 42 martyrs, Jan 42; O 719 saint, F. 38
- Cerfroid, monastery founded, N. 485
- Cerinthus, heresy of, D 310
- Chablais, conversion of, Jan 446-457
- Chan-mail, F. 356
- Chams fall off, Jan. 59. of S Lawrence, N 166. of S Peter, Mch 514; Ap. 2; Ju 431, S 153
- Chair kissed, O 459 of Bede, My 409 of Camech, O. 279. of S Peter, Jan 275; Ju. 431: torture of red-hot, Jan. 440; Ju 13, 17
- Chalcaion, image of Christ in, F. 95; Ap. 43-4, My. 177-8, 420, Au 107
- Chalice and Host, symbol of, D. 28
- Châlons, battle of, N 380. sacked, Jly 440
- Chancel not for laymen, D 94
- Chariot-races, Jan 42, Au 144-6
- Charity above fasting, N. 57 disgusting, O. 484. dishonest, F 32; Ap. 354; S 163, 240; N 347: examples of, Jan. 29, 135-6, 349-56, F. 24, 243, 281; My. 117, 202, 203, 411-412; Jly. 5-7, 15, 43, 288, 335, 336; S. 84, 130, 346-7, 425; O 73, 88, 198, 730, N 132-4, 242, 405, 425-7, 450-2, 490, D. 65, 153, 181, 281. heals, 1, 376: lack of, F. 233-6: Order of, Mch. 167. profuse, Jan. 23; F. 16; S. 412; N. 292, 329, 333 the supreme rule, D 285 to the dead, Jan 23
- Charlemagne claims ecclesiastical supremacy, My 270-1, Ju 163: coronation of, Ju 160 extends the Creed, Ju 165-9 reforms the Church, My. 266-72 wives of, Ap 275-6, Jly. 262-3
- Chartreuse, La Grande, Ju. 378 founded, Ap 9, O. 146-9, N 396-7
- Chasuble sent from heaven, D 116
- Cheerfulness, Jan 374
- Cheese fancied by monk, My. 155 turned to stone, O. 640
- Chertsey, monastery founded, Mch 446, O 281
- Chess-boards burnt, O. 591
- Chest, oak, My 104
- Chester - le - Street (Concester), bishop's see at, S. 51
- Chicken not meat, N 409
- Chilblains, Jan. 451 saint suffers from, Ju 458; O 461
- Child Jesus crowns a saint, S 55. held by saint, Mch 183; Ju 188; S. 360; N, 323, 325, 349-350
- Child, dedication of, Jan. 46-8, 126, 248, 306, Mch. 243, 508; My. 263; Jly. 606, 703, N 342, D. 105, 172, 281, 283, 420. eaten by mother, Jan. 210 given benefices, Ju 173; Jly 86; S. 161; N. 113, 116-17, D 71. kiss of, cures blindness, Jan 112 lesson of, Ju. 243 proclaims a bishop, D. 75. set in the midst by Christ, Ju. 465
- Child saints, F. 147, 150, 156, 164-7, 171-4; Ap 24, Jly 359, Au. 221-3; S 12, 35, 70 *See also* Boy saints
- Childbirth, angel assists at, D. 120 assistance in, Jly. 123. saints assists at, O 220-1
- Children, loss of, O 198: love of, Jan 456 voices of, Au 333
- China, missions to, N. 674
- Chocolate brought from heaven, Au 323
- Chonster whipped, N 24

- Christ baptizes, N 66 · in person ministered to, O 589 letters of, O 679 portraits of, O 681-4 · present with sufferer, Ju 147 relatives of, O 562-4, 674-6 · serves at mass, D 72
- Chronicle of Radbod, N 592
- Chrysostom, persecution of adherents of, Jan 164
- Church, acclamations in, Jan 431, F 279 monolithic, N 348 of stone, Jan 169 of wood, F 326 · represented as a wife, F 436-7; Ap. 109, S. 91 · supported by SS. Francis and Dominic, O 79
- Churches destroyed by edict of Diocletian, O 566, 601
- Churching of women, F. 36
- Ciborium, Jan 26, N. 400
- Cicero, study of, S 453-4
- Cinderella myth, My. 10
- Circumcelliones, Au. 370
- Circumcision and baptism, Jan 1-2
- Circumstantial evidence, Ju. 254
- Citations before God's throne, Mch 501
- Cities submerged, O. 618
- Clairvaux founded, Au. 198-9
- Clares, Poor, Mch 182, 184; Au. 123
- Classic studies, evil of, S 453, N. 404
- Claves Confessionis S. Petri, My 184-5; N 75, 581
- Clean saint, S 255
- Cleanliness, revelations concerning, O. 185
- Clementine Recognitions, O. 154; N. 507
- Clergy, disorderly, N. 121 · foppish, S. 457; D 141 immoral, N. 333, D. 267 · luxurious, N. 257
- Clerical celibacy, F. 344, 427, 455; Ap. 123, 237, 312; My. 281, 286, 355, 359-66; Ju 62, 389, 399; Au 11, 103-4; S 137-8, 170-1; O. 351; N. 206, 214, 360; D 263, 265 · coxcomb described, D 141 immunities, D 349-55, 385 · insolence, Au 104 pride, N 435
- Cloak used as boat, Jan 358; Ap 32: divided with a beggar, N 242, 261 given to a beggar, N 423; D 337: miraculously sent, N 71
- Clockmaker saint, Ap 120
- Clonfert founded, Mch. 333; My 222; Au 38
- Clonmacnois founded, S 134
- Clothair, descendants of, N 72 · marriages of, Au. 131-2 · murders his nephews, S 106
- Cloud miraculously dispersed, O 730-1
- Clovis, conversion of, F 179-81: descendants of, O 157
- Clown, charity of a, My 410
- Clown's cap and bells, Au 270
- Club, brains dashed out with, Jan 305; My 9; Au. 160, 175; S 247; N 586 · of Hercules, D. 8 of the Devil, N 163
- Coachman saint, F 18
- Coals carried, Appdx 175 · miraculously kindled, N 337 · saint laid on red-hot, Ju 146
- Coat, an old, Ap. 113: of aims, Jly 272; Au. 326 · of mail worn by saint, F 356-7; Ju 362; N 349, 587 one between several scholars, Ap 50
- Cock and hens, Jan 248
- Cock and mouse wake a saint, O 709
- Code of K. Ina, F. 186; Jly 169
- Coffin filled with food, S 50 · used as a bed, N. 527
- Comage, new, in England, F. 356
- Coincidences, Ap 71
- Coins, hung round neck, Jan 47: of S. Eligius, D. 4 Roman silver, Jly. 17
- Cold endured, O 493 · steel, effect of, Au. 163; S. 400
- Coldingham, monastery founded, Au. 280-1

- Collar of S Alexander, Mch 513, 515
 Collect, F 260
 Colobium, a linen tunic, Jan. 340
 Cologne, crucifix at, S. 52-3 · notes at, D. 43-5: school at, Mch 127, 130: tomb of Albertus Magnus at, Mch. 127, 130
 Colonna family, My. 291
 Comb of S. Majolus, My 156: symbol of, S. 3, 4
 Combe, a valley, N 348
 Communion by angels. *See* Angels
 Communion, delight in, S 403. frequent, Jan 374; F 435, Ju. 216; Jly 346; Au 87 given by Christ, Jan 197, Au 403 miraculous, Jan. 197, 348, Ju. 152, 268; Au 403; N. 323 in both kinds, Ju 147 of children, Au. 279: of saints, doctrine of, N. 2-8. under one kind, O. 593
 Como, filling up of Lake, O. 697
 Compasses, Jan. 113
 Conception of B V. M., Jly 340
 Conclaves, law of, My. 295
 Concord between abbots, Jan 12
 Concubinage at Goa, N. 615
 Condate founded, F. 452, Mch 372
 Conferences, religious, My 391
 Confession, frequent, O 218. general, Jly. 459. in Celtic Church, Appdx. 76. of women not to be heard in a room, Ap. 10. seal of, My. 229, 234-5: thrice a day, D. 107: to a layman, Jan. 343
 "Confession," a church, My. 246
 Confessions of S. Augustine, O. 369
 Confessors, easy-going, Au 22 indiscreet love of, O. 364-5, 368. sensible, Au. 322
 Confirmation administered on the road, O. 40: by priests, N 617 neglected, S 188; proper age for, N. 79
 Conflagration miraculously extinguished, N. 153
 Congé d'élire, N 397-8; D 344
 Consanguinity, bar of, Mch 16. in Ireland, N 90
 Consecration by a single bishop, Jan 189. of bishop in dream, Jly. 607: violent scenes at, Jan 414
 Consistory, papal, bribery in, N. 207
 Constantinople, pope sent to, My. 396-7; Ju 273; Au 271 see of, claims equality with Rome, Ap 156; Jly. 96
 Constitutions of Clarendon, D 354
 Constraint, injudicious, Ap 266: to Christ's service, F 409
 Consubstantial, Mch. 314, 316, 492
 Consumption, saint dies of, Jan. 69, 173; Feb 380
 Contemplation, long, impossible, Jan 30
 Contest for bishopric, O 21
 Contunence, example of, Mch. 124-5: of married bishops, Jan. 182
 Conventuals and observants, O. 589
 Conversion, gradual, Au 349: sudden, Jan 55, 81; F 106, 195, 371; Mch. 377, My 381; Ju 58, 262, 489, 490, Jly. 291, 701; Au. 21, 252, 355-9, S. 139; O. 74, 252
 Convicts, work among, Jly. 460
 Cook becomes a bishop, Au. 10: honour paid to a, S 244: roasted, My. 230 saint, Ap. 59; Au 10: S. 240-5: tidiness in, Au. 10
 Cookery, good, Au 342
 "Copronymus," nickname, O. 451
 Coracle, My. 219, 222; Jly. 28, 434; Au. 6, N. 162, 192
 Corbie, new, founded, Jan. 35; F. 60: old, Jan 34, 397
 Cords shaken off, O 624

- Corea, missions to, N. 675
 Cork, see founded, S. 377
 Cornish bishopric, Appdx. 49.
 saints, Jan. 44-6, 57; F. 273,
 448; Mch. 69, 214-15, 274,
 437-9; Ap 71, 364; My. 239-
 42, 417; Ju. 35-7, 57; Jly
 146-9, 697-8; O. 639, 657-9,
 717, N. 186-95, 314, D. 273,
 Appdx 149-322.
 Corn-mill, king grinds a, Mch
 214
 Coronation at Aix, Ju. 163; Jly
 371. at Rome, Ju. 66, 160;
 Jly. 375
 Coronet laid before crucifix, N.
 418
 Coroticus, letter to, Mch. 285, 301,
 437
 Corporal, miraculous recovery of,
 D. 17
 Corpse, carried by saint, Jly 54-5;
 O 598 designates murderer,
 Jan 417
 Corpus Christi, festival instituted,
 Mch 145; Ap. 78-87
 Council of Agde (506), D 113
 Aix (782), Jan. 436: (799), Ju
 159 (860), D. 201
 Albi (1176), Mch 74
 Alexandria (231), O 687. (320),
 F 433; My 30-3 (362), F
 280, My 49
 Altino (802), Jan. 436
 Antioch (252), N 372 (264),
 Jly. 93; O 694; N. 377
 (269), O. 695-6; D 300
 (270), N. 377 (331), Jly
 401-2: (341), My. 41; Jly.
 354-5: (361), F 279; Ju
 285. (379), F 282; Mch 321
 Aquileja (381), Jan. 273; D 80
 Arminum (359), Jan. 184;
 Mch. 317-18; Ap 48, 183;
 My 48, 359; S. 356
 Arles (314), S. 232; D. 192:
 (451), O. 646; (454), O 646;
 N 570. (475), Au. 387; S
 415-16
 Autun (1077), O 143
 Council of Basle (1441), Jly 32,
 O 594
 Bayonne (1300), D. 108
 Beaugency (1104), D 254
 Berne (577-81), N 385
 Bourges (1113), N 213
 Bourgos (1089), My. 365
 Caerleon (529), Mch 12.
 Capua (391), D. 408-9
 Carthage (222), O. 686-7 (251),
 S 220: (254), S. 221 (255),
 Au. 17; O 689-90 (256),
 Au. 17; S 221, 223, O
 690-91 (404), Au 370
 (410-11), Ap 89, 90, 138,
 Au. 372. (416), Ap 139
 (417), D. 302. (418), Ap
 140, D 303
 Chalcedon (451), F 300-2, 337,
 368; Mch. 232; Ap 102-5,
 152-8; Jly 96, 99, 102-5; S
 156, 258, O 614; D. 57-8
 Curia (412), F 259
 Clermont (1095), Mch. 451
 (1130), Ju. 65
 Cloveshoe (742), S 311
 Cologne (346), My. 183, 334
 Constance (1414-18), O. 593
 Constantinople (360), Jan 185;
 Mch. 318 (381), Jan 126;
 F 282-3, Mch 174, 321;
 O. 510. (389), My. 134.
 (394), Jly. 354, N. 510
 (448), the Latrocinium, F.
 333-7. (450), Ap 24: (553),
 O 613, N. 498. (680-1), Jan
 137-8; F. 343; My 175;
 Ju 413-14 (746), F 94-5.
 (754), F 419; N 584. (815),
 Ap. 45. the dedication (394),
 Jly. 384; N. 510
 Epaone (517), Mch. 16; O.
 119
 Ephesus (431), Jan. 307, 425-
 432; F 335, Au. 27; S 152:
 (444), S 152, 157. (447), S.
 152. (449), F. 335-7; Ap.
 148; S 155-7
 Frankfort (794), Jan 436; F.
 423, My 273, Ju 164

- Council of Fritzlar (1118), Ju 59
 Friuh (791 or 796), Jan. 436
 Holmpatrick (1148), N 94
 Iconum (232), S 220; O. 688
 Junque (524), Jan. 18
 Lateran (313), S 232: (649),
 N 295: (1076), My 369-70:
 (1099), Ap 292-3: (1179),
 N. 332: (1116), D 280:
 (1215), O 92-3; D 293
 Leptines (742), O. 354
 Liege (710), N. 79 (726), N.
 79
 Llanddewi Brefi (519-69), Mch.
 11-13; N. 194, 327-8; D.
 128
 London (1076), My. 365: (1137),
 N 359-60
 Lyons (517), O. 119: (1245),
 O 32, 34: (1275), Mch. 152,
 Jly 345; Au. 124, 252, O.
 35
 Macon (585), F. 405; O. 159;
 D. 425: (624), Mch. 500
 Maghlene (630), Ap. 225
 Mainz (1049), Ap. 239-40:
 (1069), F. 391
 Mantua (1053), Ap 242-3
 Marly (678), O 28-9
 Metz (863), D. 202
 Milan (355), Jan 183; My.
 45-6, Au. 388-9; S. 352
 (347), My 43: (451), Ap.
 24: (1565), N. 118: (1569),
 N. 123: (1573), N. 127
 Nicea (325), Jan. 264, 273; F.
 434, Mch. 208; My 33-6;
 Jly 354, 399-400, S. 170-1,
 448-9; N. 50; D 66-7
 (787), F. 420-3, Mch. 216,
 250; Ap. 70; Jly 186, N.
 223-4
 Northampton (1176), Ap. 11
 Oak, the (403), Jan. 406-7, 421
 Orange (441), N. 345, 570-
 (529), Au. 378; N. 346
 Orleans (511), F. 87. (558),
 Mch. 16. (549), Mch. 259;
 D 63
 Oxford (1222), D. 108
- Council of Paris (551), Mch. 259;
 D. 63 (577), F. 403-5; N.
 384. (824), F 423 (1072),
 My. 364: (1092), Ap. 123:
 (1104), D. 255
 Poitiers (1100), D. 250
 Rheims (625), N. 306 (630),
 S. 91 (995), Ap. 311 (1049),
 Ap 239-40: (1094), D 245-
 (1119), Ju. 60: (1148), F.
 27
 Riez (433), N. 570
 Rimm. *See* Arimimum
 Rockingham (1095), Ap 282-8
 Rome (341), Ju. 69 (382), My.
 164; D. 80 (430), Ap 94:
 (503), Palmary, Jly. 451-2:
 (680), F. 242-3: (721), N.
 395 (732), N. 579-80: (799),
 Jly 157
 Saragossa (380), Ap 146; D.
 271
 Sardica (347), Ap. 176; My.
 42-3, 183; S. 172
 Seleucia (359), F. 279; Mch.
 317
 Sens (601), N. 493: (1140),
 Au. 208-10: (1247), D 108
 Seville (590), F. 447: (619),
 Ap. 66
 Sidon (390), D 58
 Sinuessa (apocryphal), Ap. 345,
 348-9; Ju 160; Jly. 452;
 D 416
 Sirmium (351), Mch. 492; S.
 355
 Sutri (1046), M. 352
 Taragona (1235), Jan 358
 Toledo (589), F. 447; Ap 64.
 (633), Ap. 66; D. 115: (654),
 D 218: (656), Mch. 451
 Trent (1545-63), Mch. 148
 Troyes (1104), D. 254
 Trullo, m (680), Mch 451; S.
 137; D. 313
 Tyre (335), My 38-9; S. 171-2:
 (388), My. 38-40
 Vaison (444), Jly. 687
 Vercelli (1050), Ap 240-1
 Verulam (430), Jly. 683

- Council of Vezelai (1146), Mch 211
 Vienne (1112), N 212-13
 Whitby (664), Jan 94; Mch 24; O 299-300; N 393
 Worms (1076), My. 368-9, Ju. 224; Au 104
- Councils, absurd scene in, My 370 · violent scenes in, Mch. 317; Ap 45
- Coverlet given to sick, Jan 376
- Cow, image of, touched by pilgrims, F. 51 · injured, F. 7
 martyr gored by, Mch 112. of hermit, Jan 364; N. 191 restored to life, Mch 332, 438
 suckles a wolf, Jan 364
- Cowardice, charge of, N. 244 · in monk, O. 216
- Cowardly saint, D 213
- Cowherd saints, Jan 146, F. 273, 448, N 17
- Cowl, luminous, S 107
- Cows stolen, F 19, 199
- Cracow taken, Ju 405
- Cradle, betrothed children laid in same, N. 416-17. of S. Herve, Ju 245 silver, N 416
- Crane attacks eyes, N 203-4. *See* Eyes
- Craving in pregnant women, Mch. 70
- Creed, Apostles', Ap 367; Jly. 348-9; Baptismal, My 140
- Crib, Christmas, O. 108-9; D. 276
- Crocodile killed by saint, D. 436
- Cross, apparition of, Mch 314; My. 316; Au. 180-1 borne in procession, F 439, 440 · child led before, Jly. 171 · emblem of, F. 278 · falls from heaven, Jly. 119; hung round neck, Jan. 47 · invention of, My. 56-63; miraculous impression of, Mch. 460 · of fire, N. 352: of S. Andrew, N 598 · same as the Little Horse, F. 276, 278 · sign of, Jan 44, 163, 286, 314; F. 278, 368, 431, S 100, 236-9, 270; O 175 the true, F 360, 436; My. 56, 63-4; Au 133, 170; S 236
- Cross-roads, superstitions about, D. 7
- Crowbar, martyrdom by, Ap 200
- Crowberry wine, N 415
- Crown, Edgar forbidden to wear, My 286: obtained by prayer, Ju 412 of gold given to a church, Jan 123. of thorns preferred to gold, Ap. 379 of thorns, Au 403. symbol of, Aug. 327, 404
- Crucifix, bleeds, N 224 Host put into, S. 52-3 miraculously restored, N 630-1 · moves arm, N 459, 554 moves head, Jly 291 of S Rosalia, S. 54 olive-leaved, O. 151 on stag's head, S. 319: sends message, S. 52 speaks, S 52; O 75 the Book of Saints, Jly 340
- Crucifixion, martyrdom by, Jan. 41, 277, 470; F 147-8, 329, 394, 432; Ap 112; My 55, 332; Ju. 3, 409; N 107, 597 supposed day of, Mch 454
- Cruelty of Spaniards, O 219
- Crusade against Albigenses, Au 48, 52, 186; S 60-1; D. 292-4 · against Christians, O. 582, 594 against Moors, My 422. of Frederick II., N 435-7 of S Louis, Au 291-302, 307-10, O. 99 · preached, Aug 211-12; N 352 · second, Au 211-13
- Crusaders, Au 213, 219
- Crusading Club, S 60
- Crushing, martyrdom by, Mch. 491; Ap. 199, Ju. 19
- Crypts at Hexham and Ripon, O. 304
- Culdees, Jan. 191
- Cunedda, family of, Appdx 23
- Curates wear rectors' cast-off clothes, O 36
- Cures, miraculous, only temporary, O. 591-2
- Cuna, charges of, Au. 89-90

Curse of saint, O 731, xi 591;
 Appdx. 36-7, 173-8
 Cursing well, Appdx 170
 Custody of the eyes, D 56-7

D

"DADSIAS," a death-wake, F. 365
 Dagrinnis founded, Jan 19
 Dalmatia united to Hungary, Ju 404
 Dalmatic assists parturition, O 83
 Dalmatics allowed to deacons, Au 344 · green, N 83
 Damietta, siege of, O 99-100
 Dancing forbidden, N 553-4 religious, Au. 7, 260; N. 177-8, D. 312 · saints, S. 297
 Danegeld Tax, O 342
 Danes die of dysentery, N. 592: ravages of, F. 56-8; Mch. 18, 59, 94-5; Ap. 230
 Darkness, spiritual, N 532
 "Darling's Mug," S. 420
 David's, St., founded, Mch 11; N. 154
 Deaconesses, S. 34, 114; O. 173-5; N. 226: saints, S. 34
 Deacons, aged fifteen, D. 262
 saints, Jan 312-15, 331-4, F. 7-12, 46, 305, Mch. 515, Ap 272; Ju 361; Jly. 127, 286, 500; Au 98, 109-10, 160-1; S. 251-2, 261, 361; O 127-30, 135, 476-7, 725; N. 230-2, 335, 412; D 296-9, 405: seven to be with a bishop, O 643 · the Seven, Jan. 133, 346; Ap. 130; Ju. 55; D. 323
 Dead called on to speak, D. 181: mass for, Au. 363; D. 100: prayer for, Jan. 79: restored to life, Jan 109; F. 284, 307, 352; Mch. 71, 398; Ap. 374; My. 111; Ju. 5, 475; S. 36, 189, 260, 261, 264; O. 67, 305, 619; N. 240, 246, 315; D 67

Death foretold, N. 94 in prayer, Jan 57, S 35, 44, 117, 146, 185: preservative against, O 711: wake, F. 365
 Deceased brother's wife, marriage with, Jly. 189-90: wife's sister, marriage with, O. 119
 Decretals, false, N. 321
 Dedication, Celtic, Appdx 67
 Deer indicate site of monastery, O 138-9 trace boundaries of, O 439
 "Defender of Church," title of, Jan 157
 Deformed saints, F 109, Mch 369; Au 6
 Deformity in answer to prayer, F. 116
 Deira, kingdom of, O 230, 234
 Delay in answering death-call, F 307
 Demon, curious vision of, Ju. 253
 Dempster, errors of, S 35
 Denain founded, Jly. 31
 Denmark, conversion of, F 60-1, 70-1; N 28-30, 32, 39
 Denys (St) built, Jan 49
 Deo Gratias, My. 259
 Deorham, battle of, Appdx 20, 180
 Depression, spiritual, N 532
 Derceto, symbol of, Jly 486, 625; S 258
 Derry founded, Ju. 92
 Derwentwater, hermit on, Mch 356
 Desertion of abbey by abbot, Jan 95; Ap. 123; Ju. 238: of see by bishop, F. 40; My. 118, 185; Ju 57, 259; Jly. 279, S 126, 243, O. 434, 573, 709; N. 232, 313, 338: of wife, My. 409; S. 46
 Deserts of Egypt, Jan 29: of Gaul, Jly. 14: monasteries in, Jan. 224-5
 Despair, temptation to, Jan 444: F. 200 warning against, Jan. 433

- Deutz, monastery founded, Mch. 281
- Devil, assaults of, Jan. 253-4; O 509; N 249-50: at table, My. 144: beats a saint, S 163: carries a saint, Ju. 352: demands adoration, N 251. invades the bowels, N. 250: invited into a saint, F. 191: sits on a collect, O 371
- Devils carry off a king, Jly. 206. caught by the nose, My. 288. dispersed by holy water, O. 373. drown a boy, Ju. 474-5. expelled, O 425, 515, 707. hideous, Ju. 475, 481. jerk a saint into fire, O. 419. pull char from under saint, O 466. red-hot, N 237. silenced by mockery, Jan 211
- Dexter, forged Chronicle of, F. 9, 45; Ap. 181, 250, 300, 325, 359; My. 238; Ju. 304, 367, 464; Jly. 183
- Diamonds fall from mouth, My. 104
- Diana, statue washed, My 247
- Dice burnt, O 591
- Dié, S., founded, Ju. 260
- Diet of Worms, D. 38
- Dinner borne by angels, O. 710
- Dionysian mysteries, O. 196
- writings, O 190-4
- Dionysus Zagreus, O 197
- Dioscorus of Alexandria, Ap. 149
- Diptychs, Jan 420; N. 487
- Dirceto, Jly 486; S 258
- Director in nunnery, Ju. 39 unsuitable, My 103
- Dirty saints, Ju. 339, 417; Jly. 590; Au 190; O. 510, 560; N 584; D. 400
- Discalced Carmellites, N. 528-38.
- Disciples of Christ, Ju. 77; Jly. 282; S. 376; N. 20, 64, 66, 226: of S Paul, Jan. 53, 359; F. 449; Ap. 121; Ju. 386, Au. 34
- Discipline, employed, O. 216; N. 144, 558-60: given to ladies, N. 435, 446-7, 454. relaxed, O 352 strictness of, O 216-7, N. 205, 214
- Discord seen as filth, F. 398
- Discouragement, Au 341
- Disembowelment, Mch. 495; Ju. 20
- Disentis founded, Jly 281
- Disfigurement of saint, F 363
- Disguised female saints, Ap 254; O 200
- Disgusting acts of penance, Jly. 702; S. 255; O. 459, Appdx. 66
- Dishonesty in saint, F. 12, 16
- Dismemberment, Jan 162; F. 411; Mch. 504; Jly 260; S 115, 248, 339, 439; O 118, N. 152
- Dispensations, sale of, Ap 51; Jly 526; N. 365
- Distaff, Ju 218
- Diurna, Bishop, Appdx. 43
- Divorces granted by Pope, F 111
- Doctor illuminatus, Ju 500
- Doe, hermit nourished by, Ju 337; S. 9. measures bounds, O. 439
- Dog, F 44, 371; Jly 123, Au. 42, 157; N 463-4
- Dog-headed saint, Jly 554
- Dogs, martyr cast to, N 15
- Dolphin, Jan 90, S 385
- Domestic life, its sanctity, Jan. 223 love, F. 14
- "Domine quo vadis," Jly 37
- Dominican Order, Mch 122, 125; Au 46-58: in Scotland, Appdx. 197
- Domitian, saint related to, My. 106
- Donations, forged, F. 326, D. 414
- Donatists, F. 259, Mch. 238; Ap 90-4; Ju. 34, Au 366, S 231-2; O 54
- Dorchester, see founded, Jly. 169; D 19
- Double (second-self), Jan. 342; Ju. 185; O 215: monastery, F. 18, 272, 338, 382; 415, 428;

- Mch 175; Ap 165; My. 110; Au. 281, S 339; O 445; N 70, 71, 156; D 113, Appdx. 107-8
- Dove decides site of monastery, O 432 indicates tomb, N 307: oil brought by, O 9 rests on head, Jan 299; F. 13, Mch. 127, 238; My. 76; Ju 90, 604 soul appears as, O 727 symbol of, O. 414, 537, 556 vision of, Mch 237; S. 181-2; O 373, 569, 581: whispers in the ear, F. 13. wine brought by, O 633
- Dover, not at, O. 335
- Dragging to death, N 568
- Diagon, F 191; Mch 226; Ap 373; Ju 35, Jly. 487, 624; S 95; O 25, 26, 258, 417, 436, 516, 632, 633; N. 25, 162, 600; Appdx 182
- Dreams, Jan. 166; F 8, 435; Ju. 34, 90; O. 216, 569, 571
- Dress, gay, S. 269; N 209-10; D 4-5
- Dropsy, My. 425; D. 102
- Drowning, half, F 122; martyrdom by, Jan. 44, 182; F 411, 412; Mch. 8, 57, 468; Ap 14, 38, 61, 176; My. 247; Jly. 127, 162, 166, 168; N 508: recovery from, 5, 36; N. 165: rescue from, Jan. 235; Appdx 169, 177
- "Druidical" monuments, Mch. 224, 298
- Drunkenness in monastery, Jly. 606
- Dryness, spiritual, F. 204; Mch 88
- Dublin, suffragans of, N 333: under Canterbury, Ap 107; Appdx. 61
- Ducks, marvellous, O. 670
- Duel prevented, My 259; Jly. 542
- Dull child, F. 99
- Dumb ox, Mch 128
- Dumbness healed, Ju. 238, 251; Jly. 134, 261; N 253
- Dung-heap, saint hung over, Jly. 137
- Dunwich, Bishopric, Mch. 163
- Duplicity in saint, Jan 473
- Durrow founded, Ju 92
- Dysentery, N. 592

E

- EAGLE guides a saint, O 212. indicates site, Jly 12 protects from sun or rain, F. 139, 242, My. 184, Ju 80 symbol, D. 310
- Eagle's nest, babe in, S 140
- Ears and nose cut off, O 321. of wheat, three, F. 415
- Earth dissolves into blood, S 52: jerks a boy into heaven, O. 615: opens and swallows persecutor, Appdx. 173. turned into bread, S. 181
- Earthen bowl, Jan. 308
- Earthquake, O 517, 615, 689
- East Saxons, Jan. 91; Appdx. 14
- Easter, difference about. *See* Paschal controversy
- Ecceln da Romano, Ju. 185-6
- Echternach, dancing procession at, N. 177
- Ecthesis of Heraclius, N 294-6
- Edict torn down, S. 97
- Edmund the Magnificent, My. 254
- Education of boys, Appdx. 266
- Eggs received as fees, S 97
- Eichstadt founded, Jly. 180
- Einsiedeln, pilgrimage to, My 104
- Eirenarchs, N 87
- Election contested, My. 120, 291; Ju. 383; Jly 449; S. 137; O 636-8: of Bishops, Jan 299. F 12, 363, 370; Ap. 313; My. 108, 109; Ju. 156, 311, Au 316; O. 2, 606; N. 24, 76, 246, 306
- Elephants, O. 666
- Elevation in rapture, Mch 142; S. 297

- Eleven thousand virgins, Jly. 195-7
 Elfreda, story of, Jly 200
 Elgiva, story of, My 283; Jly. 114
 Ehas of Cortona, Ju 187; Jly 336
 Elmet, kingdom of, Appdx. 22
 Elmo's lights, Jan 376, 462, Ap. 207, Ju 21
 Elopement from convent, F 23, 43
 Eloquence, F. 11 · useless without uncton, Ju. 226
 Elves, world of, N 571
 Ely, chapel of S Zita at, Ap. 356. founded, O 444
 Ember season, O 351
 Emperor forbidden admission to church, Jan. 361, D 97
 Empress martyr, N. 541: saint, Mch 52-4; Au. 164-74
 Endura, Mch 80
 Enfants trouvés, Jly 473
 England, conversion of, O 477
 Envy among hermits, Ju 338
 Ephesian Church, O 64
 Epilepsy, saint invoked for, Ju. 334
 Episcopus Episcoporum, O. 691
 Epistles of S. Paul, Ju. 408
 Equivocation, F. 370
 Ermine mantle, O 186
 Eruption on face, My 321
 Etmhadzan founded, S. 447
 Etna, My. 163, Jly 172
 Eucharist, called Never-failing Food, F. 398; carried, Mch 6; S. 410; sent to encourage war, N 522; vision of, O. 570
 Eucharistic sacrifice, F 82
 Eudoxia, Jan. 163, 408
 Eulogæ, Jan. 49, F. 5; Ap. 4, O. 279; N. 473
 Eunuch saint, J. 166; Ju 55
 Eusebians, My 70; Ju 336
 Eusebius, Eccl Hist. of, N 488
 Eutychianism, Jan 154, 309; F. 243, 300-2, 332-7, 451; Mch. 63-4; Ap. 150; Ju 273, S. 152, 157, 190, 322; N 488; D 56-8
 Evangelical demonstration of Eusebius, N. 48
 Everlasting gospel, Mch 138; Jly. 331, 338
 Evil speaking, Jly 8
 Excommunication, ceremony of, Ju 245: of emperor, My 370, 377, 380, 406; Ju. 264; Jly. 55, 375; N 431, 437, 488; D 96 of king, My 112. of monk, Jan. 155; of Pope, N 488 pen dipped in chalice to write, N 293 saints under, Jly 48, 49, 82: unseemly, O 43-5
 Exercise, against evil thoughts, Au 349
 Exposition of children, N 312
 Eye, loss of, F. 16. plucked out, Mch 50; S. 170, 392; O 181
 Eyehds pierced, Jan 416
 Eyes cursed by saint, O 731
 government of, N 109, D 56; healed, N. 236, 288 opened, N 303 sore, N 109; D. 107 transfixed, O. 181

F

- FACE shmes, N 535 (see Illumination). stained, Jan 147
 Facts alleged, S 278
 Faith, self-devotion for, Jan 425
 Falcon in hunting, Mch. 502
 False accusations, S. 167, 194, 264, 338; N. 313. decretals, N. 321
 Famme, relieved, Jan 23; F 11, Mch. 40
 Fanaticism and immorality, Ju 62
 Faremoutier founded, S. 91
 Farne, hermits in, Mch 344, 354, 441, My 96, 327; Ju. 339
 Fasting communion, Jan 407; Ap. 4. excessive, rebuked, F 324; Mch 373. extraordinary, F. 22, 324; Ap 228, 303, 373,

- 426; S 254, 295; N 123; Appdx. 178 on Sundays in Lent, N 215. true purpose of, Au. 331
- Faust and Marguerite, S 388
- Fear of death, F 9; S. 102, D 72
- Feather trimmings, O. 183
- Fees, evaction of, F 332
- Feet, hung up by, D 7 sunk into stone, F. 354; O. 649 trans-fixed, O 155, N 228
- Felicissimus, case of, S 205, 214, 217
- Female society, S Dominic's liking for, Au 43
- Females disguised as monks, Ap 250, O 200
- Fens of Cambridgeshire, Ap 166
- Ferry-boat, Jan 33
- Feudal tenures, My. 119, 229; S. 26
- Fever cured, Ju. 199; Jly 133: patron against, My. 106, S. 326; N. 163: transfer of, F. 102
- Fig-tree, F 263; My. 186
- Figurehead, Jly. 649
- Filoque, Ju. 165
- Finchale, My. 330
- Finger of the Baptist, Ju. 359-60: of S Helena, Jly 699
- Fire carried in the lap, Mch 164; My. 17; Ju. 337; N. 192, 337; Appdx 175: column of, N 302: devil throws saint into, O. 417 falls from heaven, Ju 342. martyrdom by, Jan. 381; F. 7, 232, 316, 330, 348, 411, 412, 444; Mch. 108, 207, 222, 468; Ap. 13, 37; Ju. 411, Jly 205, 207, 210, 278; S 89, 100, 185, 249, 273; O 321, 322, 569; N 211, 218, 335, 458, 519 miraculous escape from, F 101: miraculously lighted, Jan. 188: power over, Ap 28: predicted, N. 214; sacred, Mch. 71; saint invoked against, O 561: used against tempta-
VOL. XVI.
- tion, Jan. 434; F. 23, 290, Ap. 206; Ju 364. vision of, F 384
- Fireworks, O 213
- Fish and book, Jan. 368. and key, Jan. 161; Ju 224, S. 188; O 434: and ring, Jan 192, Ju 438; S. 7 bone of, removed, O 463. carries a saint, S. 358, 385 sent on Friday, S. 123. swallowed, O. 340: tails, My. 390
- Fisherman saint, F 191; Ju 419
- Fishes created, Ap. 60. sermon to, Ju 188
- Flame, perpetual, F. 21: saint rolls in, Ap. 206; vision of, F 355
- Playing alive, Au. 257; N 169
- Flea, Jly. 111
- Flesh, subdual of, Jan 31
- Fleur-de-lys, Ap 352
- Fles cursed, Jly 291: torment saint, Mch 511
- Flirtations, O 360
- Floods, F. 119
- Fly, Ju 249: carries off Host, D 46
- Flowers for altar, Ju. 244, S. 182. of Paradise, N 229, 503
- Fontanelle founded, Jly. 517
- Fontenay founded, Ju. 132
- Fool's cap assumed by a saint, O 583
- Footprints in rocks, F 354; My 385; Ju. 56, 75, 431; Jly. 37, S 40
- Foiest life of hermits, Jan. 325, Jly 13, 14, 124, 490; N. 491
- Forests of Gaul, Jly 13. of Germany, Jly. 359: of Pomerania, Jly. 59
- Forged decretals, N. 321 documents appealed to, My. 26
- Forgery of Acts. *See* Acts
- Forgiveness asked of the dead, N. 156: of trespasses, Jan 352
- Fork marks boundaries, O. 640

- 472, N. 109, Appdx. 252, 258.
cut off to preclude coronation,
N 564 luminous, O. 473 put
on again, Mch 246; N 71,
168 speaks after decapitation,
Jan 45; O. 472; N 465
- Headache, saint suffers from,
Appdx 74
- Heart, blazing, F 447, Ju 215.
cut, O. 411, 413 disease of, N.
159 plunged in that of Christ,
O 466
- Heathen deity, saint inherits sym-
bols of, F 416: governors,
forbearance of, F 430: perse-
cution of, Au 137
- Heaven, many ways to, Jly. 6
- Hedgehog, O. 464
- Helebore, N. 245
- Helgoland, Mch 478; N. 173
- Helios invoked by S Patrick,
Mch 291
- Hell not considered, Jly 141: of
Theodoric, Jly 179 vision of,
Ju 467; Jly 316, 834, O 374
- Henoticon of Zeno, Jly. 100, 420,
449
- Henry IV., Emperor, Ju 264-6,
Jly 46-51, 55
- Henry of Bavaria, Mch 264
- Heraclian, revolt of, Ap. 93
- Hercules, club of, D 8
- Hereford founded, My 309
- Heresy of Eon de l'Etoile, F 27
- Heretical baptism, Au 16, 75, O.
688-92; bishops burnt, F. 294
- Heretics persecuted, Jan 421,
476-8; O. 588, 590, 598; N
236. *See also* Persecution
- Heriot, O 35
- Hermit elected pope, My 292
- Hermits in the East, their customs,
Jan. 29, 154, 203, 223-6; F.
250, 266; Mch 64; Ap 17,
Jly. 522; O. 474, D 54 in
the West, F 388, 453; Ju
258; Au. 81. number in desert,
Jan. 224
- Herma, saint invoked against, O.
284
- Heroism of Christians, My 342
- Hersfeld founded, O. 435
- Hide, martyr wrapped in, O. 625
- Hildebrand, My. 357
- Hildesheim, treasure of, N. 469
- Hind, Jan 288
- Hive, Ap 68
- Holy water, efficacy of, O 373
well, Mch. 438, O 179, 180,
183
- "Homo," term of reproach
- "Homocousios," Jly 355
- Honesty, example of, D 3, 5
- Honey, Jan 350; Mch 225, 291,
471; Jly 606. martyr smeared
with, F 359; Mch 494
- Horn of S Hubert, N 82
- Horren founded, N 108
- Horse, blue, O 669. exchanged
for a girl, F. 98 flayed, My
112. issues from cloud, S 181
killed by touching a tomb, S
183 miraculously obtained, S
101: of S Columba, Ju 125.
saint thrown by, N 237 tamed,
O 353. winged, F. 288
- Horse-boy made bishop, F 24
- Horse-hair shirts and sheets, N
349-52
- Horse-shoes nailed to feet, Mch
273
- Horse-stealing, S. 123-5
- Horse's leg taken off, D 9
- Horses, saint torn by wild, S. 80
- Hospital founded, Jan 123; Ju
388
- Hospitality, Jan. 231; S. 68
- Host, carried on the heart, Jan.
453; Mch 7. infant seen in,
F 311; Au 30. saint adores,
Au. 126 sent to King of Abys-
sinia, O. 663. symbol of, Ju
175
- Hot spring, saint cast into, D. 17
- Household regulation, S 404
- Howling saint, O 489
- Huguenot barbarities, Mch 495;
My 243, 312. destruction, D 2
- Human love overcome (*see also*
Natural affection), F. 100, Mch.

377 : sacrifices, Mch. 43, 363, 364, 410, N 10
 Humility, Jan 18, 63, 78, My. 132, 194, 324, 389, Ju 38, 288, Jly 507; S. 78, 81, 173. grotesque, S 28, O 459
 Hungary, F. 205; S. 20. crown of, S 23
 Huns, Jan. 48, 107, Mch 91, 261; My. 132, 194, 324; Ju 400, 404, Jly. 118; S 156; O 540, 542
 Hunting, bishop's love of, My 288 passion for, O. 340; patron saint of, N 72
 Hurons, Jly. 740
 Husband and wife, mutual love, S. 113, 389, 403
 Husbandman saint, F. 246, 344, Mch 114; N 413; Appdx. 209. *See* Labourer
 Hyæna, Jan 33
 Hydrophobia, N. 177
 Hymns, F 12, 303, 368, D 89
 Hypsistarians, D. 117
 Hyssop at the coronation, Jly 100
 Ilystena, S. 253, N. 242, 537

I

ICE, martyrs exposed on, Mch. 205
 Iceland colonised by Irish, My. 218: conversion of, Jly 664
 Icelandic Church, N. 413 saints, Ap 313, My. 413, N 413, D. 262
 Icicles used as fuel, Au. 184
 Iconoclasm, Jan. 175; My. 98; Jly. 194; Au. 107; O. 138. in West, Mch 235
 Iconoclastic heresy, F. 92-6, 275, 293, 386, 418-23; Mch 216, 249; Ap. 39; My. 98, 177, 201, 420; N. 109, 271-8, 579
 Idiot saint, N 40
 Idleness, evil of, Jly. 8
 Idol broken by prayer, F 440; Mch. 48, Ju 337: falls before

saint, N. 51, 491 in Flanders, Ap 5: in Gaul, N 26: in Sicily, Ap 33 spat on by saint, Jan. 5
 Idolatry, folly of, My 190
 Idols broken by martyrs, Jan 5, 120, 163, 246, Ju. 387, 470, 481, Jly 58, 98, 499; S. 4, 98, 179
 Ignorance encouraged, Au. 124, 197, 207; O. 217
 Illuminati, Jly 720
 Illumination in ecstasy, Jan. 147; Ju. 122, Jly 524, N. 535
 Image kicks off its shoe, O. 131 of B V. M., My 423; Ju. 365, Jly. 275; O. 126, 131, N. 351, 587. of Christ, Mch 251; Ap 34, 43; My 99, 177, 420; Jly 194, Au. 107; O. 126, 131; N. 273
 Images, Mch 243, 250; My 98, 99; Ju 170, 374, 470; Jly. 186, 194, Au. 152: S 52, 165; O. 75; N. 538, 582, D. 95 dressing up of, Au 324; N. 537: reverence to, N 580, 585, 605. saint objects to, My. 167. saint tramples on, Au 232: use of, F 93, 416-8; Mch 235, Ap 20; My 178, 179; O. 453, N 622
 Immaculate Conception, F. 31, 73; D 108
 Immorality and mysticism, Ju. 62
 Impalement, F. 134, Ju 255
 Impediment in speech, Jan. 417
 Imperial placet, N 297
 Impious songs of Arrus, D 66
 Impurity, spirit of, Jan. 252; Au. 337
 Incantation, Christian worship regarded as, F. 298
 Incarnation, F 46
 Incendiarism, Jan. 164
 Incense, Jan. 428; Mch. 242; Ap. 118; Ju 152
 Incontinence, clerical, Ap. 55; My. 223, 265
 Indecent pictures in churches, N.

- 123 : talk reprov'd, Ap. 5, My. 310, O 37 ; D 61
 Independence of bishops, O. 691, of see of Rome, Ju. 415
 India, missions to, N. 610, D. 228
 Indian cabin, Jly 738
 Indians, N. American, Jly. 733-88
 Indulgences, Ju. 58, 142, 255, Jly. 34, 129, 309, 321, 406, N. 430
 Infant offered to monastery, My. 263 · prodigy, D 64
 Influenza cured, N. 492
 Ingratitude, N 441
 Ingulf's Hist of Croyland, Au. 19
 Innkeeper saint, My 246
 Innocents, heads of Holy, O 563
 Inquisition, My 83, 87 ; N 429 at Goa, N 615, 629 : introduced into Aragon, Jan. 308
 Inquisitor saint, F. 45 ; O 586, 587, 596 ; N. 587
 Insanity, saint invoked against, My. 210
 Insensibility to abuse, Jan 222
 Insight, spiritual, S 299
 "Insinuations of Divine Piety," N. 343
 Intemperate speech, F. 258
 Intercession of saints, Jan. 314, 400 ; F. 381 ; Ju 152, 412, N 7-8
 Interdict, My. 113 ; S 287
 Intermediate state, O. 198
 Intolerance, Mch 61 ; My. 84 ; Jly 572 ; Au. 104 ; D 85, 92-5
 "Invention" of relics, Mch. 95, Jly 560 ; S 12, O 62, 122, D. 101 *See* Relics
 Investitures, Mch. 225 ; Ap. 123, 276, 294, 311 ; My 354, 361, 405 ; Ju 263 ; Jly. 49, 51-2, 55-6, S. 729 ; N. 211-3, 478
 Iona founded, Ju. 100
 Ireland, conquest of, by Henry II, N 330 : grant of, by Adrian IV., N 330 ; Appdx 61
 Irish colonists in Iceland, My. 218 : guls, beauty of, N. 489 : missionaries, F 192, 193, Mch 22, 91-3 ; Ap. 376, My 114-6, 137, 346 ; Ju. 280, 373 ; Jly. 38, 97, 187, 188, 261 ; N 59, 170, 489, 570 ; Appdx. 41-2 : pilgrims, O. 326, 575 : recrimination, Ap. 203
 Iron band round body, Jan. 362
 boots, Jly 277. works at Fussen, S 95
 Issue of blood, woman with, Jly 287
 Italians given English benefices, Jly 341 ; O 32 moral backwardness, N 357, 367, 553
 Ithancester, Jan. 91
 Itinerary of S. Peter, N. 488
- J
- JAMES, S., leads army, My. 424
 Jansenism, Jly 477
 Japanese missions, F 141 ; N 640-50, 675
 Jaws broken, My 428 ; Ju 145, 205, 307
 Jealousy among ascetics, Jan 30
 Jersey, My 15 ; O 617
 Jerusalem, pilgrimage to, S 153, 155, 182 : taken by Chosioes, F 359. Welsh visits to, Mch 11, Ju 34 ; N 188
 Jesuates founded, Jly 707 ; O 586
 Jesuits forge a Veda, N 623
 founded, Jly 729 ; N. 603
 "Jesus" on breast, Ap 88
 Jew Pope, Ju 64
 Jewel falls into chalice, S 6
 Jews, accusations against, O 596 ; N 224 : charged with murdering boys, Mch 447, 461, 465 ; My 204 ; O 597 ; N 21 : insulting treatment of, My. 20. persecuted, Mch 462 ; Jly. 592 ; O 40, 586-8, 596, 664 : practice usury, Au 290. riots made by, D. 234 urge on persecution, O 567, 662 ; N. 516

John the Baptist, disciples of, F. 1; Mch 505 relics destroyed, Mch 495
 Jointures founded, Ju 257
 Jordan, sacrifices to, Mch. 43
 Joseph of Arimathæa, Jan 5
 Journey, marvellous, Jan 37, N. 166

Jovinian, S. 459
 Joy, death through excessive, S. 48
 Judges reluctant to sentence, Ju 232 · who communicate, D 92
 Judgment on persecutors, F 203 rash, to be avoided, Jan 356, F 192; Ju 235; Jly 141, 142; S 38
 Judith, Queen Jly 437-41
 Julian bathes in blood, Mch 319
 martyrs under, Jan 371; Mch 408, Ap 131; Ju 234, 309, 369; Jly 209, 210, Au. 225, 279; S. 12, 96, 179, 321 rebuilds Temple, Mch 319
 Julian of Eclona, Ap 140
 Jumping saint, S. 295-8
 Jurisdiction, My 128

K

KAISERWERTH founded, Mch 18
 Kalends of January, Jan 2
 Keuschberg, battle of, Mch 262
 Key, Jan 51 of St Peter, My 184; N. 75, 581
 Kief, Jly. 360, 367
 Kiln, Jly. 531 martyrdom in, Au 262
 King and bishop friends, S 13-17: excommunicated, S 14 repulsed from church door, S 15: turns monk, O 712
 King's Evil, My 16; O. 346
 Kings, three, Jan. 83, 148, 151
 Kirkwall minster, Au 218
 Kiss cures leper, N 147 · objected to, F. 329; S 351, 439
 Kitchen scene, Ap 36
 Knees, impression of, O. 154.

lumps on, O 463: torture of bent, N 335
 Knife, F 380 floats, O 433
 Knight saint, Jan 81; Appdx 249
 Knocking against coffin, F 139

L

LABARUM, Au 180, 225
 Labourer saint, Mch 114; Ap 209, N 413 See Husbandman
 Lac d'Oo, Ju 75
 Ladder, F 209, 210
 Lamb, Jan 321, F 108; O. 96
 Lammas, Au 1
 Lampreys, O 38
 Lamps for churches, Jan 239, F 396; Ju 384: miraculously kindled, My. 105, 152, Ju 384
 Lance, martyrdom by, Ju 178, 252: sacred, Mch 263, 267, S 234
 Landes, Jly 454
 Langensalza, battle of, Ju 224
 Lantern miraculously lighted, Jan 51, 116, 288; My 249 See Lamps
 Lapsed, case of, S 209, 214, 217, N. 544
 Larbouste, Ju 75
 Las Casas, O. 219
 Lastingham founded, Jan. 92-94, Mch 24
 Latrocinium, F 337
 Laura described, Jan 306, Mch. 64; Jly 176; D 56
 Laus perennis, S 339, N 492; D 112
 Law, saint's love for, O 35-42 · school at Berytus, Jan 389, Ap. 12
 Lawyer saint, My. 301; S 397
 Lay garb assumed by bishops, N 141
 Laymen compulsorily ordained, F 12, Jly 682, O 614: invested with ecclesiastical dignities, Mch 7

- Laxity of bishops, N 141
 Lazare, S, College founded, Jly 464
 Lead, molten, martyrdom by, Jan. 38; F. 317; Ju 88; S 12
 Leaded whips, S 246
 Leaden shirt, N 351
 Leaf, saint floats on, Mch 438
 Lech, battle of, S 19
 Leeds, battle near, F. 215
 Leeks, marvellous, S 264
 Le Gras, Mme, Jly 467
 Leg, hamstrung, S 170
 Legal lying, N 235
 Legates, rapacity of, N 358
 Legend, growth of, Jan 383; F. 2, S 399; N. 601: transfer of, D. 76
 Leonine city, Jly. 430
 Lepanto, battle of, My. 60
 Leper saint, Ju 147, O. 560; Appdx. 196
 Leprosy, F 50, 87, 292, 454, Ap 253; Ju. 147; Aug 136; O 617; N. 197, 424, 449
 Lerins, Au 345; S. 41, 414
 Letter concealed in cave, Jan 429
 Letters forged, S 247 of peace, S 211. three, Jan. 176
 Lettres de cachet, Jly. 474
 Leuconay founded, Ap 4
 Levity, Anan, 129-30
 Libellatics, S 199
 Liberius, fall of Pope, Jly. 632
 Lichfield, Jan 28; Mch. 29
 Licinius persecutes, Jly. 257, S 185
 Lige, Ap. 78; N 76
 Lies, 'pious,' Ju. 303; Jly 522
 Life, value of, Au 194
 Light above corpses, Jan. 86; F. 140, 311; Ju. 5, 155; Jly. 31, 699, S 18; O. 278 in ecstasy, Jan 147; F. 382; Ju 122; Jly 524, O 314, N. 55, 62: miraculous, Appdx 171. not extinguished by wind, Jan. 461; F 361
 Lights at funerals, F. 283, 413; Mch 305 carried in procession, F. 283
 Lightning, F. 414; Mch. 119: conversion through, N 564
 saint invoked against, Ju 485, D 28
 Lily, Mch 434: grows from grave, My 293; Jly. 303, N. 40; of Quito, My. 393
 Lime-kilns discovered, Jan 29
 Lincoln founded, O 242
 Lindsfarne devastated, My. 274
 Linen forbidden, O 217 hangings of, D. 68 pattern, N 449 use of, abandoned, O 445 white at communion, F 263
 Lion and splinter, Mch. 64, 274, S. 462 defends hermit, My 187 saint rides on, S. 131 spares a hermit, D. 55 spares a virgin, D 626 symbol of, Mch 66; Appdx. 25, 337, S 463 tamed by Landgrave, N. 428
 Lioness preaches, Ju. 282 protects saint, O. 534
 Lions dig a grave, Jan 220, 383. in Berkshire, O 654
 Liquefaction of blood, S. 303
 Lismore founded, My. 198
 Litanies used, F. 264, 409; Mch 230, Ju 157
 Lithographic stones, D. 21
 Lithuanians, missions to, F. 304
 Little men, saints, Mch. 285, Jly. 698
 Laturgy, vernacular, Jan 154
 Livery, significance of, Au 292
 Lives of saints, effect of reading, O. 359
 Living truth, Au 342
 Llandaff founded, D 15
 Llandewi's Bref, Synod, Mch 11; Appdx. 312
 Loaves, petrified, Jan. 61: symbol of, Appdx 24
 Lobe of ear, babe suckled from, F. 308
 Lobes founded, Ju 212
 Log, man turned into a, Ju. 27
 Lombardy, Mch. 96, N 580

London attacked by Norsemen,
 Jly. 640
 Looking-glass, N 421
 Lotharingna, O 634
 Louis XI, King, Ap. 29
 Love above fear, Jly 141. feasts,
 Au 365
 Lovers, patroness of, Appdx. 175
 Luke, S, pictures by, F. 77
 Lumbago, Au. 350 saint invoked
 against, My 187
 Lumps on knees, S 131
 Lunatics in monastery, Jan 154
 Lure, My 419
 Luther, Jly 717
 Luxeuil, Mch 498; Ap 4
 founded, N 491
 Luxury in bishops, N 141 *See*
 Bishops

M

MACEDONIAN heresy, F 282; O.
 607
 Madeira, Jly 384
 Madman's sermon, F 20
 Madness, Jan 154; Mch 349 in
 saint, F. 166; Ju. 417, Jly 26,
 533
 Maforum, F 430
 Magic, S. 387
 Magician saint, S 387
 Magyars, invasion of, S 19, 423
 Mail coat, saint wears, Ju. 362,
 N. 587
 Malmesbury founded, My 347
 Man, bishopric of, O 498
 Manichees, Jan. 140, Mch 75,
 Ap. 141; Au. 41, 145, 251-3,
 351; N 437: invade Europe,
 Au. 41: persecuted, Au. 41
 Manna in tomb, S 65
 Mantle divided with beggar, N
 242, 261. given to, N. 423, 1).
 337: miraculously sent, N 71.
 used as boat, Jan 358; Appdx.
 32
 Marble converted to crystal, N.
 338. pillar burns, Jly 126

Marcionite martyr, F 7
 Marende, S 40
 Marmion burnt, F. 440; S 120
 Marriage, compulsory, S 28, O
 65 continence in, Jan. 52, 60,
 122, 182; My 12, 344, O
 39-65, 305, 332, 441, 532; N
 151, 161, 503. dissuasion from,
 Jan. 182. escape from, Jan
 146, 376; F 261, 268; Mch
 221, 275; My 277, 321, Ju
 213, Jly. 18, 262, 323, S. 78,
 141; O. 426, 485, 531, 582, N
 197, 203; D 106; Appdx
 298 spiritual, Jan. 52, 60, F
 295, Ap. 119, My 344, 382,
 Au 320, O 395; N. 342, 351,
 537
 Marriages, spiritual relationship;
 bars, N 197 to be celebrated
 in churches, N. 133 within
 forbidden degrees, N. 90
 Married bishops, Jan 44, 58, 182;
 F 13, 81; Mch 173, 457; Ap
 8, 38, 41, 140, 141, 318; My.
 125, Ju 305, 337, 401, 420;
 Au 11, 12, 103, 139, 248, 414,
 416, S 70, 376, O 10, 290, 645,
 699; N 346, 414, D. 117;
 Appdx 35, 67. clergy expelled
 the choir, N 206 deacons, F.
 288: lector, Appdx. 55 life,
 happiness of, S 403. love, My
 344; priests, Jan. 3; F. 259,
 337, 344; Mch 288, 468; Ap
 8, 41, 318, 363; My 223, 271,
 281, Ju 72, 221, 305, 383,
 389; Jly. 113, 267, 296; S
 137, 170, 216; N. 360, 605;
 Appdx 35, 67-8
 Martyrdom courted, S. 100, 113;
 N 217, 335, 459
 Martyrs, a few multiplied into
 many, O. 604; apocryphal (*see*
 Acts, fabulous), do not suffer
 pain, O. 352, 644; N. 20
 show disrespect to judges, N
 520: title loosely applied, Jly
 317; N 413
 Martyrology of Ado, 536. of

- Florus, O. 535 of Hrabanus, O 535 of Notker, Ap 105, O 536 of Usuardus, D 536 of Wandelbert, O. 536 of Whitford, S. 464 of Wilson, S 92, 269, 464. Roman, errors in, Au 223, 234
 Mary, S, acts as midwife, O 185 adversaries of, My. 165. benefit of invoking, O. 359 cakes offered to, My. 165: portrait of, S. 111. visits a saint, N 343
 Masqueraders torment a saint, N 249
 Mass and sermon, respective values, Au 303: assistance at, F 262: congregations attend part only, Jan. 353 fasting before, N 204 repetition, Ap. 146. said easily, O. 228
 Masses, three daily, Jly 117
 Master thief, My 252
 Maurice, S, in Valais, S 333
 Maximilian of Mexico, My 425, Au. 146
 Mazard apples, Ap 192
 Meat and drink, evaporate, N 15. kingdom of God not in, Jly. 155
 Mecklenburg founded, Ju 74
 Media vita in morte sumus, Ap. 101
 Mediation of Christ, Jan. 451
 Medici family, N 111
 Meditation, Jan 343
 Meekness, examples of, F 198, 380; Jly 477, Au 288, 332, 477; O 558; N. 252
 Meletian schism, Jan. 264; F. 278-83; S 455-7; N 545
 Melfont founded, N. 94
 Memory, Jan 35
 Men, virgin may not address, D 68: nor look on, N. 252
 Mendicant orders, charges against, Jly. 380
 Menhir, idolatrous rite at, Jly 608: story of, O. 618
 Merchant saint, Mch 517; Au 5
 Mercia, kingdom of, O 244
 Mercy, in judging, Jly 141-2 sought for captives, N 253
 Merseburg founded, Ju 74
 Mesalliance, O 351
 Metaphrastes, N. 575
 Mice as symbols, Mch 308, Ju 340 earth drives away, Jly 123 festival of, D 7 story of, My 143
 Michael, S, apparition of, My 115, S 435. churches dedicated to, N 22
 Midland English, Jan 91
 Midsummer Eve, Ju 333
 Milk from veins of saint, Ju. 453, Jly 351, 586 heals blindness, S 274 in Irish legends, F 15; Mch 160, 247; Ap 332, 333; Ju. 27; Au 136 man's breast yields, D. 122
 Mill, Jan 310, Mch. 214, Appdx. 201
 Millner saint, Au 325
 Millstone round neck of saint, O 629
 Minims, Order of, Ap. 26
 Minstrales, Au. 193
 Minster in Sheppey, Jly 159 in Thanet, Jly 318
 Minstrelsy, My 349
 Miracles, alleged, but false, N 626, 632 curious, Jan 25, 61, 146, Mch. 50, 71; My. 112, 205, 307; Ju 27, 249; Jly. 10, 11, 40, 120, 135, 281, Au 39, 150, 153, 160, 247; S 49, 52, 163, 187, 251, 278, O 431, N 240, 337, 338. desire for, F. 72; O. 732 doubtful, N 252. explained, F. 2, My. 278, Ju. 32, 184, 246, 363, Jly. 302, 365, 376, 381, Au 12, S. 187, 189, O. 324, 475, 581; N. 23, 71, 72, 139, 169, 208. magnification of, Jan 117; Ju 158, 247; Jly. 376 manufacture of, Jan. 351, 382, F. 2: test of, F. 66; O. 130
 Missions, fruits of, N. 556, 559. preaching, N 553-60

- Mitre, deprivation of, N. 66
 papal, N 94
 Mittens, Jan 116
 Mixed motives, Au 341
 Mob, violence of, S. 148
 Moderation in asceticism, Jan 69
 refusal of, N 488 use of, Jan.
 69; N 110; D 38
 Modesty, O 37 false, Ju 292-
 293; D 68: martyrs to, D 407
 Molten lead, martyrdom by *See*
 Lead
 Monachism, Arian dislike of, Jan
 404
 Monasteries, double, *see* Double.
 given to laymen, F 65; My
 279; Ju. 41 great size of, My
 143
 Monastic cruelty, Ap 122; N.
 539: decline, My. 268, 281.
 friendships, O 282: habit, re-
 verence for, Jan. 391: laxity,
 F. 197, 201, 428, S. 41: life,
 attraction of, Jan 11, 33; Ju
 262, 378; Au 227: love, Jan
 12, 150, 174; F 250; Mch.
 245, 472; Ap 267; N 193:
 violence, Jan 419; F 200, 253;
 S. 41; N. 210, 473
 Mongols, Au. 152
 Monks, customs in Egypt, Jan.
 29-30; F. 266: desert their
 monasteries, Ju 237; Jly. 23
 dissolute, Au. 282; O 500, N
 126: gluttonous, N. 204: jea-
 lous, N. 191, 210, 220, 337,
 347: poison abbot, Jan 87,
 337; Mch 391, 414; S. 363:
 turned out by nuns, O. 558:
 warlike, F. 30
 Monophysite heresy, Au. 272, 275;
 S 152
 Monothelite heresy, Jan 137; F.
 342; Mch 215; My. 175; Ju
 413; N. 293-6
 Montanist heresy, Ju 15, 407;
 Au 311; O. 351, 688, 717
 Montjoie, S Dens, O. 197
 Montmorency family, O. 197
 Montserrat, Jly. 711
 Moorish martyrs, Au. 223, 226,
 234 persecution, Mch. 218-20,
 254
 Morat, battle of, Mch 429
 Moravians, conversion of, Mch
 180
 Morini, Mch 288
 Mortar, cast into My 224 mar-
 tyr brayed in, F 410
 Morte d'Arthur, Mch 37
 Moscow, churches of, Au. 265
 Moss, saint overgrown with,
 Appdx 183
 Mothers, good, F. 10; Ju. 136:
 prayers of, F. 106
 Mother ill-treated, O. 333 of
 God, My 129. wheeled about,
 F. 221
 Motley's "Netherlands," Jly 212
 Mount, S. Bernard, Ju 214
 Mozarabic liturgy, My. 359
 Mule, Ju 188 restored to life,
 S 121
 Munster sacked, O 57
 Munsterbilsen founded, Jly. 192
 Munsterthal founded, F 362
 Murder attempted by monks, F
 197, 266; S. 362; N 122
 Music, ecclesiastical, Ju. 223. in
 England, Au 80: love of, O
 97: miraculous instruction in,
 My. 285. patroness of, N 505
 school of, Jan. 171
 Mutilation of corpses, S. 164 of
 males by Alexander III, Ap
 11: of saint's body, O 409-13
 Mystery, a vestment, O. 212
 Mysticism, Jly. 334
- N
- NAIL given by Christ, O. 397,
 414
 Nails, found with relics, S 331;
 D 9, 101. in feet of martyrs,
 Mch 46, 273; Ju. 88, 251;
 S 99; O 155; N. 228. in
 temples, N 164: of the Cross,

- My 61; N. 136 symbol of, S 107
 Nails, splinters driven under, O. 629
 Nain, widow's son of, Au 255
 Naked saint, O 488, Appdx. 183.
 Nakedness, virgin sentenced to, O 698, N 311; D 27
 Name of Jesus, My. 311
 Names revealed in dream, N. 186: used in witchcraft, S 104
 Natural affection overcome, Jan 11, 78, 203; Mch 425; Ju 235, 487; Jly 605; Au 333, S 79, 345, O 531, 557, 699, N. 446, 489, Appdx 250; lack of, N. 351
 Nature, love of, F 195
 Neck of saint invulnerable, O. 633
 Necromancy employed, O 644
 Needlework, ecclesiastical, My. 278
 Negro saint, Ap. 59; Au 348
 Nepotism, episcopal, Jly. 122
 Nero at burning of Rome, Ju. 335 reappearance predicted, N. 251
 Nervin, Mch 107
 Nestorian heresy, Jan 309, 422-31, Au 26, 27, S 152, 321, O. 607-12, N 488
 Nets, introduced in Sussex, O. 308, martyr enveloped in, Jan. 182
 Netad, battle of, Jan. 107
 New year begins, F. 27, 305
 Newmunster founded, Ju 76
 Newport, Appdx 203
 Nicknames, My 274; Ju 208, Jly 327
 Nicodemus, crucifix by, F. 78 gospel of, Mch 266
 Niebelungen Lied, Jly. 202
 Nightmare, Mch 291
 Nine at a bath, My 333; Appdx 292. maidens, Jly 358; O 324
 Nitrian desert, Jan. 29
 Nixes banished, O 420, 423
 Nizabis, siege of, Jly 353
 Noetian heresy, O 347
 Noise, dislike of, Jly. 491 to be avoided, F 379
 Nommalists and Realists, Ju 261
 Non-residence, N. 116, 141
 Norman treatment, of Saxons, My 327 of Welsh, Appdx. 56
 Norsemen, F. 57, 243
 Northumbria, conversion of, O 240
 Nose comes off, Au 49 cut off, Ap 253; Au. 284; S. 138, 392. miraculous bleeding of, O 496
 Notaries instituted, Jan 38
 Noth-helper, the Fourteen, S 10
 Novatian heresy, Jan 134, 166, Mch. 56, 172; S. 197-202, 205, 214, 216; O 606, 689; N 317, 545
 Nuns, demoralised, Mch 69; Ap 55, My. 286; S 142, N. 313, 328, 353, D 103 directorship of, Ju 39; Jly. 340. dissolute, Au 282; O 500; N 234, malice of, My. 10 try to escape, D 107
 Nurse, love for, Ju. 133 martyr or saint, F 286, 361; Ju 208, 221; O. 685
 Nursery tale, My 333; Ju 154, 270
 Nut merchant, F. 298
 Nut-tree planted, O 303 produces fruit miraculously, S. 378 saint buried under, O 572
- O
- OAK, used as oratory, Jly. 455. worship of the, Jan 81
 Oaths abrogated by Pope, Mch 415
 Obedience, instances of, Jan 69, 78, 467; Mch. 115, 244, 484; S 275, O 381; N 221, 550; virtue of, F 263; My. 155, 195
 Oblates founded, Mch. 198; N 129

- Obotrites, Ju 73
 Obsequiousness, episcopal, My. 175
 Observants, reform of, O 589
 Octave observed, O 202
 Odin, hanging to, Mch 363
 Odoacer, Jan 107
 Oil, at ordination, Ap. 53. boiling, martyrdom in, Mch 482; Ju 412 miracle wrought with, F 256; Ju. 84; N. 253; D 67 water changed to, O. 702
 Olive, the, founded, F 256
 Oppressive sanctity, Ap 62
 Oracles cease, Jan 361
 Orarium, Jan. 136, Mch. 44
 Orb, imperial, Mch 53
 Ordeal by fire, Jly 298; S 65 curious, My 153
 Order of Annunciation, F 111
 Calatrava, F. 30 Carmel, N 527
 Celestines, My 296
 Charity, Mch. 167: Chartreuse, O 142, 146-9: Gullemites, F 255
 Mantellates, Ju. 268
 Our Lady of Mercy, Jan 472; F. 229
 Passionists, O 477
 Preachers, Au 51. Premontre, Ju 61
 Theatines, Au 90
 Trinitarians, F. 228
 Vallumbrosa, Jly 292
 Ordination, Celtic, peculiarity in, Appdx 45, 254: in prison, Jan 4
 Organs, saunt with, N 505
 O Rex gentium, My 285
 Origenism, Jan 403; Mch. 208; My 165-9; Au. 272; S. 413, 461
 Orphanage, Jan 124; My. 303
 Orthodoxy, Feast of, Ju 206
 Otters lick saunt's feet, Mch 363
 Oven, saunt enters, Jan 37; F 214; O 67; N 347; D 53
 Owen's cross, Mch 24
 Owls, white, Ju. 363, 459
 Ox, symbol of, Jly 261; O 470
 Oxford, riots at, O 34; N 362. under interdict, N. 363
- P
- PADERBORN, F 159
 Padlock through eyes, Au. 402
 Pain bénit, Au 365
 Pain intolerable, Jan 12
 Painter saunt, F. 386
 Palatine Counts, My 270
 Pall given, to Archbishop of Canterbury, My. 387, O 242 to Archbishop of York, Ju 84 to Bishop of Bamberg, Jly 52 to S. Norbert, Ju 66
 Pall, meaning of, Appdx 257 unconsumed, O 130
 Palm-tree, Ju 154
 Palmary Council, Jly 524
 Pandarist, F 116, 118
 Pange lingua, My. 151
 Pantheon converted, My 345, N. 2
 Papal abdication, My. 298, 352 claims, My 359, 367, 377 degradation, My. 351, 353: election, contested, My 120, 191, Ju. 64, 271-2; Jly. 450; Au 202. imperial control over, My. 200, 352. encouragement of persecution, N. 430 encouragement to revolt, My 120, 122, Ju. 264, 265, 294, Jly 438, N. 211, 241; D. 39: exactions, Ap. 51, O 32-4: greed of gold, N. 352, 357, 361, 365, 367 interference with election, Ju 84 pretensions resisted, Ju 383, 384, 392, 395 in England, Jly 341: sanction of abuses, N 367
 Paralysed saunts, Jan 133, 147, Mch 239; My. 427; Jly. 524; O. 282, 288
 Paralysis cured, Ju. 478; O 520; N. 96; D 81, 307
 Paris vaut bien une messe, N 66. treaty of, Mch. 127: university of, Mch 129; Ap 50
 Parishes, Rome divided into, O. 643. England divided into, S. 312

- Parrot story, Ap. 246
 Partridge, roasted, restored, S 163
 Parturition assisted by a dalmatic,
 N 83
 Paschal controversy with Celtic
 Church, Jan 93, F. 39, Mch.
 24, 342, 355; Ap. 225; My.
 379, 388, Ju. 4, S 307, 359,
 379; O. 300; N. 304, 493;
 Appdx 186 controversy with
 East, Jan 379; Ap 219; My.
 349, 388; Ju 408; Jly. 596;
 O 701 fine, Mch 71, 296
 Passionists founded, O. 477
 Passover, man in whose house
 celebrated, S 1
 Patavia, Ju. 460
 Paten recovered from sea, Mch.
 362 - sent from heaven, F 237
 Patience, example of, My. 193
 Patricians, Roman, My 353; Ju
 416
 Patrick, reputed relations of, F.
 178, N 321 three of name,
 Mch. 304
 Patrimony of Apostles, N. 580
 Patrpassians, Au 312
 Patron, choice of, N 431
 Patronage, how obtained, O. 643
 Paul, S., Albigensian doctrine
 concerning, Mch 77. disciples
 of, Jan. 359, F. 312, 339, 449;
 M 406, Au 24, 34, 84, 261;
 S. 87, 395; O 61, 190, 195,
 258, 319, 724; N 331-3, 486,
 501, 506, 578; D 331-3: re-
 garded as apostate, F 81:
 relatives of, O. 257. vision of,
 O 665
 Paul III and Charles V., D. 96
 Paul of Samosata, heresy of, Jly.
 93; O 693-6
 Paulician heresy, Jan. 140, N
 285, 431
 Pawnbrokers, nation of, D 65
 Paximatum, F 199
 Peasant saints. *See* Husbandman
 saints
 Pedlar saint, My. 326. landgrave
 makes partner of, N. 427
 Pelagianism, Jan 441; Mch 11;
 Ap 137, My 338, Jly 600,
 635, 683, Au. 372-4; S 414,
 402
 Pen, symbol of, F 449; Mch 210
 Penance, severe, Ju 39 short,
 Jly 141. should be light, Ap
 22, 339
 Penitence, royal, S 15; D 402
 Penitent thief, Mch 456
 Penitential of Theodore, S 309
 Penitents, Jan 136, 156, 433, F
 371; Mch 2, 276, 456, Ap
 19; My 191; Ju 130, S. 172;
 O. 167-77, N 221
 Pennies, three, F 252
 Pens, martyrdom with, Jan. 370;
 Mch 494; Au. 130 plunged
 in chalice to write excommuni-
 cation, N 293
 Pentecost, Jan. 433
 Pepin assumes crown, Mch. 270
 Perfidy, episcopal, N 542
 Perpetual fire, F. 22, Mch 71, 78
 Persecution, by Arian Vandals,
 Mch 411-13, 440, 496, Jly 310-
 16; Au. 159; S 89; O 287-90,
 416, 645; D 69. by Arians,
 Jan 11, 12, 14, 183, F. 446,
 Mch 174, 213, 371; My. 134,
 168, 182, 319, 395; Ju. 70, 200,
 286, 496, 606, 721; N. 164.
 by Calvinists, Jly. 212-50: by
 Catholics, Jan. 446; F 446,
 Ap. 147: by heretics, O 606,
 N 429-34; D 78, 93. by
 Iconoclasts, Jan. 175, F. 92-7,
 275, 386; Mch 217, 249, 311;
 Ap 39; My. 177-80; Ju. 205,
 Jly 194; N 584-6. by Mace-
 domians, O. 607 by Moors,
 Mch. 219, 254; S. 251, 279;
 O 575; N 525; by Novatians,
 O 606. by Quartodecimans, O.
 606: by Saracens, Ju 72; S.
 251, 279: disapproval of, Jly.
 305; O 610; N 255-7, 285,
 587; D 51, 91 exhortation to,
 D 60 of Arians, Jan 421;
 My 134, 168; N. 510: D. 60,

93. of Donatists, Au 368, 371, 374 of heathen, Jly 654, S 22 of heretics, Jan 419, 421; My 134, 168, 312, 395; D 58: of Jews, Jan 419; Jly 462, 592. Au. 212; D 59, 234 of Manicheans, N 487 of Montanists, D 59 of Samaritans, D 59. to be avoided, My 131
- Perseverance, Jan 69, 90
- Persia, martyrdoms in, N. 566-9
- Personalities in preaching, D 62
- Pestilence of, 664; O 282 saint invoked against, Au 157
- Peter, S, chains of, Mch 514, Ap 2. chair of, Jan 275; F 365. daughter of, My 427, N 105 disciples of, Jan 398, 424, 439; F 211; Mch. 1, 407, Ap. 33, 358; S 1, 35, 230, 396; O 51, 152, 631-3; N. 66, 506, 590; D. 220, 404 gospel of, O 718 key of, My 184, N. 75, 581 picture by, F 77
- Petition to infant Jesus, F. 113
- Pets, singular, O 709
- Phallic idol, Ap. 33 worship, D 8
- Phantom ship, Mch 73; S. 116
- Philip, S, daughters of, S. 43
- Philo Judæus, Ju. 425
- Physician saint, Jan 465; Au. 149; S. 399 female, O 257
- Physicians, judicious avoidance of, D 117. papal inhibition of, My 84
- Pictish saint, O 721, N 201
- Picts, conversion of, S. 262-4, 379; D. 12
- Picture-book, Jan 343
- Pictures in Anglo-Saxon churches, Jan 170, 335, in churches, Jly. 423, O 501; N 414. influence of, F. 378, 407; Mch 178, 235; sweat, Au 319
- Piety, precocious, D. 64
- Pigs, Mch 225. restored to life, S 36, 49
- Pigskin sent from heaven, S 174
- Pilgrim saint, Mch. 225; N. 62: killed, O 326
- Pilgrimage, Ju. 218, 313; N 555 not always advisable, N 538
- Pillar burns like candle, Jly. 126 of light, Jly. 428; O. 179 straightened, F. 223
- Pincers, My. 288
- Piper saint, Mch 156
- Pirate saint, Au 219
- Pirates, My 97; O 518
- Plague, F 449; Mch 210, S 216, O 282. in Gaul, D 62 of Milan, N 130-9, of Palermo S 55
- Playing-cards burnt, O. 591
- Ploughboy bishop, Mch 257 saint, My 147, 258; S 181
- Plough diverts river, Mch 327
- Ploughing, miraculous, My 148, S 181
- Ploughshares, ordeal by, Mch 53; O 338
- Pluralists, F. 445; Ap. 99, 100, 240, My. 183, Au. 190; O. 34; N. 116
- Poems, sensuous, N. 536
- Poet saint, O. 354; N. 536 ecclesiastical, N 286
- Poison rendered innocuous, N 548; D 310; Appdx. 161
- Poisoning by a priest, Mch 39; by monks, Jan 377; Jly. 604
- Polish missions, F. 203
- Pomerania, conquest of, Jly 57
- Poor Clares, reform of, Mch 98, 101, 182
- Pope absolves from oaths, Au 188. appointed by emperor, Ju. 274: boy, Ap 233; charged with adultery, Ju 352, Jly. 450: conciliatory, Jly 449, 453. condemned by saint, O 690-2 correction of, N 499 cruelty of, S 392: deposed, My. 352, 367. disobeyed by saint, Ju. 383-4, N 341: encourages rebellious sons, Ju 365; Jly 46, 55, 438; N 211, 341, 431; D. 39. heretical, Ju. 414-15, 464: honours paid to, My 121, 123. kingdoms given by, Au. 185; N. 330: murder

- of, by rival pope, Ju 279 mutilation of, by rival pope, S 393, N 475 · poisoned, My 353; S 393, N 483 · prayed to death, Jly 379: reverses another's decrees, F 26-7 simoniacal, Ju 274: tried before emperor, Ju 160; Jly. 450
- Popes issue conflicting judgments, F 26-7; Ju 272, 289, 415; Jly 329
- Popular canonisation, Jly 359: veto on election, O 646
- Populicians, Mch 75
- Porpoises eaten, My 338
- Porridge boils miraculously, S, 19
- Porringer, silver, Mch 277
- Port of Gaza, O. 355
- Porter of heaven, O 301
- Portrait of B V. M., F 79, 80 of Christ, F 73-9 of saint taken in vision, S. 57
- Possession, healing of, O 425, 515, 632; of Apostolate, My 206
- Pot, child put into, Mch. 158
- Pottenstein, N. 442
- Poverty, evangelical, Ju 236; Au 123
- Practical jokes, Jan 113, 145, Ap 103, Jly. 374, 405
- Pragmatic sanction, Au 305
- Prague, Mch. 182, O 731
- Prayer, constancy in, F 476: for death of heretic, O 476: for the dead, Ju. 317, N 46, 88; instruction in, Jan 222 · saint dies in answer to, O. 258
- Prayers, numerous, N. 353
- Preachers, preparation of, O. 221
- Preaching, attractive, N. 559 · by abbes, N. 343 · by deacons, Jan. 331 effect of, Jan 453; My 159; O. 101, 584: neglect of, N 435 · office of bishop, Jan. 290; Au 41, 51, 364 prepared, Ap. 87; Au 249: reading needful for, N. 552 simplicity in, Au 23; O 172 too frequent, N 415
- Prebend held by layman, Ap 7, 205
- Precedence, Jan 18
- Precocious piety, O 213
- Predestination, Ju 254-8, S 415-17
- Pregnancy, assistance in, Jly. 123; S 40, N. 83
- Pregnant nun, O 500
- Preputium sacrosanctum, D 8
- Pride humbled, Ap 98; My 194, 196 spiritual, Jan 150
- Printhood compulsorily conferred, My 127
- Priests hamstrung, Jan. 143 murderers, Jan 319
- Primacy of Canterbury, My 387
- Prime instituted, Ju. 194
- Priscillianist heresy, Ap. 146; N 254-6
- Prisoners, patron of, N 161 release of, Jan 414; N 160
- Processions, Jan. 362, 428, 440; F. 283, 361, 438; Mch. 230, 280, My 108, 187, 430, Ju. 157; Jly. 324
- Procrastination, episcopal, My. 270
- Procurations, Jly. 266, N 364
- Prophecy fails, My. 377, Ju. 252 fulfilled, Jan 16, 108, Ju. 134, 239 of S Edward, O 345
- Prophetess, O 689, 717
- Prosper of Riez, My. 339; Ju. 353, 358, Jly 685
- Prostitute reclaimed, Jan 136, 156; F. 371; Mch. 2-8; Ju 365. *See* Penitents
- Protestant intolerance, Jan. 446, Ap 332
- Prufening founded, Jan. 87
- Psalms, sitting to sing, F. 390
- Psalter, Gallican, O 296 learned by heart, D. 53 recited daily, Jan 387, F. 388; Mch. 218, N. 350
- Pucelles, les deux, N 591
- Pure love, S. 6

Purgatory, Jan. 27; Mch 106,
Ap 93; Ju 476; Jly 534; O
216, 220
Purse, marvellous, F. 252

Q

QUARTODECIMANS, O 300, 606,
N. 58
Quatuor Coronati, N. 185
Quentin Durward, F. 109
Quern grinds marvellously, N 165
Question, F. 332
Questions, idle, S 390
Quicklime, martyrdom in, My
224 put in mouth, D. 727
Quicunque vult, My. 340
Quincy founded, S 250
Quito, lily of, My. 393

R

RABBIT, Au 81
Rabble, violence of, S. 60; D. 86,
88, 94
Rack, use of, F. 8
Radbod, Mch. 364, Ju 155
Radgast, Ju. 73
Rain, protection from, Ju 377.
sent miraculously, F. 438; My.
17; S 56, 116; O. 513
Raising the dead, Jan. 109; F
252, Mch 351, 398; Ap. 28;
My. 111
Ram's horn, martyrdom by, My.
420
Ramsey, Au 250
Ran, human sacrifice to, Mch 364
Rash judgment, Jan. 357; S. 38
Rats, martyrs devoured by, Jly
274; Au. 99, 100
Ratzeburg founded, Ju. 74
Ravens, Jan 327, 334; Jly. 520
Ray of light decides episcopal elec-
tion, O. 2. gloves, &c., hung on.
See Sunbeam
VOL. XVI.

Real presence, belief in, Au 309
Realists and Nominalists, Ju 261
Rebaix founded, Au 263
Recluses, F. 32, 207; Mch 97;
Au 28
Redbeast restored to life, Jan
188 brings ear of corn, Jly. 28
Redemption of captives, Jan. 95,
471
Red-hot iron, saint carries, N. 23,
32 walking on, Mch 53; O.
338
Reed, splintered, torture with,
Mch. 491, 515; Au 36, 99
"Refutation of Heresies," Au.
234, 312; O 347, 350-2
Regionary bishops, F 183, S 122
Regular canons, My 224
Reichenau founded, N 84
Relapse and recovery, Jly 141
Relic, doubtful, objected to, Au
133. worship opposed, Jan 271
Relics, abuse of, O. 59: bleed, S
164; O 63, 68, 116; N. 12
curious, My. 109; Jly. 585;
Au. 110; S. 231; O 184, 413;
N 248, 310, 563, 565; D. 8, 116-
disgusting, Au 110, 259; O
68; N 158, D. 8: doubtful,
O 321; D 8, 9, 90, 101, 103:
erroneously attributed, Jly 309:
genuineness, how determined,
O 58: greed for, S 148; O.
409-13, 464, N 58; D 72,
116. invention of, F. 376, 433;
Ju 220; Jly. 128, 129, 285, 356,
404; S. 12; O 62, 321, 563;
N 169, 503, 628; D 8, 90, 101,
103: jumping, O. 642, 729: not
separable, D 101 saint with
three or more arms, Au. 259;
S 259, 324; O. 165, 389. with
three or more eyes, O. 31.
with two or more bodies, F
241; Ap. 2, 15, 23, 129, 130;
My. 19, 159, 160; Ju. 177;
Jly. 135, 136, 139, 140, 243,
426, 487, 509, 530, 551; Au.
114, 157, 159, 163, 258; S.
118, 169, 259, 389, 401; O. 470,

- 473, 627, 630, 656, N 565, 598 with two or more heads, Ap. 130; My 4, 160. Ju 142; Jly. 487, 520, 530, 551, 569, S 259, 389; O. 30 spurious, My 238; Ju. 220; Jly 128, 129, 285, 356, 405; S 54, 463, O 122, 224, 286, 357, 547-56, 563, 572, 598, 623, 644, 703-7; N. 248 substitution of, by forged acts, N 565. theft of, Ju. 359, Jly 691; S 164, O 323, 454, 521, 619, N 339 traffic in, D 116 worship of, Jan. 383, F. 5, S 100, O 52, 218, 275, 481, 570, N. 12
- Remi, S, consecrated, Ap. 239
- Remiremont founded, S. 194, D III
- Repentance, sincere, Jan. 79
- Resignation, Jan 391. of see, My 134
- Responsibilities cast off, N 351
- Restraint of tears, My 172
- Resurrection body, O 372
- Revelation of S. John quoted, O 320. preposterous, O. 551-6
- Revenge to be left to God, Jly 143
- Reverence, exaggerated, Mch 119
- Rhampsinitus, My. 252
- Rheumatism, O. 648, D 47
- Rictiovarus, Jan 85; Ju 146, 190
- Ridicule, saint objects to, N 209
- Right of way, F. 18
- Rights, tenacity in clinging to, N. 207
- Ring, F. 225, 295; Mch 44. and bishop, Jan. 294, 298 betrothal to B V. M., N. 351. betrothal to Christ with, Mch 163, N 342: carried off by raven, N. 99: carried up to clouds, Mch. 44. wedding, Au 304
- Ripping open of martyr, Mch. 495
- Roasting, martyrdom by, Ju 146, Jly 510 See Grate
- Robber, conversion of, Au 348; N. 244. saint murdered by, Jan 329; O 248. revered as saint, N. 248
- Robe falls from heaven, Jly. 530; N 71
- Robin redbreast brings corn, Jly. 24
- Robur or Lignum, S 290
- Rock opens to receive saint, D 27 removed by saint, Mch 306, S 13. sacred, desecrated, S 187
- Rod, broken, F 201: of Jesus, Mch. 306
- Rogations, My 151, Jly 21
- Roman martyrology, absurdities in, Jly 351, 407, 408. errors in, My. 253, 307; Ju. 1, 79, 129, 299, Jly. 3, 4, 5, 27, 135, 137, 170, 282, 285, 321, Au 176, 223, 234, S 100, 385, O 125, 192, 352, 416, 464, 471, 500, 698, 703-7, N. 53, 224, 307, 562-4, 578, D. 129 obedience, Celtic Church reduced to, Jan 44, F 217, Mch 342; Appdx 44-55. usages, Jan 93-4, O. 298-9
- Romans, early Christian, Jan 70, 121, 317, 389, F 88, 176; Mch 2; Ap 15, 34, 301; My 58, 66, Ju 207, 270, Jly 185, 203, 433, 527, 553, 613, Au 77, 109, 113, 129, 267, S 168, 173, 176, 184, 258, 386, 437, O 347-352, 621-7, 643, 698; N 149, 150, 502, 540, 541; D. 10, 413
- Rome, appeals to, O. 293, N 207 beauty of, Jan 13. bribery in, N 207. burning of, Ju. 334 Church in, corrupt, Au 89 city of mystery, O 684. early Church in, N 506 judged by her works, N 196 mission of Lucius to, D. 13 pillaged by Attila, Jly. 600 pillaged by Charles V., Au. 92. pillaged by Genseric, Mch 412; Ap. 161: visited in dream, Appdx. 196
- Romney, battle of, Jly 644
- Rooks regarded as devils, N 350
- Rosary, festival of, My 90. in-

stitution of, Au 50. introduced, Au. 50, O 420 of S. Rosalia, S 56 symbol of, Ju 406
 Rose, festival of, Ju. 80
 Rose and apples from Paradise, F 177: bread changed to (*see* Bread) of S. Francis, Mch 391. shaken from sleeves, Mch 414
 Rosina (S. David's) founded, Mch. 11; N. 154
 Roskilde founded, N. 39
 Royal encroachments, My 266: preserves, Jly 266 race, saints of, Jan 34, 53, 118, 134, 138, 187; Ju. 71, 90, 249; Jly. 278: Appdx. 35; supremacy, My. 271; Ju 163
 Rugu, Jan 104
 Rule of S Benedict, Au 15: S. Bridget, O 188: S Bruno, O. 149. S Casarea, Jan 167 S. Casarius, O. 67. S Columbanus, N. 492; D. 107. S. Comgall, My. 142 S Fintan, F. 374. S. Francis, O. 105: S. Molua, Au 38 S Pachomius, Jan 30; My. 192 S. Romanus, F. 453 hermits of Fontevellentino, F. 388: life, Jan 96: monks in Egypt, Jan 29 Saxon monasteries, Jan 92
 Ruptured saint, Ap. 218
 Rush-mat weaving, F 263
 Russia, conversion of, Jly 361-9
 Russian saints, Jly. 360; S 122, 381, N 511

S

SABAS, S., monastery of, Mch. 366
 Sabbatarianism, Jly. 653
 Sabbath, observation of, Jan 29; Ju 152; D 54
 Sabellian heresy, Jly. 355, 402; O 347
 Saccudion monastery, Ap 70
 Sack, martyrdom in, Mch 8, Ap. 38, S. 385: of sand, Ju 235

Sackcloth worn, D 68
 Sacred Heart, feast of the, O 466
 Sacrifice, human, Mch 43, 364. the ascetic life is, Mch 115
 Sacrilege avenged, F 64
 Sacristan saint, S 182
 Saddle, N. 205
 Sailmaker saint, F 10
 Sailor saint, My. 326
 Saints, disreputable, F. 331; My 201, 398, Ju. 154, 367, 389, 406; Jly 8, 90, 125, 128, 264-274, 501: O 499; N. 37, 288, 467-84: doubtful, Ju. 304, 417, Jly. 165, 533; Au 4, 107, 214; O 312-14, 413; N 300-4 heretical, O 496-3 manufacture of, F 376; O 703-7 popular canonization of, N 248
 Saintship, hereditary, Appdx 35-6
 Salency, festival at, F 80
 Salisbury cathedral built, D 48. Plain, massacre on, Ju. 203
 Salt, boatload of, F 289
 Samaria, woman of, Mch 336
 Samasks, F 116
 Sanctuary, emperor not allowed in, D. 94
 Sand bag, F 192. pit, martyrdom in, O 627
 Sandy beach, obtained by prayer, Mch. 224
 Sangreal, myth of, Mch. 37; Jly 166; O 9, 633
 Sapor, persecution by, Ap. 260, 298; Jly 352; Au. 36
 Saracens, Au. 119, 125, 420; S 42; O 510, 531-5; N. 166
 Sarcophagi, My. 209, Jly. 129, 192, 285
 Sarcophagus used by saint, Mch. 497; O 447
 Satan, compact with, F. 89
 Sauve-Majeure founded, Ap. 75
 Saxons, arrival of, Appdx. 13: bishops deposed, Jan 292: subjugation of, Mch 477-8; N 199
 Scab miraculously cured, Ap. 117
 Scandal, Au. 338

- Scapular, origin of, My 226; Jly 407-8
- Scete, desert of, Jan 29, 71
- Schaffhausen founded, Ap 114
- Schism, vision of, F. 21, N. 547
- Schismatic ordinations, My 131, 167, 170
- Scholastic theology forbidden, N 342
- Schoolmaster saint, Au 130; N. 187
- Schools kept by hermits, Ju 242
- Slaves, conversion of, Mch 176-182
- Slavonic translation of Scriptures, Mch 177
- Scolding, forbearance better than, Jly. 142
- Scots (Irish), Jly. 28; N 302; cannibals, S 452
- Scottish Church refused to submit to York, Ap 11
- Scourging, martyrdom by, Ju. 305; Jly. 355
- Scratching, abstention from, O 560
- Scriptures carried on back, F. 256
conversion through reading, O 320, 621
destroyed, O 566-7, 571, 601-4
Latin version, Jan. 88; Mch 322; S 457:
learned by heart, O. 510
reverence for, Ju. 2, 46; Au 117, S 37
study of, Jan. 95; F. 380; Mch. 621.
the voice of the Church, O. 566
- Scrofula healed, O. 346
- Scrofulous boy, kindness to, N 448.
saints, F 330; Mch. 513, Ju. 216, 369; S 292; O 465
- Scrupulosity, grotesque, Au. 32, 81; S. 250
- Sculptor saint, Ju 78
- Scurrlity to be avoided, D. 61
- Sea cow, Jan. 468: divided, N. 303:
horses, Ap 204: monster, Jan. 468; Appdx. 161:
sickness, Jly. 456
- Sebaste, forty martyrs of, S. 132
- Second-sight, Jan 263, 267; O 279
- Self conceit rebuked, Au 340
contemplation, danger of, Au 342
denial, example of, Jan 29
no escape from, S 173
torture extraordinary, Au 318, 327;
Appdx 66 will, Jan 309; F. 381, Au 341
- Selfishness corrected, F 380; Au 38
monastic, Au 334
- Semi-Arians, Mch 492; My 124
See Eusebians
- Semi-Pelagians, My. 339, Ju 354-6
- Sempringham, Order of, F. 101-5
- Sensual thoughts, My 382; Jly 305
- Sequences composed, Ap 101
- Serapium destroyed, Mch 284
- Sergius Paulus, Mch. 406
- Sermons, written, Ap 320
- Serpents expelled, N 84, gigantic, O 517
kept as pets, N. 230
killed by saint, Mch 73; O 417, N 25, 26, 600.
power over, F. 120, Mch 63, 73, My 108, 137, 215, 323;
Jly 204
protects bodies, O. 649
symbol of, F. 335; Mch. 305, Ju 221, N. 25.
turned to stone, O. 179;
unearth corpse, N 25
worship of, F. 318, 342; My 2
- Servant-maid became abbess, O 283
saint, Jan. 394; F. 31, Mch. 457; Ap 354; My. 10, 332, Ju. 10, 68; Au. 136; S 17, 240, 272; O 117
- Servants, troublesome, Ap. 135
- Server, Christ acts as, D 72
- Servia, saints of, N. 287-9
- Service of others, Ap. 118: on board ship, N 612
- Seven deacons, Jan 133: sleepers, Jly 172, 197
- Sex, change of, O 655
- Shade, miraculous, F. 50
- Shaftesbury founded, My 255
- Shamrock, Mch 297, 306
- Shaving extraordinary, Mch. 435

- Sheep bleats after eaten, Jly 11
 "Shepherd" of Hermas, My 124
 Shepheid saint, Jan. 20, 72, F. 220; Mch. 165, 337; Ap 3, 59, 218; Ju. 455; S. 98; N. 292
 Shepherdess saint, Jan 47, My. 145; Ju 216; S 98, 101, O. 416
 Sherborne, Jan 119
 Shield painted, Jly 272
 Shift of saint assists delivery, Ju. 321
 Ship of Isis, O. 545: scuttled, martyrdom in, D 278: symbol of, S. 74
 Shoe cast off by image, O 131 cures hysteria, N 129 devil threatened with, Ju. 253. given in marriage, Jan 279. one off, Appdx. 290
 Shoemaker saint, F 438; O 628
 Short cuts, F. 19
 Shroud, lummous, O 282 sacred, see Sudarium: weeps, O 729
 Shuttle, F 14
 Sickingen founded, Mch 92
 Sickle in sky, S. 242, 245
 Sieve, water carried in, Jly 264
 Sight interferes with meditation, F. 20
 Sign of Cross, Jan 286
 Silence, advantage of, Au 340
 Silk sent to bishop, N. 230: trade, O. 665
 Silver cradle, N. 416: cup, Ju. 254 hand, Jan 45: plate, Jan. 255; S. 193, D. III: statue, Jan 163, 408
 Silversmith saint, O. 198
 Simon Magus, Ju. 425-8
 Simony, Jan. 87, F. 206; Ap 8, 235, 279, My. 354, 359, Ju. 157, 223, 275, 392-9, Jly 294-301; D 35
 Sin, none without consent of will, Ap 37
 Sindon, Jly 166
 Singing attracts boy, My 189, 197
 Sinuessa, council of, Ap 345
 Sister-in-law, marriage with, O 119
 Sisters of Charity, Jly 408
 Sithieu founded, S. 72
 Sitting for psalms, F. 390
 Skewer through ears, S. 172
 Skewers. See Spits
 Skiff of Isis, O 545 of S Ursula, O 544
 Skin stained, Jan. 147
 Skull, F 272 drunk from, Mch 41 of S Teilo, Appdx. 181
 Slander, saint suffers from, Jan 48, S 5, O 702
 Slate from heaven, Au 182
 Slave becomes priest, Jan 166 girl saint, My. 332; Ju 10, 68, O. 117. saint sells himself as, F. 258; Au 402
 Slavery in France, Jan 396
 Slaves kept by clergy, N. 257. redemption of, My. 216
 Sleep, curtailment of, N 587 miraculous, O 622 necessity for, S 420. talking in, Jan 23
 Sleepiness, saint suffers from, N 143
 Sleepless ones, Jan. 232; F. 92; S 321
 Sleepy, Ju. 132
 Slippers worshipped, O 412
 Sloe wine, Au 39
 Slow fire, martyrdom over, Ju. 349 See also Grate
 Slowness at Mass, Ju 174
 Sluggard kings, N 73, 77-8
 Smuggling of balsam, Jly. 178
 Snakes and S. Godnan, My. 323: of Verdiana, F 23
 Sneezing not ominous, D 6
 Snow balls, F. 309; Mch 297: burns, F. 309. falls over virgin martyr, F. 277; O 133. miraculous fall of, My. 142: shaken off as testimony, Ap. 5 tithe of, Jan 243
 Soldier saints, F. 190; Au. 129, 177, 221, 225, 315, 329, S 132, 329-37, 441, O 480, N. 216-18, 239, 242

- Soldiers, Roman, ments of, N 241
 Solignac founded, S. 91; D. 5
 Solitude, love of, O. 522-5, 617
 Solstices observed, D 7
 Somasque founded, Jly. 49
 Song schools, Ap 96-7
 Sorrel, F 308
 Spade symbol, Ju. 485
 Spanish hagiologists, Mch 44
 Sparrows cursed, Ju. 360
 Spear, F. 287, 363, 395, S 277; D 234
 Spidei, Jan. 200; Au. 30; N. 548, symbol of, N 548
 Spike, saint rests her head against, O 488
 Spirit of impurity, Jan 252
 Spiritual marriage, F. 295; Ap. 163 (*see* Marriage). pride, Jan 150. relationships, N 197, D. 18 sisters, Jan 402
 Spiritualists, party of, Jly. 338; O 589-90
 Spiritualities given to laymen, My 256
 Spits, symbol of, O. 728, N 66 through ears, S 173, O. 727: through heart, N. 66
 Spittle changed to gold, My. 145 cures leprosy, My. 142 splits a rock, My. 145
 Sponge for purifying water, O 474
 Sponsors, O. 173
 Spoons, Au 55
 Spring miraculously elicited, Jan. 45, 414; My 152; Jly 260, 264; S 192, 274; O 53, 179, 284; N. 66, 68, 70, 189, 192; D 158; Appdx. 165, 174, 214, 252, 295, 299
 Staff becomes a tree, F 193; S. 181, O 181, 264, 444, 619. bishop's, embedded in tombstone, Jan 295: brought from Paradise, Ap. 195. buds, Jan 442, F. 192; Mch 284, 439; Ju 247; Jly 30, 477, 555; O 708 elicits spring, Jan 45, 414; My. 152; S. 192, 274; O 53; N 66, 68, 154 (*see* Spring). of Jesus, N 92 of S Columba, Jan 192 of S Cuthbert, Mch 352. of S Lambert, S 278; N 75; of S. Patrick, Mch 300; of S Peter, S. 230 of S Vincent, Mch. 209
 Stag protected by saint, Jan. 287; Mch 35; N 154 tramples on serpent, Mch. 14: used in place of horse, Jan. 2, 19; F. 238; Jly. 24; N 155: with cross between horns, S 319, O 129 with luminous horns, N. 104
 Stag-beetle, Appdx 171
 Stags, Jan. 365; S 319, 368-9; N 73, Appdx 177, 200
 Stamping iron for wafers, Ju 134
 Standard of Bretwalda, O 244
 Stanz, Mch 430
 Star, miraculous, My 145; S 164 symbol of, My. 236; S 165
 Starvation, martyrdom by, F 262, Mch. 268, S 46
 Station, a fast, Jan 313
 Statue thrown down, Jan 120, 163; My 300
 Statues at Constantinople, D 82 at Rome, D. 85. sermon on, Jan. 401
 Steps, fifteen to Temple, N. 487
 Stigmata, F. 295; O 112
 Stockings miraculously dried, Jly. 120
 Stocks miraculously broken, D 625
 Stole binds dragon, O. 558; N 25, carried to heaven, Mch. 44. of S. Oswald, F 456. pulled off deacon, O. 68 sent from heaven, N. 75, 81. used for hydrophobia, N. 81
 Stone, executioner turned to, S. 260; feet impressed in, O 649 feet soldered into, N. 15. hands impressed in, Appdx. 189 impressed by knees, Appdx. 190 impressed by person of saint, Au. 384: moved by prayer, S. 13

Stone, miraculous cure of, O. 59
 operation for, Ju 172 saint
 suffers from, Ju. 173
 Stones, saint pelted with, Ju. 175
 saint sails on, Ju 211 symbol
 of, Ju. 143; D 299
 Stoning to death, Ap 34; Ju.
 141, 172; Jly 136; D 297
 Stork, Ju 105, Jly. 59 pecks
 out eye, Mch. 160; D 222
 Storm, circular, N. 654. miracu-
 lous, Ju 172
 Strangulation, martyrdom by, Ju.
 70; S 131, 266, N 289
 Strathclyde, Jan 189
 Strenæ, Jan 2
 Stripes administered in dream,
 F 40
 Sturgeon bears saint, Jly 263
 Styles, or iron pens, Jan. 371;
 Mch. 494
 Stylites, Jan. 71; My 410; Jly 173
 Subjugation of flesh, Jan 31
 Submerged cities, O 618
 Submergence of Gwaleod, Appdx.
 159
 Sudarium sanctum, F 78; N. 139
 Suevi, conversion of, D 8
 Suffocation, martyrdom by, Jan
 175, Ju 177 *See* Strangulation
 Suicide, martyrdom by, Ju 89
 Summons before God's throne,
 N 488
 Sun does not set, S. 378. shines
 on S Eskiel, Ju. 172. shines on
 S Gregory, My 133
 Sunbeam, clothes hung upon, Jan.
 19; F 19, 223, 284, Mch 37;
 Jly. 155; S. 195 decides elec-
 tion, O. 2
 Sunday celebration, F 259, 260;
 O. 200, Appdx 76 hunting,
 Jly 200 rest, Jly. 65
 Superstition, book against, N 84:
 sermon on, D 6
 Surgery, barbarous, Jan 459;
 Ap 74
 Swallow, devil in, O. 504
 Swan, symbol of, Ju. 487
 Swearing, habit of, Au 354

Sweden, missions to, F 61, 310
 Swineherd, Jan. 280; My 196;
 Jly. 455. saint, F 192, 387;
 O. 561
 Synod of Victory, Mch 12
 Syracuse plundered, Mch 511
 Syrian deserts, N. 54

T

TABENNA founded, Jan. 150;
 My. 192
 Taborites, O 594
 Tailed men, My. 390
 Taille, La, N. 81
 Talkativeness among nuns, Jan
 388 excessive, Mch 507; N
 549, 552
 Tall brothers, Jan. 405; My 168;
 Jly 5
 Tangermunde, battle of, Ju 73
 Tankelm, heresy of, Ju 62
 Tannhauser myth, O 708
 Tapers, F 214
 Tapestry miraculously preserved,
 O 398
 Taurobolia, Mch. 319
 Tax-gatherers, S. 323
 Tears, gift of, Ju. 320; S 80
 symbol of, Jan 142
 Te Deum composed, Au. 361
 Teeth extracted, Ju 349, Jly 412,
 O 118
 Temper overcome, F 10
 Tempest allayed, Mch 442
 Temple converted to church, My
 345; N. 2, 218; D. 54
 Temples destroyed, F. 438, 440;
 Mch 284, 298, 345, 475, 494,
 515; Ap. 131; Au 137-9; S
 96, 120, 187; N 166, 248
 Temptation, how escaped, N. 221
 how met, Au 337, 341. how
 not to be escaped, S 173: of
 hermits, N 249. overcome by
 fire, Jan. 434; F. 23, 290; Ap
 206; Ju 364
 Tenderness for souls, Au, 335, 338
 Tentmaker saint, Ju 432

- Testamentary disposal of see, S 158
 Theatines founded, Au. 91
 Theatrical representation forbidden, F. 424, N 123 · representation of baptism, F. 443
 Theban Legion, Jan 235; F. 341, 454; Au 61, 315; S 2, 331, 441; O. 224, 357; D 46
 Theoderic the Goth, Jan. 13; My 395; Jly. 179
 Theodosius, baptism of, My 131
 Theologic rancour, My 389
 Theophilus of Alexandria, My 168
 Theophorus, F. 1
 Theotocos, My. 129; O 609
 Thessalonica, massacre at, D 96
 Third Order of S Francis, O. 104
 Thorn in foot, O. 258 myth about, Jly. 10
 Thorns, crown of, N 560
 Thoughts read, Mch 486
 Thrasimund, My. 14
 Three Chapters, heresy of, Au 272-9; N. 498
 Three pence, F. 252
 Thrones cast down, Jan. 138 · prepared in heaven, O. 169
 Thumb preserved from decay, S. 270
 Thunderclap, saint dreads, O. 462 utilised by preacher, N 559
 Tides at S. Malo, N. 336
 Tilbury, Jan. 91
 Tile kills a saint, Ju. 287
 Time, a year passes as a day, My 212
 Timidity, martyr suffers from, Au 18
 Timothy the Weasel, Jly. 99
 Tithes, My. 274, 415; Ju. 36: martyr for exacting, N. 548
 Titles or parishes, O. 643
 Toads, My. 289
 Toe nails worshipped, F. 301: of S. Zita, Ap. 356
 Tolbiac, first battle of, F. 179; Ju 24 second battle of, S 90; N. 498
 Toleration, My. 395; D 78: protest against, D. 78, 88-9
 Tomb of S Martin discovered, N 259-61. saint born in, F. 349
 "Tome" of S Leo, F 335, Mch. 149, 151-5; Jly 421; Au 78; S. 158 · of S Proclus, F. 331; O 611-13
 Tomtit, Ju 238
 Tongue bitten off, S 176: cut out, F 320; Jly 98; S 273, 392 incorrupt, My. 236; S. 463: pinched, F 258
 Tonsure, Celtic, S 305, 307, 359, 379; Appdx 183: controversy over, O. 300 · Eastern, Jan. 129
 Tooth, F 233 · of Buddha, N. 563
 Toothache cured, F. 206, 233
 Torch lit by wayside, D 7 symbol of, N 218
 Torture abolished, S 424
 Touching the garment, Appdx 161, 188
 Toulouse cursed, N 590
 Tournai cathedral wrecked, Jly. 219
 Tours, monastery of, N 258-60
 Tower, symbol of, Jly. 531; D. 28, 67 · virgin inclosed in, D 25
 Transfer of land, symbol of, F. 51
 Transformation, marvellous, S 440
 Transitus Mariæ, Jly 175
 Translation by angels, Jly 138; D. 132-5 · miraculous, Jly 192
 Transport in ecstasy, N 166
 Transylvania conquered, S. 26
 Travels in the East, Jan. 211
 Treasure trove, F. 369
 Tree blooms in winter, Jan 117; Mch 47 · diverted in falling, F. 207, N 248 · hanging on, My 13 · restored miraculously, O. 284 · worship, Jan 81; F 342; Ju. 45; Jly 412, 681; N. 66, 248
 Treves, Ju. 69
 Tribur, Diet of, My 372
 Trinitarians founded, N 485
 Triptych, N 352
 Trisagion, O 616
 Troitska monastery, S 382
 Trough, stone, used as boat, D. 123

Trumpet, symbol of, Ap 88; My. 311
 Trust in God, My 261; Au 95
 Truth, indifference to, Ju 303; Jly 522
 Truthfulness, example of, O 503
 Tunic of mail worn, F 356
 Turks, war against, preached, O 598
 Tusculum, Counts of, Ap 233
 Twelve weepers, N 306
 Twins, F 250
 "Type" of Constans, N. 293-6, 298, 300
 Tyrol, martyrs in, My 418, Ju. 370

U

ULCERS sucked, N 606
 Umbrellas, Jan. 13
 Umhlati dissolved, N 121-3
 Uncumber, S, Jly 487
 Universal bishop, F 421, Mch 232; pope, S 191
 University of Paris, Mch 129; Jly 327-33
 Unstrut, battle of, Au 131
 Urochs worshipped, D 17
 Ursula and her virgins, S 52, 257; O 285, 495, 571-3
 Ursulines, My 430
 Uses, abolished, N. 90: local, N. 87
 Usury contracts annulled, N. 123
 Utraquist schism, O 592-6

V

VAIN knowledge improved S 390
 Valentinian heresy, S 173
 Vandalism, Christian, Au 138-40
 Vandals, Jan. 10, 14; My. 334, Au 378
 Vanity, mortification of, Au 21; of worldly pomps, F. 107. rebuked, My. 194. saintly, O. 60
 Varallo sacro monte, N. 194
 Vedas, N. 623

Veil, angel gives, O. 53 miraculously restored, O. 129. of S Agatha, Jly 172 of S. Veronica, F. 75
 "Venator animorum," Au. 95
 Venatores, Mch. 111
 "Veni Creator" composed, Ap 101
 Venus of Quimply, N. 26
 Vernacular hymns, D 56 liturgy, Jan 154; Mch 179, O. 592
 Vessels of altars of gold and silver, O 566: sold in famine, Jan 23, 407; Mch 315, 412; Au 15 sold to redeem captives, F. 98
 Vestal virgins, O 623
 Vestment at baptism, Mch 315 at communion, F. 263: eucharistic, Jan 15, 135, 138, 248; Ju. 170; Appdx 73
 Vesture, holy, N. 181
 Vesuvius, eruption of N. 588
 "Vexilla regis," when first used, Au 134
 Victor, Pope, Au 311-12
 Victory, altar of, D 82-5, 95, 99
 Vigilantius, heresy of, S 459, 460
 Vigilus, Pope, Ju 272-9, Au 291-8
 Vine poles, martyrdom by, Ju. 129
 Vinegar and salt for wounds, Mch 222
 Vines in Gaul, Jly 15. introduced, Jan 322
 Violence of Catholic mob, D. 86, 88, 94: of martyrs, Mch 409, 410
 Violets, Mch. 240
 Viper, F. 343, 368; Ju 450
 Virgil, book of, Jan 368
 Virgin Mary, B, acts as midwife, O. 185 annunciation, Mch 450 assumption, Au 141. beauty of, O. 195: devotion to, Jan. 341; F 90, 106. immaculate conception of, D 108 nativity of, S 110 purification, F 34
 Virgin, consecration of, Jan 48 disguises herself as monk, F 268; Ap 254-9, Jly 424-6, S. 167, 320, 351, O 200-2.

- given up to insult, Jan 120; My 206, 246: of questionable repute, O. 258, 499 suckles a saint, S 274 title loosely applied to, O. 500
- Virginity, form of dedication of, F. 261, 267 of B. V. M. maintained, D. 116
- Virgins consecrated among Teutons, Ju 343
- Visions, Jan 5, 36, 123, 144, 197, F. 196, 381, 396, 397, 401, 435, Mch 88, 98, 104, 106-9, 206, 230, 292, 424, 509, Ap 61, 78, 80, 115, 117, 118, 120, 372, My. 104, 286, 289, 381; Ju 51, 253, 269, 338, 401, Jly. 30, 52, 95, 126, 143, 197, 269, 401, 412, 489, Au 30, 52, 95, 111, 150, 180, 197, 269, 322; S. 57, 90, 102, 117, 159, 161-3, 174, 253, 280, 287, 319; O. 58, 111, 171, 185, 198, 216, 282, 287, 310, 366, 369-74, 394, 408, 466, 483, 509, 579, 583, 605, 648; N 13, 201, 242, 250, 302, 312, 316, 317, 323, 342, 441, 554-6; D 41, 47, 48, 62, 72, 116, 231, 297. of heaven, S 159 of hell, 360 of S Gregory, F. 240 pronounced to be hallucinations, N 251, 312: to be discouraged, S 454
- Visitations, episcopal, My 270
"Vitæ Patrum," F 264
- Vituperation, saintly, Au 108; O 274, 594
- Vogt, Ju 310
- Voice from heaven, O. 474 lost for whipping a chorister, N 24-sweet, S 5
- Voluntary martyrdom, F 277, 402; Mch. 444
- Votive legs and arms, Jly. 19
- Vow, curious form of, F. 225; evasion of, O 667-9 made in fear, F. 9: of child to monachism, F 215
- Vows, popes release from, O. 458
Vulgate made, S 412, 458
- W
- WAFERS, stamping iron for, Ju 134
- Waiblingen founded, N 96
- Waist, burial to, N 502
- Walcheren, idol worshipped in, N 173
- Waldenses, Jan 358; F. 45
- Wandering Jew, Mch. 507
- Warwick, church at, N. 328
- Washerwomen, a warning to, Jly 352
- Wasps, martyrdom through stings of, Jly 166, 598
- Watchbox, saint lives in, N 328
- Water brought from rock, Mch 256 (*see* Spring). drops hollow a stone, Ap. 65: flows from relics, N 139 gives up what fell into it, F 202 saint stands in, Mch 218, 340; O 715, N 67; Appdx 66, 204 turned to blood, Jly. 135 turned to oil, N. 24 turned to wine, Mch 220, N 23. used for wine at Mass, O. 730. walking on, Jan 234, 350, Mch. 161, 364, 393, Ju 57; O 654
- Wax candles, ends of, used, F 422: saint beaten with, Mch. 325
- Ways to truth, D. 83
- Wearmouth founded, Jan. 169; S 379
- Weasel, Ju. 407
- Weaver bishop, F. 12
- Weaving of work of life, Mch. 201
- Wednesday fast, Jan 313
- Weeding out vices, Ap 105, 215
- Weight of saint burdened with visions, D 47
- Well, Jan 462. child raised from, O. 475 holy, Jan 45, 51, Mch 439, My 240, 321, Ju. 297; Jly. 324; S 268; O. 179, N. 155, 189, 194, 202, D 122, Appdx 165, 174, 181, 189, 206, 252, 258, 266, 268, 295, 299 saints heads thrown into, N 21

- Welsh Church, independence of, F. 240; Appdx 46-8
- Wends, Jly 268
- Weregeld, O 439
- Werewolf, Appdx. 166
- Westminster founded, O. 343
- Whale, Jly 381
- Wheel, symbol of, N 471, 542
torture of, Ap. 111; My 205;
N 541
- Wheelwright's son bishop, N 450
- Whpcord round head, torture by,
Mch. 258, 496
- Whipping as penance, O 41: of
abbess, Mch 280 of monk,
Mch 516 of novices, O 217.
of saint, O 714
- Whitby, Jan 94; F. 219
- White garments, Jan 413, F. 109,
263; O 202
- Wife, desertion of, Au. 25; S. 46;
N 252, 290, 349; Appdx 250.
encourages her husband, S 114:
hermit regrets his, N 252.
heroic, S 113 ill-treatment of,
O 336. love of, O 699
- Will of God, submission to, My. 382
- Willow produces apples, F. 308
- Wills proved, O 46
- Winding-sheet, holy, F. 78; N
139
- Window, martyr thrown from, N.
326
- Windpipe torn, My 420
- Wine diluted by taverner, Mch
253: fountain spouts, My 101.
miraculously increased, N 177,
179: water turned into, 460
- Wings, symbol of, Ap 88
- Witchcraft, priest burnt for, N. 142
- Withern founded, S 263
- Wolf, Jan. 377, 468, F 19, 106,
108, 181, 308; Mch 71; Ju
35, 57, 246, 363; Jly. 132,
199; S 180, Appdx. 177, 178:
brings head to saint, N 202
carries off child, O 576. carries
sticks, N. 338 killed by ass, D
21: ploughs for saint, N 202
protects head of saint, N. 465
spares saint, N 491 suckles
saint, S 180: symbol of, S. 40
- Wolves in England, My 329, S
139 saint devoured by, Au 136
- Woman barren, S 40. direction
of, N 656-8: disguised as monk,
Jan. 71, Jly 424; S. 167, 172,
320 (*see* Virgin) her vocation,
D. 68: not seen for forty years,
O 640 reforming influence of,
Au 354
- Wood buds miraculously, F. 17
(*see* Tree) petrified, F 41
- Wooden churches, F. 326
- Woolcombers, patron of, F 48
- Work, blessedness of, Mch 392
- Worldly goods, D 111
- Worm extracted and hung up in
church, O 433
- Worship, meaning of, F. 422
- Wounds healed, O 270; N 15
- Wren, Jly. 15
- Wrsts, suspension by, S. 132, 146,
D. 69, 199
- Wurzburg, Jly 189

Y

YELLOW death, Appdx. 182
York, first church in, O. 241

Z

ZAGREUS, rites of, Mch 409
Zeal, intemperate, D 66. kindles
coals, N 337
Zealots, sect of, O. 672

